

SOLAS

CONSOLIDATED EDITION 2020



INTERNATIONAL
MARITIME
ORGANIZATION

SOLAS

CONSOLIDATED EDITION 2020

Consolidated text of
the International Convention for
the Safety of Life at Sea, 1974,
and its Protocol of 1988:
articles, annexes and certificates

Incorporating all amendments
in effect from 1 January 2020

First published in 1992 by the
INTERNATIONAL MARITIME ORGANIZATION
4 Albert Embankment, London SE1 7SR
www.imo.org

Seventh edition, 2020

Printed and bound by CPI Group (UK) Ltd, Croydon CR0 4YY

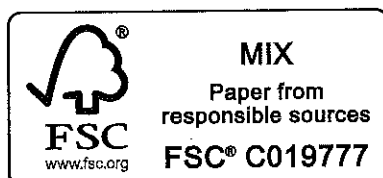

ISBN 978-92-801-1690-8

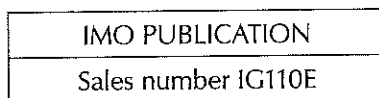

Copyright © International Maritime Organization, 2020

All rights reserved.
No part of this publication may be reproduced,
stored in a retrieval system, or transmitted in any form or by any means,
without prior permission in writing from the
International Maritime Organization.

Reproduction and/or translation rights may be available for this title.
For further details, please contact IMO Publishing at copyright@imo.org.

This publication has been prepared from official documents of IMO, and every effort has been made to eliminate errors and reproduce the original text(s) faithfully. Readers should be aware that, in case of inconsistency, the official IMO text will prevail.

Contents

Part 1

Articles of the International Convention for the Safety of Life at Sea, 1974	3
Protocol of 1988 relating to the International Convention for the Safety of Life at Sea, 1974	11
Consolidated text of the annex to the 1974 SOLAS Convention and the 1988 Protocol relating thereto	
Chapter I	General provisions 19
Chapter II-1	Construction – Structure, subdivision and stability, machinery and electrical installations 37
Chapter II-2	Construction – Fire protection, fire detection and fire extinction 159
Chapter III	Life-saving appliances and arrangements 285
Chapter IV	Radiocommunications 327
Chapter V	Safety of navigation 347
Chapter VI	Carriage of cargoes and oil fuels 387
Chapter VII	Carriage of dangerous goods 399
Chapter VIII	Nuclear ships. 413
Chapter IX	Management for the safe operation of ships 421
Chapter X	Safety measures for high-speed craft 427
Chapter XI-1	Special measures to enhance maritime safety. 433
Chapter XI-2	Special measures to enhance maritime security 445
Chapter XII	Additional safety measures for bulk carriers 459
Chapter XIII	Verification of compliance 477
Chapter XIV	Safety measures for ships operating in polar waters 483
Appendix	Certificates 491

Part 2

Annex 1	Certificates and documents required to be carried on board ships	551
Annex 2	List of resolutions adopted by the SOLAS Conferences	573



Foreword

Introduction

1 The International Convention for the Safety of Life at Sea (SOLAS), 1974, currently in force, was adopted on 1 November 1974 by the International Conference on Safety of Life at Sea, under the auspices of the International Maritime Organization (IMO), and entered into force on 25 May 1980. It has since been amended twice by means of protocols:

- .1 by the Protocol adopted on 17 February 1978 by the International Conference on Tanker Safety and Pollution Prevention (1978 SOLAS Protocol), which entered into force on 1 May 1981; and
- .2 by the Protocol adopted on 11 November 1988 by the International Conference on the Harmonized System of Survey and Certification (1988 SOLAS Protocol), which entered into force on 3 February 2000 and replaced and abrogated the 1978 Protocol, as between Parties to the 1988 Protocol.

2 In addition, the 1974 SOLAS Convention has been amended by means of resolutions adopted either by IMO's Maritime Safety Committee (MSC) in its expanded form specified in SOLAS article VIII or by Conferences of SOLAS Contracting Governments, also specified in article VIII, as follows:

- .1 by the 1981 amendments, which were adopted by resolution MSC.1(XLV) and entered into force on 1 September 1984;
- .2 by the 1983 amendments, which were adopted by resolution MSC.6(48) and entered into force on 1 July 1986;
- .3 by the April 1988 amendments, which were adopted by resolution MSC.11(55) and entered into force on 22 October 1989;
- .4 by the October 1988 amendments, which were adopted by resolution MSC.12(56) and entered into force on 29 April 1990;
- .5 by the November 1988 amendments, which were adopted by resolutions 1 and 2 of the Conference of Contracting Governments to SOLAS 1974 on the Global Maritime Distress and Safety System and entered into force on 1 February 1992;
- .6 by the 1989 amendments, which were adopted by resolution MSC.13(57) and entered into force on 1 February 1992;
- .7 by the 1990 amendments, which were adopted by resolution MSC.19(58) and entered into force on 1 February 1992;
- .8 by the 1991 amendments, which were adopted by resolution MSC.22(59) and entered into force on 1 January 1994;
- .9 by the April 1992 amendments, which were adopted by resolutions MSC.24(60) and MSC.26(60) and entered into force on 1 October 1994;
- .10 by the December 1992 amendments, which were adopted by resolution MSC.27(61) and entered into force on 1 October 1994;
- .11 by the May 1994 amendments, which were adopted by resolution MSC.31(63) and entered into force on 1 January 1996 (annex 1) and on 1 July 1998 (annex 2);

- .12 by the May 1994 amendments, which were adopted by resolution 1 of the Conference of Contracting Governments to SOLAS 1974 and entered into force on 1 January 1996 (annex 1) and on 1 July 1998 (annex 2);
- .13 by the December 1994 amendments, which were adopted by resolution MSC.42(64) and entered into force on 1 July 1996;
- .14 by the May 1995 amendments, which were adopted by resolution MSC.46(65) and entered into force on 1 January 1997;
- .15 by the November 1995 amendments, which were adopted by resolution 1 of the Conference of Contracting Governments to SOLAS 1974 and entered into force on 1 July 1997;
- .16 by the June 1996 amendments, which were adopted by resolution MSC.47(66) and entered into force on 1 July 1998;
- .17 by the December 1996 amendments, which were adopted by resolution MSC.57(67) and entered into force on 1 July 1998;
- .18 by the June 1997 amendments, which were adopted by resolution MSC.65(68) and entered into force on 1 July 1999;
- .19 by the November 1997 amendments which were adopted by resolution 1 of the Conference of Contracting Governments to SOLAS 1974 and entered into force on 1 July 1999;
- .20 by the May 1998 amendments, which were adopted by resolution MSC.69(69) and entered into force on 1 July 2002;
- .21 by the May 1999 amendments, which were adopted by resolution MSC.87(71) and entered into force on 1 January 2001;
- .22 by the May 2000 amendments, which were adopted by resolution MSC.91(72) and entered into force on 1 January 2002;
- .23 by the November 2000 amendments, which were adopted by resolution MSC.99(73) and entered into force on 1 July 2002;
- .24 by the June 2001 amendments, which were adopted by resolution MSC.117(74) and entered into force on 1 January 2003;
- .25 by the May 2002 amendments, which were adopted by resolution MSC.123(75) and entered into force on 1 January 2004;
- .26 by the December 2002 amendments, which were adopted by resolution MSC.134(76) and entered into force on 1 July 2004;
- .27 by the December 2002 amendments, which were adopted by resolution 1 of the Conference of Contracting Governments to the International Convention for the Safety of Life at Sea, 1974 and entered into force on 1 July 2004;
- .28 by the June 2003 amendments, which were adopted by resolution MSC.142(77) and entered into force on 1 July 2006;
- .29 by the May 2004 amendments, which were adopted by resolutions MSC.151(78), MSC.152(78) and MSC.153(78), and entered into force on 1 January 2006, 1 July 2006 and 1 July 2006, respectively;
- .30 by the December 2004 amendments, which were adopted by resolution MSC.170(79) and entered into force on 1 July 2006;
- .31 by the May 2005 amendments, which were adopted by resolution MSC.194(80) and entered into force on 1 January 2007 (annex 1) and 1 January 2009 (annex 2);

- .32 by the May 2006 amendments, which were adopted by resolutions MSC.201(81) and MSC.202(81) and entered into force on 1 July 2010 and 1 January 2008, respectively;
 - .33 by the December 2006 amendments, which were adopted by resolution MSC.216(82) and entered into force on 1 July 2008 (annex 1), 1 January 2009 (annex 2), and 1 July 2010 (annex 3);
 - .34 by the October 2007 amendments, which were adopted by resolution MSC.239(83) and entered into force on 1 July 2009;
 - .35 by the May 2008 amendments, which were adopted by resolutions MSC.256(84) and MSC.257(84) and entered into force on 1 January 2010;
 - .36 by the December 2008 amendments, which were adopted by resolution MSC.269(85) and entered into force on 1 July 2010 (annex 1) and 1 January 2011 (annex 2);
 - .37 by the June 2009 amendments, which were adopted by resolution MSC.282(86) and entered into force on 1 January 2011;
 - .38 by the May 2010 amendments, which were adopted by resolutions MSC.290(87) and MSC.291(87) and entered into force on 1 January 2012;
 - .39 by the December 2010 amendments, which were adopted by resolution MSC.308(88) and entered into force on 1 July 2012;
 - .40 by the May 2011 amendments, which were adopted by resolution MSC.317(89) and entered into force on 1 January 2013;
 - .41 by the May 2012 amendments, which were adopted by resolution MSC.325(90) and entered into force on 1 January 2014;
 - .42 by the November 2012 amendments, which were adopted by resolution MSC.338(91) and entered into force on 1 July 2014;
 - .43 by the June 2013 amendments, which were adopted by resolution MSC.350(92) and entered into force on 1 January 2015;
 - .44 by the May 2014 amendments, which were adopted by resolutions MSC.365(93) and MSC.366(93) and entered into force on 1 January 2016;
 - .45 by the November 2014 amendments, which were adopted by resolutions MSC.380(94) and MSC.386(94) and entered into force on 1 July 2016 and on 1 January 2017, respectively;
 - .46 by the June 2015 amendments, which were adopted by resolutions MSC.392(95), MSC.394(95) and MSC.395(95) and entered into force on 1 January 2017;
 - .47 by the Secretariat corrections to resolution MSC.290(87) (see subparagraph .38 above) under the cover of Note Verbale NV.009;
 - .48 by the May 2016 amendments, which were adopted by resolution MSC.404(96) and entered into force on 1 January 2020;
 - .49 by the November 2016 amendments, which were adopted by resolution MSC.409(97) and entered into force on 1 January 2020;
 - .50 by the June 2017 amendments, which were adopted by resolution MSC.421(98) and entered into force on 1 January 2020; and
 - .51 by the May 2018 amendments, which were adopted by resolution MSC.436(99) and entered into force on 1 January 2020.
- 3 In addition to the above-mentioned amendments, the 1978 SOLAS Protocol has been amended, as follows:
- .1 by the 1981 amendments, which were adopted by resolution MSC.2(XLV) and entered into force on 1 September 1984;

- .2 by the 1988 amendments, which were adopted by resolution 1 of the Conference of Contracting Governments to SOLAS 1974 on the Global Maritime Distress and Safety System and entered into force on 1 February 1992; and
 - .3 by the 2012 amendments, which were adopted by resolution MSC.343(91) and entered into force on 1 July 2014.
- 4 The 1988 SOLAS Protocol has also been amended, as follows:
- .1 by the May 2000 amendments, which were adopted by resolution MSC.92(72) and entered into force on 1 January 2002;
 - .2 by the December 2000 amendments, which were adopted by resolution MSC.100(73) and entered into force on 1 July 2002;
 - .3 by the May 2002 amendments, which were adopted by resolution MSC.124(75) and entered into force on 1 January 2004;
 - .4 by the May 2004 amendments, which were adopted by resolution MSC.154(78) and entered into force on 1 July 2006;
 - .5 by the December 2004 amendments, which were adopted by resolution MSC.171(79) and entered into force on 1 July 2006;
 - .6 by the May 2006 amendments, which were adopted by resolution MSC.204(81) and shall be deemed to have been accepted on the date on which they are accepted by two thirds of the Parties to the Protocol and shall enter into force six months after that date;
 - .7 by the December 2006 amendments, which were adopted by resolution MSC.227(82) and entered into force on 1 July 2008;
 - .8 by the October 2007 amendments, which were adopted by resolution MSC.240(83) and entered into force on 1 July 2009;
 - .9 by the May 2008 amendments, which were adopted by resolution MSC.258(84) and entered into force on 1 January 2010;
 - .10 by the June 2009 amendments, which were adopted by resolution MSC.283(86) and entered into force on 1 January 2011;
 - .11 by the December 2010 amendments, which were adopted by resolution MSC.309(88) and entered into force on 1 July 2012; and
 - .12 by the November 2012 amendments, which were adopted by resolution MSC.344(91) and entered into force on 1 July 2014.

Content of the consolidated text

5 This publication, compiled by the Secretariat to provide an easy reference to SOLAS requirements, contains a consolidated text of the 1974 SOLAS Convention, the 1988 SOLAS Protocol, and all subsequent amendments thereto in force as on 1 January 2020.

6 In addition to the above, this publication contains the Unified Interpretations of SOLAS regulations, approved by IMO's Maritime Safety Committee (MSC) in order to facilitate global and consistent implementation of the requirements of the Convention. The Secretariat have compiled all Unified Interpretations approved by the MSC since 2011 (i.e. MSC 89). The Unified Interpretations are arranged by chapter and placed at the end of each chapter. They are also numbered by chapter and cross-referenced to the regulation they clarify.

- 7 The publication has been arranged in two parts:
- .1 part 1, which contains the 1974 SOLAS Convention and 1988 SOLAS Protocol articles, requirements and certificates; and

- .2 part 2, which contains a list of certificates and documents* to be carried on board ships and a list of resolutions adopted by the aforementioned SOLAS Conferences.

8 The operational requirements contained in this consolidated text are, in general, applicable to all ships, whilst the requirements for ship construction and equipment apply to ships constructed on or after the dates specified in the various regulations. To identify construction and equipment requirements applicable to ships constructed before 2020, previous texts of the 1974 SOLAS Convention, the 1988 SOLAS Protocol and the amendments to the Convention should be consulted.

9 Those requirements of chapter I and of the appendix to the annex to the 1974 SOLAS Convention which have been modified by the 1988 SOLAS Protocol are indicated by the symbol \square . No similar symbol is shown for requirements of the 1974 SOLAS Convention which were modified by the 1978 SOLAS Protocol because, whilst, in respect of chapter I of the Convention, the requirements thereof have been replaced and abrogated by the 1988 SOLAS Protocol, as between Parties to the Protocol, for requirements in other chapters of the Convention, they have been superseded by SOLAS amendments subsequently adopted.

10 In general, this publication reproduces the text of the 1974 SOLAS Convention and the 1988 SOLAS Protocol and includes the modifications and amendments thereto given in their authentic texts. In addition, it includes some minor editorial changes, which, while not altering the substance, aim at achieving a degree of consistency between the texts of the 1974 SOLAS Convention and the 1988 SOLAS Protocol and the various amendments. In particular:

- .1 while the decimal numbering system is used for paragraphs and subparagraphs of regulations in chapters II-1, II-2, III, IV, V, VI and VII, which were completely rewritten in the respective amendments, the original numbering system is retained in chapters I and VIII;
- .2 the references to regulations, paragraphs and chapters in the texts adopted in the 1981 and subsequent amendments use an abbreviated form (e.g. "regulation II-2/55.5"), whereas the original reference system is retained in unamended regulations (e.g. "regulation 5 of this chapter", "paragraph (a) of this regulation", etc.);
- .3 the term *tons gross tonnage* has been replaced by the term *gross tonnage* in view of the Assembly's decision (resolution A.493(XII)) that the term *tons gross tonnage* used in IMO instruments should be considered as having the same meaning as *gross tonnage* as determined under the 1969 Tonnage Convention; and
- .4 metric values of the SI system have been used in accordance with resolution A.351(IX).

Status of footnotes

11 Some of the footnotes contained in this publication are not part of the authentic text of the Convention. They were inserted or updated at the time of publication by the Secretariat, taking into account the provisions of the uniform wording for referencing IMO instruments (resolution A.911(22)). Footnotes inserted or updated refer to codes, guidelines, recommendations, explanatory notes or decisions of the MSC relating to a particular text. The reader must make use of the latest versions of the referenced texts, bearing in mind that such texts may have been revised or superseded by updated material since publication of this consolidated edition of the 1974 SOLAS Convention, as amended. However, this does not apply to footnotes containing references to specific editions of industry standards, such as their number or effective date, which should only be amended after approval of the relevant revised edition of the industry standard by the IMO.

* The list only includes the certificates and documents that are required under IMO instruments and it does not include certificates or documents required by other international organizations or governmental authorities. It should not be used in the context of port State control inspections for which convention requirements should be referred to.



Part 1

Articles of the International Convention for the Safety of Life at Sea, 1974

Articles of the International Convention for the Safety of Life at Sea, 1974

THE CONTRACTING GOVERNMENTS

BEING DESIROUS of promoting safety of life at sea by establishing in a common agreement uniform principles and rules directed thereto,

CONSIDERING that this end may best be achieved by the conclusion of a Convention to replace the International Convention for the Safety of Life at Sea, 1960, taking account of developments since that Convention was concluded,

HAVE AGREED as follows:

Article I

General obligations under the Convention

- (a) The Contracting Governments undertake to give effect to the provisions of the present Convention and the annex thereto, which shall constitute an integral part of the present Convention. Every reference to the present Convention constitutes at the same time a reference to the annex.
- (b) The Contracting Governments undertake to promulgate all laws, decrees, orders and regulations and to take all other steps which may be necessary to give the present Convention full and complete effect, so as to ensure that, from the point of view of safety of life, a ship is fit for the service for which it is intended.

Article II

*Application**

The present Convention shall apply to ships entitled to fly the flag of States the Governments of which are Contracting Governments.

Article III

Laws, regulations[†]

The Contracting Governments undertake to communicate to and deposit with the Secretary-General of the Inter-Governmental Maritime Consultative Organization[‡] (hereinafter referred to as "the Organization"):

- (a) a list of non-governmental agencies which are authorized to act in their behalf in the administration of measures for safety of life at sea for circulation to the Contracting Governments for the information of their officers;

* Refer to *Transfer of ships between States* (MSC/Circ.1140-MEPC/Circ.424).

[†] Refer to Article III of the 1988 SOLAS Protocol; *Notification and circulation through the Global Integrated Shipping Information System (GISIS)* (resolution A.1074(28)).

[‡] The name of the Organization was changed to "International Maritime Organization" (IMO) by virtue of amendments to the Organization's Convention which entered into force on 22 May 1982.

(b) the text of laws, decrees, orders and regulations which shall have been promulgated on the various matters within the scope of the present Convention;

(c) a sufficient number of specimens of their certificates issued under the provisions of the present Convention for circulation to the Contracting Governments for the information of their officers.

Article IV

Cases of force majeure

(a) A ship, which is not subject to the provisions of the present Convention at the time of its departure on any voyage, shall not become subject to the provisions of the present Convention on account of any deviation from its intended voyage due to stress of weather or any other case of force majeure.

(b) Persons who are on board a ship by reason of force majeure or in consequence of the obligation laid upon the master to carry shipwrecked or other persons shall not be taken into account for the purpose of ascertaining the application to a ship of any provisions of the present Convention.

Article V

Carriage of persons in emergencies

(a) For the purpose of evacuating persons in order to avoid a threat to the security of their lives a Contracting Government may permit the carriage of a larger number of persons in its ships than is otherwise permissible under the present Convention.

(b) Such permission shall not deprive other Contracting Governments of any right of control under the present Convention over such ships which come within their ports.

(c) Notice of any such permission, together with a statement of the circumstances, shall be sent to the Secretary-General of the Organization by the Contracting Government granting such permission.

Article VI

Prior treaties and conventions

(a) As between the Contracting Governments, the present Convention replaces and abrogates the International Convention for the Safety of Life at Sea which was signed in London on 17 June 1960.

(b) All other treaties, conventions and arrangements relating to safety of life at sea, or matters appertaining thereto, at present in force between Governments parties to the present Convention shall continue to have full and complete effect during the terms thereof as regards:

(i) ships to which the present Convention does not apply;

(ii) ships to which the present Convention applies, in respect of matters for which it has not expressly provided.

(c) To the extent, however, that such treaties, conventions or arrangements conflict with the provisions of the present Convention, the provisions of the present Convention shall prevail.

(d) All matters which are not expressly provided for in the present Convention remain subject to the legislation of the Contracting Governments.

Article VII

Special rules drawn up by agreement

When in accordance with the present Convention special rules are drawn up by agreement between all or some of the Contracting Governments, such rules shall be communicated to the Secretary-General of the Organization for circulation to all Contracting Governments.

Article VIII

*Amendments**

- (a) The present Convention may be amended by either of the procedures specified in the following paragraphs.
- (b) Amendments after consideration within the Organization:
- (i) Any amendment proposed by a Contracting Government shall be submitted to the Secretary-General of the Organization, who shall then circulate it to all Members of the Organization and all Contracting Governments at least six months prior to its consideration.
 - (ii) Any amendment proposed and circulated as above shall be referred to the Maritime Safety Committee of the Organization for consideration.
 - (iii) Contracting Governments of States, whether or not Members of the Organization, shall be entitled to participate in the proceedings of the Maritime Safety Committee for the consideration and adoption of amendments.
 - (iv) Amendments shall be adopted by a two-thirds majority of the Contracting Governments present and voting in the Maritime Safety Committee expanded as provided for in subparagraph (iii) of this paragraph (hereinafter referred to as "the expanded Maritime Safety Committee") on condition that at least one third of the Contracting Governments shall be present at the time of voting.
 - (v) Amendments adopted in accordance with subparagraph (iv) of this paragraph shall be communicated by the Secretary-General of the Organization to all Contracting Governments for acceptance.
 - (vi) (1) An amendment to an article of the Convention or to chapter I of the annex shall be deemed to have been accepted on the date on which it is accepted by two thirds of the Contracting Governments.
(2) An amendment to the annex other than chapter I shall be deemed to have been accepted
 - (aa) at the end of two years from the date on which it is communicated to Contracting Governments for acceptance; or
 - (bb) at the end of a different period, which shall not be less than one year, if so determined at the time of its adoption by a two-thirds majority of the Contracting Governments present and voting in the expanded Maritime Safety Committee.However, if within the specified period either more than one third of Contracting Governments, or Contracting Governments the combined merchant fleets of which constitute not less than 50% of the gross tonnage of the world's merchant fleet, notify the Secretary-General of the Organization that they object to the amendment, it shall be deemed not to have been accepted.
 - (vii) (1) An amendment to an article of the Convention or to chapter I of the annex shall enter into force with respect to those Contracting Governments which have accepted it, six months after the date on which it is deemed to have been accepted, and with respect to each Contracting Government which accepts it after that date, six months after the date of that Contracting Government's acceptance.

* Refer to *Guidance on entry into force of amendments to the 1974 SOLAS Convention and related mandatory instruments* (MSC.1/Circ.1481) and *Guidance on drafting of amendments to the 1974 SOLAS Convention and related mandatory instruments* (MSC.1/Circ.1500/Rev.1).

- (2) An amendment to the annex other than chapter I shall enter into force with respect to all Contracting Governments, except those which have objected to the amendment under subparagraph (vi)(2) of this paragraph and which have not withdrawn such objections, 6 months after the date on which it is deemed to have been accepted. However, before the date set for entry into force, any Contracting Government may give notice to the Secretary-General of the Organization that it exempts itself from giving effect to that amendment for a period not longer than one year from the date of its entry into force, or for such longer period as may be determined by a two-thirds majority of the Contracting Governments present and voting in the expanded Maritime Safety Committee at the time of the adoption of the amendment.
- (c) Amendment by a Conference:
- (i) Upon the request of a Contracting Government concurred in by at least one third of the Contracting Governments, the Organization shall convene a Conference of Contracting Governments to consider amendments to the present Convention.
 - (ii) Every amendment adopted by such a Conference by a two-thirds majority of the Contracting Governments present and voting shall be communicated by the Secretary-General of the Organization to all Contracting Governments for acceptance.
 - (iii) Unless the Conference decides otherwise, the amendment shall be deemed to have been accepted and shall enter into force in accordance with the procedures specified in subparagraphs (b)(vi) and (b)(vii) respectively of this article, provided that references in these paragraphs to the expanded Maritime Safety Committee shall be taken to mean references to the Conference.
- (d)
- (i) A Contracting Government which has accepted an amendment to the annex which has entered into force shall not be obliged to extend the benefit of the present Convention in respect of the certificates issued to a ship entitled to fly the flag of a State the Government of which, pursuant to the provisions of subparagraph (b)(vi)(2) of this article, has objected to the amendment and has not withdrawn such an objection, but only to the extent that such certificates relate to matters covered by the amendment in question.
 - (ii) A Contracting Government which has accepted an amendment to the annex which has entered into force shall extend the benefit of the present Convention in respect of the certificates issued to a ship entitled to fly the flag of a State the Government of which, pursuant to the provisions of subparagraph (b)(vii)(2) of this article, has notified the Secretary-General of the Organization that it exempts itself from giving effect to the amendment.
- (e) Unless expressly provided otherwise, any amendment to the present Convention made under this article, which relates to the structure of a ship, shall apply only to ships the keels of which are laid or which are at a similar stage of construction, on or after the date on which the amendment enters into force.
- (f) Any declaration of acceptance of, or objection to, an amendment or any notice given under subparagraph (b)(vii)(2) of this article shall be submitted in writing to the Secretary-General of the Organization, who shall inform all Contracting Governments of any such submission and the date of its receipt.
- (g) The Secretary-General of the Organization shall inform all Contracting Governments of any amendments which enter into force under this article, together with the date on which each such amendment enters into force.

Article IX

Signature, ratification, acceptance, approval and accession

- (a) The present Convention shall remain open for signature at the Headquarters of the Organization from 1 November 1974 until 1 July 1975 and shall thereafter remain open for accession. States may become parties to the present Convention by:
- (i) signature without reservation as to ratification, acceptance or approval; or

- (ii) signature subject to ratification, acceptance or approval, followed by ratification, acceptance or approval; or
- (iii) accession.

(b) Ratification, acceptance, approval or accession shall be effected by the deposit of an instrument to that effect with the Secretary-General of the Organization.

(c) The Secretary-General of the Organization shall inform the Governments of all States which have signed the present Convention or acceded to it of any signature or of the deposit of any instrument of ratification, acceptance, approval or accession and the date of its deposit.

Article X

Entry into force

(a) The present Convention shall enter into force 12 months after the date on which not less than 25 States, the combined merchant fleets of which constitute not less than 50% of the gross tonnage of the world's merchant shipping, have become parties to it in accordance with article IX.

(b) Any instrument of ratification, acceptance, approval or accession deposited after the date on which the present Convention enters into force shall take effect three months after the date of deposit.

(c) After the date on which an amendment to the present Convention is deemed to have been accepted under article VIII, any instrument of ratification, acceptance, approval or accession deposited shall apply to the Convention as amended.

Article XI

Denunciation

(a) The present Convention may be denounced by any Contracting Government at any time after the expiry of five years from the date on which the Convention enters into force for that Government.

(b) Denunciation shall be effected by the deposit of an instrument of denunciation with the Secretary-General of the Organization who shall notify all the other Contracting Governments of any instrument of denunciation received and of the date of its receipt as well as the date on which such denunciation takes effect.

(c) A denunciation shall take effect one year, or such longer period as may be specified in the instrument of denunciation, after its receipt by the Secretary-General of the Organization.

Article XII

Deposit and registration

(a) The present Convention shall be deposited with the Secretary-General of the Organization who shall transmit certified true copies thereof to the Governments of all States which have signed the present Convention or acceded to it.

(b) As soon as the present Convention enters into force, the text shall be transmitted by the Secretary-General of the Organization to the Secretary-General of the United Nations for registration and publication, in accordance with Article 102 of the Charter of the United Nations.

Article XIII

Languages

The present Convention is established in a single copy in the Chinese, English, French, Russian and Spanish languages, each text being equally authentic. Official translations in the Arabic, German and Italian languages shall be prepared and deposited with the signed original.

IN WITNESS WHEREOF the undersigned,* being duly authorized by their respective Governments for that purpose, have signed the present Convention.

DONE AT LONDON this first day of November one thousand nine hundred and seventy-four.

* Signatures omitted.

Protocol of 1988 relating
to the International
Convention for the Safety
of Life at Sea, 1974

Protocol of 1988 relating to the International Convention for the Safety of Life at Sea, 1974

THE PARTIES TO THE PRESENT PROTOCOL,

BEING PARTIES to the International Convention for the Safety of Life at Sea, done at London on 1 November 1974,

RECOGNIZING the need for the introduction into the above-mentioned Convention of provisions for survey and certification harmonized with corresponding provisions in other international instruments,

CONSIDERING that this need may best be met by the conclusion of a Protocol relating to the International Convention for the Safety of Life at Sea, 1974,

HAVE AGREED as follows:

Article I

General obligations

- 1 The Parties to the present Protocol undertake to give effect to the provisions of the present Protocol and the annex hereto, which shall constitute an integral part of the present Protocol. Every reference to the present Protocol constitutes at the same time a reference to the annex hereto.
- 2 As between the Parties to the present Protocol, the provisions of the International Convention for the Safety of Life at Sea, 1974, as amended, (hereinafter referred to as "the Convention") shall apply subject to the modifications and additions set out in the present Protocol.
- 3 With respect to ships entitled to fly the flag of a State which is not a Party to the Convention and the present Protocol, the Parties to the present Protocol shall apply the requirements of the Convention and the present Protocol as may be necessary to ensure that no more favourable treatment is given to such ships.

Article II

Prior treaties

- 1 As between the Parties to the present Protocol, the present Protocol replaces and abrogates the Protocol of 1978 relating to the Convention.
- 2 Notwithstanding any other provisions of the present Protocol, any certificate issued under, and in accordance with, the provisions of the Convention and any supplement to such certificate issued under, and in accordance with, the provisions of the Protocol of 1978 relating to the Convention which is current when the present Protocol enters into force in respect of the Party by which the certificate or supplement was issued, shall remain valid until it expires under the terms of the Convention or the Protocol of 1978 relating to the Convention, as the case may be.
- 3 A Party to the present Protocol shall not issue certificates under, and in accordance with, the provisions of the International Convention for the Safety of Life at Sea, 1974, as adopted on 1 November 1974.

Article III

*Communication of information**

The Parties to the present Protocol undertake to communicate to, and deposit with, the Secretary-General of the International Maritime Organization (hereinafter referred to as "the Organization"):

- (a) the text of laws, decrees, orders and regulations and other instruments which have been promulgated on the various matters within the scope of the present Protocol;
- (b) a list of nominated surveyors or recognized organizations which are authorized to act on their behalf in the administration of measures for safety of life at sea for circulation to the Parties for information of their officers, and a notification of the specific responsibilities and conditions of the authority delegated to those nominated surveyors or recognized organizations; and
- (c) a sufficient number of specimens of their certificates issued under the provision of the present Protocol.

Article IV

Signature, ratification, acceptance, approval and accession

1 The present Protocol shall be open for signature at the Headquarters of the Organization from 1 March 1989 to 28 February 1990 and shall thereafter remain open for accession. Subject to the provisions of paragraph 3, States may express their consent to be bound by the present Protocol by:

- (a) signature without reservation as to ratification, acceptance or approval; or
- (b) signature subject to ratification, acceptance or approval, followed by ratification, acceptance or approval; or
- (c) accession.

2 Ratification, acceptance, approval or accession shall be effected by the deposit of an instrument to that effect with the Secretary-General of the Organization.

3 The present Protocol may be signed without reservation, ratified, accepted, approved or acceded to only by States which have signed without reservation, ratified, accepted, approved or acceded to the Convention.

Article V

Entry into force

1 The present Protocol shall enter into force twelve months after the date on which both the following conditions have been met:

- (a) not less than fifteen States, the combined merchant fleets of which constitute not less than 50% of the gross tonnage of the world's merchant shipping, have expressed their consent to be bound by it in accordance with article IV, and
- (b) the conditions for the entry into force of the Protocol of 1988 relating to the International Convention on Load Lines, 1966, have been met,

provided that the present Protocol shall not enter into force before 1 February 1992.

2 For States which have deposited an instrument of ratification, acceptance, approval or accession in respect of the present Protocol after the conditions for entry into force thereof have been met but prior to the date of entry into force, the ratification, acceptance, approval or accession shall take effect on the date of entry into force of the present Protocol or three months after the date of deposit of the instrument, whichever is the later date.

* Refer to *Notification and circulation through the Global Integrated Shipping Information System (GISIS)* (resolution A.1074(28)).

3 Any instrument of ratification, acceptance, approval or accession deposited after the date on which the present Protocol enters into force shall take effect three months after the date of deposit.

4 After the date on which an amendment to the present Protocol is deemed to have been accepted under article VI, any instrument of ratification, acceptance, approval or accession deposited shall apply to the present Protocol as amended.

Article VI *Amendments**

The procedures set out in article VIII of the Convention shall apply to amendments to the present Protocol, provided that:

- (a) references in that article to the Convention and to Contracting Governments shall be taken to mean references to the present Protocol and to the Parties to the present Protocol respectively;
- (b) amendments to the articles of the present Protocol and to the annex thereto shall be adopted and brought into force in accordance with the procedure applicable to amendments to the articles of the Convention or to chapter I of the annex thereto; and
- (c) amendments to the appendix to the annex to the present Protocol may be adopted and brought into force in accordance with the procedure applicable to amendments to the annex to the Convention other than chapter I.

Article VII *Denunciation*

1 The present Protocol may be denounced by any Party at any time after the expiry of five years from the date on which the present Protocol enters into force for that Party.

2 Denunciation shall be effected by the deposit of an instrument of denunciation with the Secretary-General of the Organization.

3 A denunciation shall take effect one year, or such longer period as may be specified in the instrument of denunciation, after its receipt by the Secretary-General of the Organization.

4 A denunciation of the Convention by a Party shall be deemed to be a denunciation of the present Protocol by that Party. Such denunciation shall take effect on the same date as denunciation of the Convention takes effect according to paragraph (c) of article XI of the Convention.

Article VIII *Depositary*

1 The present Protocol shall be deposited with the Secretary-General of the Organization (hereinafter referred to as "the depositary").

2 The depositary shall:

- (a) inform the Governments of all States which have signed the present Protocol or acceded thereto of:
 - (i) each new signature or deposit of an instrument of ratification, acceptance, approval or accession, together with the date thereof;

* Refer to *Guidance on entry into force of amendments to the 1974 SOLAS Convention and related mandatory instruments* (MSC.1/Circ.1481) and *Interim guidance on drafting of amendments to the 1974 SOLAS Convention and related mandatory instruments* (MSC.1/Circ.1483).

- (ii) the date of entry into force of the present Protocol;
 - (iii) the deposit of any instrument of denunciation of the present Protocol together with the date on which it was received and the date on which the denunciation takes effect;
- (b) transmit certified true copies of the present Protocol to the Governments of all States which have signed the present Protocol or acceded thereto.

3 As soon as the present Protocol enters into force, a certified true copy thereof shall be transmitted by the depositary to the Secretariat of the United Nations for registration and publication in accordance with Article 102 of the Charter of the United Nations.

Article IX

Languages

The present Protocol is established in a single original in the Arabic, Chinese, English, French, Russian and Spanish languages, each text being equally authentic. An official translation into the Italian language shall be prepared and deposited with the signed original.

DONE AT LONDON this eleventh day of November one thousand nine hundred and eighty-eight.

IN WITNESS WHEREOF the undersigned,* being duly authorized by their respective Governments for that purpose, have signed the present Protocol.

* Signatures omitted.













Consolidated text of the
annex to the 1974 SOLAS
Convention and the 1988
Protocol relating thereto

Chapter I

General provisions

Chapter I

General provisions

Part A	Application, definitions, etc.	
Regulation 1	Application	23
Regulation 2	Definitions	23
Regulation 3	Exceptions	24
Regulation 4	Exemptions	24
Regulation 5	Equivalents	24
Part B	Surveys and certificates	
 Regulation 6	Inspection and survey	25
 Regulation 7	Surveys of passenger ships	26
 Regulation 8	Surveys of life-saving appliances and other equipment of cargo ships	27
 Regulation 9	Surveys of radio installations of cargo ships	28
 Regulation 10	Surveys of structure, machinery and equipment of cargo ships	28
 Regulation 11	Maintenance of conditions after survey	29
 Regulation 12	Issue or endorsement of certificates	30
 Regulation 13	Issue or endorsement of certificates by another Government	30
 Regulation 14	Duration and validity of certificates	31
 Regulation 15	Forms of certificates and records of equipment	32
 Regulation 16	Availability of certificates	33
Regulation 17	Acceptance of certificates	33
Regulation 18	Qualification of certificates	33
 Regulation 19	Control	33
Regulation 20	Privileges	34
Part C	Casualties	
Regulation 21	Casualties	35

Part A

Application, definitions, etc.

Regulation 1 *Application**

- (a) Unless expressly provided otherwise, the present regulations apply only to ships engaged on international voyages.
- (b) The classes of ships to which each chapter applies are more precisely defined, and the extent of the application is shown, in each chapter.

Regulation 2 *Definitions*

For the purpose of the present regulations, unless expressly provided otherwise:

- (a) *Regulations* means the regulations contained in the annex to the present Convention.
- (b) *Administration* means the Government of the State whose flag the ship is entitled to fly.
- (c) *Approved* means approved by the Administration.
- (d) *International voyage* means a voyage from a country to which the present Convention applies to a port outside such country, or conversely.
- (e) A *passenger* is every person other than:
 - (i) the master and the members of the crew or other persons employed or engaged in any capacity on board a ship on the business of that ship; and
 - (ii) a child under one year of age.
- (f) A *passenger ship* is a ship which carries more than twelve passengers.
- (g) A *cargo ship* is any ship which is not a passenger ship.
- (h) A *tanker* is a cargo ship constructed or adapted for the carriage in bulk of liquid cargoes of an inflammable[†] nature.
- (i) A *fishing vessel* is a vessel used for catching fish, whales, seals, walrus or other living resources of the sea.
- (j) A *nuclear ship* is a ship provided with a nuclear power plant.
- P88** (k) *New ship* means a ship the keel of which is laid or which is at a similar stage of construction on or after 25 May 1980.
- (l) *Existing ship* means a ship which is not a new ship.
- (m) A *mile* is 1,852 metres or 6,080 feet.
- P88** (n) *Anniversary date* means the day and the month of each year which will correspond to the date of expiry of the relevant certificate.

* For some specific type of ships, refer to other IMO instruments, such as the *Code of safety for special purpose ships, 2008* (resolution MSC.266(84)), as amended (2008 SPS Code); the *Code for the construction and equipment of mobile offshore drilling unit, 2009* (resolution A.1023(26)), as amended (2009 MODU Code); the *Code for the transport and handling of hazardous and noxious liquid substances in bulk on offshore support vessels* (resolution A.1122(30)) (OSV Chemical Code); the *Code of safety for diving systems, 1995* (resolution A.831(19)) (Diving Code, 1995) and so on.

[†] "Inflammable" has the same meaning as "flammable".

Regulation 3

Exceptions

- (a) The present regulations, unless expressly provided otherwise, do not apply to:
- (i) Ships of war and troopships.
 - (ii) Cargo ships of less than 500 gross tonnage.
 - (iii) Ships not propelled by mechanical means.
 - (iv) Wooden ships of primitive build.
 - (v) Pleasure yachts not engaged in trade.
 - (vi) Fishing vessels.
- (b) Except as expressly provided in chapter V, nothing herein shall apply to ships solely navigating the Great Lakes of North America and the River St Lawrence as far east as a straight line drawn from Cap des Rosiers to West Point, Anticosti Island and, on the north side of Anticosti Island, the 63rd meridian.

Regulation 4

Exemptions*

- (a) A ship which is not normally engaged on international voyages but which, in exceptional circumstances, is required to undertake a single international voyage may be exempted by the Administration from any of the requirements of the present regulations provided that it complies with safety requirements which are adequate in the opinion of the Administration for the voyage which is to be undertaken by the ship.
- (b) The Administration may exempt any ship which embodies features of a novel kind from any of the provisions of chapters II-1, II-2, III and IV of these regulations the application of which might seriously impede research into the development of such features and their incorporation in ships engaged on international voyages. Any such ship shall, however, comply with safety requirements which, in the opinion of that Administration, are adequate for the service for which it is intended and are such as to ensure the overall safety of the ship and which are acceptable to the Governments of the States to be visited by the ship. The Administration which allows any such exemption shall communicate to the Organization particulars of same and the reasons therefor which the Organization shall circulate to the Contracting Governments for their information.

Regulation 5

Equivalents†

- (a) Where the present regulations require that a particular fitting, material, appliance or apparatus, or type thereof, shall be fitted or carried in a ship, or that any particular provision shall be made, the Administration may allow any other fitting, material, appliance or apparatus, or type thereof, to be fitted or carried, or any other provision to be made in that ship, if it is satisfied by trial thereof or otherwise that such fitting, material, appliance or apparatus, or type thereof, or provision, is at least as effective as that required by the present regulations.
- (b) Any Administration which so allows, in substitution, a fitting, material, appliance or apparatus, or type thereof, or provision, shall communicate to the Organization particulars thereof together with a report on any trials made and the Organization shall circulate such particulars to other Contracting Governments for the information of their officers.

* Refer to *Issue of Exemption Certificates under the 1974 SOLAS Convention and Amendments thereto*, as amended (SLS.14/Circ.115); *Port State concurrence with SOLAS exemptions* (MSC/Circ.606) and *Notification and circulation through the Global Integrated Shipping Information System (GISIS)* (resolution A.1074(28)).

† Refer to *Guidelines for the approval of alternatives and equivalents as provided for in various IMO instruments* (MSC.1/Circ.1455) and *Notification and circulation through the Global Integrated Shipping Information System (GISIS)* (resolution A.1074(28)).

Part B

Surveys and certificates*

P88 Regulation 6

Inspection and survey

(a) The inspection and survey of ships, so far as regards the enforcement of the provisions of the present regulations and the granting of exemptions therefrom, shall be carried out by officers of the Administration. The Administration may, however, entrust the inspections and surveys either to surveyors nominated for the purpose or to organizations recognized by it.

(b) An Administration nominating surveyors or recognizing organizations to conduct inspections and surveys as set forth in paragraph (a) shall as a minimum empower any nominated surveyor or recognized organization to:

- (i) require repairs to a ship;
- (ii) carry out inspections and surveys if requested by the appropriate authorities of a port State.

The Administration shall notify the Organization of the specific responsibilities and conditions of the authority delegated to nominated surveyors or recognized organizations.†

(c) When a nominated surveyor or recognized organization determines that the condition of the ship or its equipment does not correspond substantially with the particulars of the certificate or is such that the ship is not fit to proceed to sea without danger to the ship, or persons on board, such surveyor or organization shall immediately ensure that corrective action is taken and shall in due course notify the Administration. If such corrective action is not taken the relevant certificate should be withdrawn and the Administration shall be notified immediately; and, if the ship is in the port of another Party, the appropriate authorities of the port State shall also be notified immediately. When an officer of the Administration, a nominated surveyor or a recognized organization has notified the appropriate authorities of the port State, the Government of the port State concerned shall give such officer, surveyor or organization any necessary assistance to carry out their obligations under this regulation. When applicable, the Government of the port State concerned shall ensure that the ship shall not sail until it can proceed to sea, or leave port for the purpose of proceeding to the appropriate repair yard, without danger to the ship or persons on board.

(d) In every case, the Administration shall fully guarantee the completeness and efficiency of the inspection and survey, and shall undertake to ensure the necessary arrangements to satisfy this obligation.

* Refer to *Global and uniform implementation of the harmonized system of survey and certification (HSSC)* (resolution A.883(21)), *Survey Guidelines under the Harmonized System of Survey and Certification (HSSC), 2019* (resolution A.1140(31), as may be amended), *Guidelines for pre-planning of surveys in dry dock of ships which are not subject to the enhanced programme of inspections* (MSC.1/Circ.1223), *Unified interpretation of the term "first survey" referred to in SOLAS regulations* (MSC.1/Circ.1290) and *Guidelines for Administrations to ensure the adequacy of transfer of class-related matters between recognized organizations (ROs)* (MSC-MEPC.5/Circ.2).

† Refer to the *Code for Recognized Organizations (RO Code)* (MSC.349(92) and MEPC.237(65)); *Communication of information on the authorization of recognized organizations (ROs)* (MSC/Circ.1010-MEPC/Circ.382) and *Notification and circulation through the Global Integrated Shipping Information System (GISIS)* (resolution A.1074(28)).

P88 Regulation 7

Surveys of passenger ships*

- (a) A passenger ship shall be subject to the surveys specified below:
- (i) an initial survey before the ship is put in service;
 - (ii) a renewal survey once every 12 months, except where regulation 14(b), (e), (f) and (g) is applicable;
 - (iii) additional surveys, as occasion arises.
- (b) The surveys referred to above shall be carried out as follows:
- (i) the initial survey shall include a complete inspection of the ship's structure, machinery and equipment, including the outside of the ship's bottom and the inside and outside of the boilers. This survey shall be such as to ensure that the arrangements, materials and scantlings of the structure, boilers and other pressure vessels and their appurtenances, main and auxiliary machinery, electrical installation, radio installations including those used in life-saving appliances, fire protection, fire safety systems and appliances, life-saving appliances and arrangements, shipborne navigational equipment, nautical publications, means of embarkation for pilots and other equipment fully comply with the requirements of the present regulations, and of the laws, decrees, orders and regulations promulgated as a result thereof by the Administration for ships of the service for which it is intended. The survey shall also be such as to ensure that the workmanship of all parts of the ship and its equipment is in all respects satisfactory, and that the ship is provided with the lights, shapes, means of making sound signals and distress signals as required by the provisions of the present regulations and the International Regulations for Preventing Collisions at Sea in force;
 - (ii) the renewal survey shall include an inspection of the structure, boilers and other pressure vessels, machinery and equipment, including the outside of the ship's bottom. The survey shall be such as to ensure that the ship, as regards the structure, boilers and other pressure vessels and their appurtenances, main and auxiliary machinery, electrical installation, radio installations including those used in life-saving appliances, fire protection, fire safety systems and appliances, life-saving appliances and arrangements, shipborne navigational equipment, nautical publications, means of embarkation for pilots and other equipment is in satisfactory condition and is fit for the service for which it is intended, and that it complies with the requirements of the present regulations and of the laws, decrees, orders and regulations promulgated as a result thereof by the Administration. The lights, shapes, means of making sound signals and distress signals carried by the ship shall also be subject to the above-mentioned survey for the purpose of ensuring that they comply with the requirements of the present regulations and of the International Regulations for Preventing Collisions at Sea in force;
 - (iii) an additional survey either general or partial, according to the circumstances, shall be made after a repair resulting from investigations prescribed in regulation 11, or whenever any important repairs or renewals are made. The survey shall be such as to ensure that the necessary repairs or renewals have been effectively made, that the material and workmanship of such repairs or renewals are in all respects satisfactory, and that the ship complies in all respects with the provisions of the present regulations and of the International Regulations for Preventing Collisions at Sea in force, and of the laws, decrees, orders and regulations promulgated as a result thereof by the Administration.
- (c) (i) the laws, decrees, orders and regulations referred to in paragraph (b) of this regulation shall be in all respects such as to ensure that, from the point of view of safety of life, the ship is fit for the service for which it is intended;
- (ii) they shall among other things prescribe the requirements to be observed as to the initial and subsequent hydraulic or other acceptable alternative tests to which the main and auxiliary boilers,

* Refer to *Surveys and inspections of ro-ro passenger ships* (resolution A.794(19)), *Guidelines for unscheduled inspections of ro-ro passenger ships by flag States* (MSC/Circ.956) and *Guidelines for the assessment of technical provisions for the performance of an in-water survey in lieu of bottom inspection in dry-dock to permit one dry-dock examination in any five-year period for passenger ships other than ro-ro passenger ships* (MSC.1/Circ.1348).

connections, steam pipes, high pressure receivers and fuel tanks for internal combustion engines are to be submitted including the test procedures to be followed and the intervals between two consecutive tests.

Regulation 8

*Surveys of life-saving appliances and other equipment of cargo ships**

- (a) The life-saving appliances and other equipment of cargo ships of 500 gross tonnage and upwards as referred to in paragraph (b)(i) shall be subject to the surveys specified below:
- (i) an initial survey before the ship is put in service;
 - (ii) a renewal survey at intervals specified by the Administration but not exceeding 5 years, except where regulation 14(b), (e), (f) and (g) is applicable;
 - (iii) a periodical survey within three months before or after the second anniversary date or within three months before or after the third anniversary date of the Cargo Ship Safety Equipment Certificate which shall take the place of one of the annual surveys specified in paragraph (a)(iv);
 - (iv) an annual survey within 3 months before or after each anniversary date of the Cargo Ship Safety Equipment Certificate;
 - (v) an additional survey as prescribed for passenger ships in regulation 7(b)(iii).
- (b) The surveys referred to in paragraph (a) shall be carried out as follows:
- (i) the initial survey shall include a complete inspection of the fire safety systems and appliances, life-saving appliances and arrangements except radio installations, the shipborne navigational equipment, means of embarkation for pilots and other equipment to which chapters II-1, II-2, III and V apply to ensure that they comply with the requirements of the present regulations, are in satisfactory condition and are fit for the service for which the ship is intended. The fire control plans, nautical publications, lights, shapes, means of making sound signals and distress signals shall also be subject to the above-mentioned survey for the purpose of ensuring that they comply with the requirements of the present regulations and, where applicable, the International Regulations for Preventing Collisions at Sea in force;
 - (ii) the renewal and periodical surveys shall include an inspection of the equipment referred to in paragraph (b)(i) to ensure that it complies with the relevant requirements of the present regulations and the International Regulations for Preventing Collisions at Sea in force, is in satisfactory condition and is fit for the service for which the ship is intended;
 - (iii) the annual survey shall include a general inspection of the equipment referred to in paragraph (b)(i) to ensure that it has been maintained in accordance with regulation 11(a) and that it remains satisfactory for the service for which the ship is intended.
- (c) The periodical and annual surveys referred to in paragraphs (a)(iii) and (a)(iv) shall be endorsed on the Cargo Ship Safety Equipment Certificate.

* Refer to *Guidelines for construction, installation, maintenance and inspection/survey of means of embarkation and disembarkation* (MSC.1/Circ.1331); *Servicing of life-saving appliances and radiocommunication equipment under the Harmonized System of Survey and Certification (HSSC)* (MSC/Circ.955); *Guidelines for the performance and testing criteria and surveys of high-expansion foam concentrates for fixed-extinguishing systems* (MSC/Circ.670); *Guidelines for performance and testing criteria and surveys of medium expansion from concentrates for fixed fire-extinguishing systems* (MSC/Circ.798) and *Guidance on the survey and certification of compliance of ships with the requirement to transmit LRIT Information* (MSC.1/Circ.1307).

Regulation 9*Surveys of radio installations of cargo ships**

- (a) The radio installations, including those used in life-saving appliances, of cargo ships to which chapters III and IV apply shall be subject to the surveys specified below:
- (i) an initial survey before the ship is put in service;
 - (ii) a renewal survey at intervals specified by the Administration but not exceeding five years, except where regulation 14(b), (e), (f) and (g) is applicable;
 - (iii) a periodical survey within three months before or after each anniversary date of the Cargo Ship Safety Radio Certificate;
 - (iv) an additional survey as prescribed for passenger ships in regulation 7(b)(iii).
- (b) The surveys referred to in paragraph (a) shall be carried out as follows:
- (i) the initial survey shall include a complete inspection of the radio installations of cargo ships, including those used in life-saving appliances, to ensure that they comply with the requirements of the present regulations;
 - (ii) the renewal and periodical surveys shall include an inspection of the radio installations of cargo ships, including those used in life-saving appliances, to ensure that they comply with the requirements of the present regulations.
- (c) The periodical surveys referred to in paragraph (a)(iii) shall be endorsed on the Cargo Ship Safety Radio Certificate.

Regulation 10*Surveys of structure, machinery and equipment of cargo ships†*

- (a) The structure, machinery and equipment (other than items in respect of which a Cargo Ship Safety Equipment Certificate and a Cargo Ship Safety Radio Certificate are issued) of a cargo ship as referred to in paragraph (b)(i) shall be subject to the surveys and inspections specified below:
- (i) an initial survey including an inspection of the outside of the ship's bottom before the ship is put in service;
 - (ii) a renewal survey at intervals specified by the Administration but not exceeding 5 years, except where regulation 14(b), (e), (f) and (g) is applicable;
 - (iii) an intermediate survey within three months before or after the second anniversary date or within three months before or after the third anniversary date of the Cargo Ship Safety Construction Certificate, which shall take the place of one of the annual surveys specified in paragraph (a)(iv);
 - (iv) an annual survey within 3 months before or after each anniversary date of the Cargo Ship Safety Construction Certificate;
 - (v) a minimum of two inspections of the outside of the ship's bottom during any five-year period, except where regulation 14(e) or (f) is applicable. Where regulation 14(e) or (f) is applicable, this five-year period may be extended to coincide with the extended period of validity of the certificate. In all cases the interval between any two such inspections shall not exceed 36 months;
 - (vi) an additional survey as prescribed for passenger ships in regulation 7(b)(iii).

* Refer to *Servicing of life-saving appliances and radiocommunication equipment under the Harmonized System of Survey and Certification* (HSSC) (MSC/Circ.955).

† Refer to *Guidance for planning the enhanced programme of inspections during surveys of bulk carriers and oil tankers* (MSC/Circ.655); *Guidelines for pre-planning of surveys in dry-dock of ships which are not subject to the Enhanced programme of inspections* (MSC.1/Circ.1223) and *Guidelines for bulk carrier hatch cover surveys and owner's inspections and maintenance* (MSC/Circ.1071).

- (b) The surveys and inspections referred to in paragraph (a) shall be carried out as follows:
- (i) the initial survey shall include a complete inspection of the structure, machinery and equipment. This survey shall be such as to ensure that the arrangements, materials, scantlings and workmanship of the structure, boilers and other pressure vessels, their appurtenances, main and auxiliary machinery including steering gear and associated control systems, electrical installation and other equipment comply with the requirements of the present regulations, are in satisfactory condition and are fit for the service for which the ship is intended and that the required stability information is provided. In the case of tankers such a survey shall also include an inspection of the pump-rooms, cargo, bunker and ventilation piping systems and associated safety devices;
 - (ii) the renewal survey shall include an inspection of the structure, machinery and equipment as referred to in paragraph (b)(i) to ensure that they comply with the requirements of the present regulations, are in satisfactory condition and are fit for the service for which the ship is intended;
 - (iii) the intermediate survey shall include an inspection of the structure, boilers and other pressure vessels, machinery and equipment, the steering gear and the associated control systems and electrical installations to ensure that they remain satisfactory for the service for which the ship is intended. In the case of tankers, the survey shall also include an inspection of the pump-rooms, cargo, bunker and ventilation piping systems and associated safety devices and the testing of insulation resistance of electrical installations in dangerous zones;
 - (iv) the annual survey shall include a general inspection of the structure, machinery and equipment referred to in paragraph (b)(i), to ensure that they have been maintained in accordance with regulation 11(a) and that they remain satisfactory for the service for which the ship is intended;
 - (v) the inspection of the outside of the ship's bottom and the survey of related items inspected at the same time shall be such as to ensure that they remain satisfactory for the service for which the ship is intended.
- (c) The intermediate and annual surveys and the inspections of the outside of the ship's bottom referred to in paragraphs (a)(iii), (a)(iv) and (a)(v) shall be endorsed on the Cargo Ship Safety Construction Certificate.

Regulation 11

*Maintenance of conditions after survey**

- (a) The condition of the ship and its equipment shall be maintained to conform with the provisions of the present regulations to ensure that the ship in all respects will remain fit to proceed to sea without danger to the ship or persons on board.
- (b) After any survey of the ship under regulations 7, 8, 9 or 10 has been completed, no change shall be made in the structural arrangements, machinery, equipment and other items covered by the survey, without the sanction of the Administration.
- (c) Whenever an accident occurs to a ship or a defect is discovered, either of which affects the safety of the ship or the efficiency or completeness of its life-saving appliances or other equipment, the master or owner of the ship shall report at the earliest opportunity to the Administration, the nominated surveyor or recognized organization responsible for issuing the relevant certificate, who shall cause investigations to be initiated to determine whether a survey, as required by regulations 7, 8, 9 or 10, is necessary. If the ship is in a port of another Contracting Government, the master or owner shall also report immediately to the appropriate authorities of the port State and the nominated surveyor or recognized organization shall ascertain that such a report has been made.

* Refer to *Ship design, construction, repair and maintenance* (MSC/Circ.1070); *Shipboard technical operating and maintenance manuals* (MSC.1/Circ.1253) and the relevant instruments as referred to in the footnotes of other chapters.

Regulation 12

*Issue or endorsement of certificates**

- (a) (i) a certificate called a Passenger Ship Safety Certificate shall be issued after an initial or renewal survey to a passenger ship which complies with the relevant requirements of chapters II-1, II-2, III, IV and V and any other relevant requirements of the present regulations;
- (ii) a certificate called a Cargo Ship Safety Construction Certificate shall be issued after an initial or renewal survey to a cargo ship which complies with the relevant requirements of chapters II-1 and II-2 (other than those relating to fire safety systems and appliances and fire control plans) and any other relevant requirements of the present regulations;
- (iii) a certificate called a Cargo Ship Safety Equipment Certificate shall be issued after an initial or renewal survey to a cargo ship which complies with the relevant requirements of chapters II-1, II-2, III and V and any other relevant requirements of the present regulations;
- (iv) a certificate called a Cargo Ship Safety Radio Certificate shall be issued after an initial or renewal survey to a cargo ship which complies with the relevant requirements of chapter IV and any other relevant requirements of the present regulations;
- (v) (1) a certificate called a Cargo Ship Safety Certificate may be issued after an initial or renewal survey to a cargo ship which complies with the relevant requirements of chapters II-1, II-2, III, IV and V and any other relevant requirements of the present regulations, as an alternative to the certificates referred to in paragraph (a)(ii), (a)(iii) and (a)(iv);
- (2) whenever in this chapter reference is made to a Cargo Ship Safety Construction Certificate, Cargo Ship Safety Equipment Certificate or Cargo Ship Safety Radio Certificate, it shall apply to a Cargo Ship Safety Certificate, if it is used as an alternative to these certificates;
- (vi) the Passenger Ship Safety Certificate, the Cargo Ship Safety Equipment Certificate, the Cargo Ship Safety Radio Certificate and the Cargo Ship Safety Certificate, referred to in subparagraphs (i), (iii), (iv) and (v), shall be supplemented by a Record of Equipment;
- (vii) when an exemption is granted to a ship under and in accordance with the provisions of the present regulations, a certificate called an Exemption Certificate shall be issued in addition to the certificates prescribed in this paragraph;
- (viii) the certificates referred to in this regulation shall be issued or endorsed either by the Administration or by any person or organization authorized by it. In every case, that Administration assumes full responsibility for the certificates.
- (b) A Contracting Government shall not issue certificates under, and in accordance with, the provisions of the International Convention for the Safety of Life at Sea, 1960, 1948 or 1929, after the date on which acceptance of the present Convention by the Government takes effect.

Regulation 13

Issue or endorsement of certificates by another Government

A Contracting Government may, at the request of the Administration, cause a ship to be surveyed and, if satisfied that the requirements of the present regulations are complied with, shall issue or authorize the issue of certificates to the ship and, where appropriate, endorse or authorize the endorsement of certificates on the ship in accordance with the present regulations. Any certificate so issued shall contain a statement to the effect that it has been issued at the request of the Government of the State the flag of which the ship is entitled to fly, and it shall have the same force and receive the same recognition as a certificate issued under regulation 12.

* Refer to *Recommendation on the use of national tonnage in applying international conventions* (resolution A.1073(28)); *Guidelines for the use of Electronic Certificates* (FAL.5/Circ.39/Rev.2); *Guidance on the timing of replacement of existing certificates by the certificates issued after the entry into force of amendments to certificates in IMO instruments* (MSC-MEPC.5/Circ.6); *Unified interpretation on the expiration date of statutory certificates* (MSC-MEPC.5/Circ.13) and *Unified interpretation of the date of completion of the survey and verification on which the certificates are based* (MSC-MEPC.5/Circ.3).

Regulation 14*Duration and validity of certificates**

(a) A Passenger Ship Safety Certificate shall be issued for a period not exceeding 12 months. A Cargo Ship Safety Construction Certificate, Cargo Ship Safety Equipment Certificate and Cargo Ship Safety Radio Certificate shall be issued for a period specified by the Administration which shall not exceed five years. An Exemption Certificate shall not be valid for longer than the period of the certificate to which it refers.

(b) (i) notwithstanding the requirements of paragraph (a), when the renewal survey is completed within three months before the expiry date of the existing certificate, the new certificate shall be valid from the date of completion of the renewal survey to:

(1) for a passenger ship, a date not exceeding 12 months from the date of expiry of the existing certificate;

(2) for a cargo ship, a date not exceeding five years from the date of expiry of the existing certificate;

(ii) when the renewal survey is completed after the expiry date of the existing certificate, the new certificate shall be valid from the date of completion of the renewal survey to:

(1) for a passenger ship, a date not exceeding 12 months from the date of expiry of the existing certificate;

(2) for a cargo ship, a date not exceeding five years from the date of expiry of the existing certificate;

(iii) when the renewal survey is completed more than three months before the expiry date of the existing certificate, the new certificate shall be valid from the date of completion of the renewal survey to:

(1) for a passenger ship, a date not exceeding 12 months from the date of completion of the renewal survey;

(2) for a cargo ship, a date not exceeding five years from the date of completion of the renewal survey.

(c) If a certificate other than a Passenger Ship Safety Certificate is issued for a period of less than five years, the Administration may extend the validity of the certificate beyond the expiry date to the maximum period specified in paragraph (a), provided that the surveys referred to in regulations 8, 9 and 10 applicable when a certificate is issued for a period of 5 years are carried out as appropriate.

(d) If a renewal survey has been completed and a new certificate cannot be issued or placed on board the ship before the expiry date of the existing certificate, the person or organization authorized by the Administration may endorse the existing certificate and such a certificate shall be accepted as valid for a further period which shall not exceed 5 months from the expiry date.

(e) If a ship at the time when a certificate expires is not in a port in which it is to be surveyed, the Administration may extend the period of validity of the certificate but this extension shall be granted only for the purpose of allowing the ship to complete its voyage to the port in which it is to be surveyed, and then only in cases where it appears proper and reasonable to do so. No certificate shall be extended for a period longer than three months, and a ship to which an extension is granted shall not, on its arrival in the port in which it is to be surveyed, be entitled by virtue of such extension to leave that port without having a new certificate. When the renewal survey is completed, the new certificate shall be valid to:

(i) for a passenger ship, a date not exceeding 12 months from the date of expiry of the existing certificate before the extension was granted;

(ii) for a cargo ship, a date not exceeding 5 years from the date of expiry of the existing certificate before the extension was granted.

* Refer to *Recommended conditions for the period of a certificate (MSC-MEPC.5/Circ.1)*; *Guidance on the timing of replacement of existing certificates by the certificates issued after the entry into force of amendments to certificates in IMO instruments (MSC-MEPC.5/Circ.6)*; *Guidelines for the use of Electronic Certificate (FAL.5/Circ.39/Rev.2)*; *Unified interpretation on the expiration date of statutory certificates (MSC-MEPC.5/Circ.13)* and *Unified interpretation of the date of completion of the survey and verification are based (MSC-MEPC.5/Circ.3)*.

- (f) A certificate issued to a ship engaged on short voyages which has not been extended under the foregoing provisions of this regulation may be extended by the Administration for a period of grace of up to one month from the date of expiry stated on it. When the renewal survey is completed, the new certificate shall be valid to:
- (i) for a passenger ship, a date not exceeding 12 months from the date of expiry of the existing certificate before the extension was granted;
 - (ii) for a cargo ship, a date not exceeding 5 years from the date of expiry of the existing certificate before the extension was granted.
- (g) In special circumstances, as determined by the Administration, a new certificate need not be dated from the date of expiry of the existing certificate as required by paragraphs (b)(ii), (e) or (f). In these special circumstances, the new certificate shall be valid to:
- (i) for a passenger ship, a date not exceeding 12 months from the date of completion of the renewal survey;
 - (ii) for a cargo ship, a date not exceeding five years from the date of completion of the renewal survey.
- (h) If an annual, intermediate or periodical survey is completed before the period specified in the relevant regulations then:
- (i) the anniversary date shown on the relevant certificate shall be amended by endorsement to a date which shall not be more than three months later than the date on which the survey was completed;
 - (ii) the subsequent annual, intermediate or periodical survey required by the relevant regulations shall be completed at the intervals prescribed by these regulations using the new anniversary date;
 - (iii) the expiry date may remain unchanged provided one or more annual, intermediate or periodical surveys, as appropriate, are carried out so that the maximum intervals between the surveys prescribed by the relevant regulations are not exceeded.
- (i) A certificate issued under regulation 12 or 13 shall cease to be valid in any of the following cases:
- (i) if the relevant surveys and inspections are not completed within the periods specified under regulations 7(a), 8(a), 9(a) and 10(a);
 - (ii) if the certificate is not endorsed in accordance with the present regulations;
 - (iii) upon transfer of the ship to the flag of another State. A new certificate shall only be issued when the Government issuing the new certificate is fully satisfied that the ship is in compliance with the requirements of regulation 11(a) and (b). In the case of a transfer between Contracting Governments, if requested within three months after the transfer has taken place, the Government of the State whose flag the ship was formerly entitled to fly shall, as soon as possible, transmit to the Administration copies of the certificates carried by the ship before a transfer and, if available, copies of the relevant survey reports.

Regulation 15

*Forms of certificates and records of equipment**

The certificates and records of equipment shall be drawn up in the form corresponding to the models given in the appendix to the annex to the present Convention. If the language used is neither English nor French, the text shall include a translation into one of these languages.†

* Refer to *Guidelines for the use of Electronic Certificate* (FAL.5/Circ.39/Rev.2) and the information collected via the Global Integrated Shipping Information System (GISIS).

† Refer to *Translation of the text of certificates* (resolution A.561(14)).

Regulation 16*Availability of certificates**

The certificates issued under regulations 12 and 13 shall be readily available on board for examination at all times.

Regulation 17*Acceptance of certificates*

Certificates issued under the authority of a Contracting Government shall be accepted by the other Contracting Governments for all purposes covered by the present Convention. They shall be regarded by the other Contracting Governments as having the same force as certificates issued by them.

Regulation 18*Qualification of certificates*

(a) If in the course of a particular voyage a ship has on board a number of persons less than the total number stated in the Passenger Ship Safety Certificate and is in consequence, in accordance with the provisions of the present regulations, free to carry a smaller number of lifeboats and other life-saving appliances than that stated in the certificate, an annex may be issued by the Government, person or organization referred to in regulation 12 or 13 of this chapter.

(b) This annex shall state that in the circumstances there is no infringement of the provisions of the present regulations. It shall be annexed to the certificate and shall be substituted for it in so far as the life-saving appliances are concerned. It shall be valid only for the particular voyage for which it is issued.

Regulation 19*Control[†]*

(a) Every ship when in a port of another Contracting Government is subject to control by officers duly authorized by such Government in so far as this control is directed towards verifying that the certificates issued under regulation 12 or regulation 13 are valid.

(b) Such certificates, if valid, shall be accepted unless there are clear grounds for believing that the condition of the ship or of its equipment does not correspond substantially with the particulars of any of the certificates or that the ship and its equipment are not in compliance with the provisions of regulation 11(a) and (b).

(c) In the circumstances given in paragraph (b) or where a certificate has expired or ceased to be valid, the officer carrying out the control shall take steps to ensure that the ship shall not sail until it can proceed to sea or leave the port for the purpose of proceeding to the appropriate repair yard without danger to the ship or persons on board.

(d) In the event of this control giving rise to an intervention of any kind, the officer carrying out the control shall forthwith inform, in writing, the Consul or, in his absence, the nearest diplomatic representative of the State whose flag the ship is entitled to fly[†] of all the circumstances in which intervention was deemed necessary. In addition, nominated surveyors or recognized organizations responsible for the issue of the certificates shall also be notified. The facts concerning the intervention shall be reported to the Organization.

* Refer to *Retention of original records/documents on board ships* (MSC-MEPC.4/Circ.1) and *Guidance on the timing of replacement of existing certificates by the certificates issued after the entry into force of amendments to certificates in IMO instruments* (MSC-MEPC.5/Circ.6).

[†] Refer to *Procedures for port State control, 2019* (resolution A.1138(31)); *IMO Instruments Implementation Code (III Code)* (resolution A.1070(28)); *Guidance to port State control officers on the non-security related elements of the 2002 SOLAS amendments* (MSC/Circ.1113); *Measures to improve port State control procedures* (MSC/Circ.11011-MEPC/Circ.383); *Code of good practice for port State control officers* (MSC-MEPC.4/Circ.2); *National contact points for safety and pollution prevention and response* (MSC-MEPC.6/Circ.18, as may be amended), and the information collected via the Global Integrated Shipping Information System (GISIS).

(e) The port State authority concerned shall notify all relevant information about the ship to the authorities of the next port of call, in addition to parties mentioned in paragraph (d), if it is unable to take action as specified in paragraphs (c) and (d) or if the ship has been allowed to proceed to the next port of call.

(f) When exercising control under this regulation all possible efforts shall be made to avoid a ship being unduly detained or delayed. If a ship is thereby unduly detained or delayed it shall be entitled to compensation for any loss or damage suffered.

Regulation 20

Privileges

The privileges of the present Convention may not be claimed in favour of any ship unless it holds appropriate valid certificates.

Part C

Casualties

Regulation 21 *Casualties**

- (a) Each Administration undertakes to conduct an investigation of any casualty occurring to any of its ships subject to the provisions of the present Convention when it judges that such an investigation may assist in determining what changes in the present regulations might be desirable.
- (b) Each Contracting Government undertakes to supply the Organization with pertinent information concerning the findings of such investigations. No reports or recommendations of the Organization based upon such information shall disclose the identity or nationality of the ships concerned or in any manner fix or imply responsibility upon any ship or person.

* See additional requirements for the investigation of marine casualties and incidents in regulation XI-1/6.

Chapter II-1

Construction – Structure,
subdivision and stability, machinery
and electrical installations

Chapter II-1

Construction – Structure, subdivision and stability, machinery and electrical installations

Part A	General	
Regulation 1	Application	43
Regulation 2	Definitions	44
Regulation 3	Definitions relating to parts C, D and E	46
Part A-1	Structure of ships	
Regulation 3-1	Structural, mechanical and electrical requirements for ships	49
Regulation 3-2	Protective coatings of dedicated seawater ballast tanks in all types of ships and double-side skin spaces of bulk carriers	49
Regulation 3-3	Safe access to tanker bows	50
Regulation 3-4	Emergency towing arrangements and procedures	50
Regulation 3-5	New installation of materials containing asbestos	51
Regulation 3-6	Access to and within spaces in, and forward of, the cargo area of oil tankers and bulk carriers	51
Regulation 3-7	Construction drawings maintained on board and ashore	53
Regulation 3-8	Towing and mooring equipment	53
Regulation 3-9	Means of embarkation on and disembarkation from ships	54
Regulation 3-10	Goal-based ship construction standards for bulk carriers and oil tankers	54
Regulation 3-11	Corrosion protection of cargo oil tanks of crude oil tankers	55
Regulation 3-12	Protection against noise	56
Part B	Subdivision and stability	
Regulation 4	General	57
Part B-1	Stability	
Regulation 5	Intact stability	59
Regulation 5-1	Stability information to be supplied to the master	59
Regulation 6	Required subdivision index <i>R</i>	60
Regulation 7	Attained subdivision index <i>A</i>	61
Regulation 7-1	Calculation of the factor <i>p_i</i>	62
Regulation 7-2	Calculation of the factor <i>s_i</i>	64
Regulation 7-3	Permeability	69
Regulation 8	Special requirements concerning passenger ship stability	69
Regulation 8-1	System capabilities and operational information after a flooding casualty on passenger ships	70

Part B-2	Subdivision, watertight and weathertight integrity	
Regulation 9	Double bottoms in passenger ships and cargo ships other than tankers.	71
Regulation 10	Construction of watertight bulkheads.	72
Regulation 11	Initial testing of watertight bulkheads, etc.	72
Regulation 12	Peak and machinery space bulkheads, shaft tunnels, etc.	73
Regulation 13	Openings in watertight bulkheads below the bulkhead deck in passenger ships	74
Regulation 13-1	Openings in watertight bulkheads and internal decks in cargo ships.	78
Regulation 14	Passenger ships carrying goods vehicles and accompanying personnel.	78
Regulation 15	Openings in the shell plating below the bulkhead deck of passenger ships and the freeboard deck of cargo ships	79
Regulation 15-1	External openings in cargo ships	80
Regulation 16	Construction and initial tests of watertight closures.	81
Regulation 16-1	Construction and initial tests of watertight decks, trunks, etc.	81
Regulation 17	Internal watertight integrity of passenger ships above the bulkhead deck	81
Regulation 17-1	Integrity of the hull and superstructure, damage prevention and control on ro-ro passenger ships	82
Part B-3	Subdivision load line assignment for passenger ships	
Regulation 18	Assigning, marking and recording of subdivision load lines for passenger ships	83
Part B-4	Stability management	
Regulation 19	Damage control information	84
Regulation 19-1	Damage control drills for passenger ships.	84
Regulation 20	Loading of ships.	85
Regulation 21	Periodical operation and inspection of watertight doors, etc., in passenger ships	85
Regulation 22	Prevention and control of water ingress, etc.	86
Regulation 22-1	Flooding detection systems for passenger ships carrying 36 or more persons	87
Regulation 23	Special requirements for ro-ro passenger ships.	88
Regulation 24	Additional requirements for prevention and control of water ingress, etc. in cargo ships	88
Regulation 25	Water level detectors on single hold cargo ships other than bulk carriers	89
Part C	Machinery installations	
Regulation 26	General.	90
Regulation 27	Machinery.	91
Regulation 28	Means of going astern	92
Regulation 29	Steering gear	92
Regulation 30	Additional requirements for electric and electrohydraulic steering gear.	97
Regulation 31	Machinery controls	98
Regulation 32	Steam boilers and boiler feed systems	99
Regulation 33	Steam pipe systems	100

Regulation 34	Air pressure systems	100
Regulation 35	Ventilating systems in machinery spaces	100
Regulation 35-1	Bilge pumping arrangements	101
Regulation 36	[Blank]	104
Regulation 37	Communication between navigation bridge and machinery space	104
Regulation 38	Engineers' alarm	104
Regulation 39	Location of emergency installations in passenger ships	104
Part D	Electrical installations	
Regulation 40	General	105
Regulation 41	Main source of electrical power and lighting systems	105
Regulation 42	Emergency source of electrical power in passenger ships	107
Regulation 42-1	Supplementary emergency lighting for ro-ro passenger ships	110
Regulation 43	Emergency source of electrical power in cargo ships	110
Regulation 44	Starting arrangements for emergency generating sets	113
Regulation 45	Precautions against shock, fire and other hazards of electrical origin	114
Part E	Additional requirements for periodically unattended machinery spaces	
Regulation 46	General	117
Regulation 47	Fire precautions	117
Regulation 48	Protection against flooding	117
Regulation 49	Control of propulsion machinery from the navigation bridge	118
Regulation 50	Communication	118
Regulation 51	Alarm system	119
Regulation 52	Safety systems	119
Regulation 53	Special requirements for machinery, boiler and electrical installations	119
Regulation 54	Special consideration in respect of passenger ships	120
Part F	Alternative design and arrangements	
Regulation 55	Alternative design and arrangements	121
Part G	Ships using low-flashpoint fuels	
Regulation 56	Application	123
Regulation 57	Requirements for ships using low-flashpoint fuels	123
Unified Interpretations for Chapter II-1		125
Appendices to Unified Interpretations of Chapter II-1		147

Part A

General

Regulation 1

*Application**

1.1 Unless expressly provided otherwise, this chapter shall apply to ships the keels of which are laid or which are at a similar stage of construction on or after 1 January 2009.

1.1.1 Unless expressly provided otherwise, parts B, B-1, B-2 and B-4 of this chapter shall only apply to ships:

- .1 for which the building contract is placed on or after 1 January 2020; or
- .2 in the absence of a building contract, the keel of which is laid or which are at a similar stage of construction on or after 1 July 2020; or
- .3 the delivery of which is on or after 1 January 2024.

1.1.2 Unless expressly provided otherwise, for ships not subject to the provisions of sub-paragraph 1.1.1 but constructed on or after 1 January 2009, the Administration shall:

- .1 ensure that the requirements for parts B, B-1, B-2 and B-4 which are applicable under chapter II-1 of the International Convention for the Safety of Life at Sea, 1974, as amended by resolutions MSC.216(82), MSC.269(85) and MSC.325(90) are complied with; and
- .2 ensure that the requirements of regulations 8-1.3 and 19-1 are complied with.

1.2 For the purpose of this chapter, the term *a similar stage of construction* means the stage at which:

- .1 construction identifiable with a specific ship begins; and
- .2 assembly of that ship has commenced comprising at least 50 tonnes or 1% of the estimated mass of all structural material, whichever is less.

1.3 For the purpose of this chapter:

- .1 the expression *ships constructed* means ships the keels of which are laid or which are at a similar stage of construction;
- .2 the expression *all ships* means ships constructed before, on or after 1 January 2009;
- .3 a cargo ship, whenever built, which is converted to a passenger ship shall be treated as a passenger ship constructed on the date on which such a conversion commences.

2 Unless expressly provided otherwise, for ships constructed before 1 January 2009, the Administration shall:

- .1 ensure that the requirements which are applicable under chapter II-1 of the International Convention for the Safety of Life at Sea, 1974, as amended by resolutions MSC.1(XLV), MSC.6(48), MSC.11(55), MSC.12(56), MSC.13(57), MSC.19(58), MSC.26(60), MSC.27(61), resolution 1 of the 1995 SOLAS Conference, MSC.47(66), MSC.57(67), MSC.65(68), MSC.69(69), MSC.99(73), MSC.134(76), MSC.151(78) and MSC.170(79) are complied with; and
- .2 ensure that the requirements of regulations 8-1.3 and 19-1 are complied with.

* Refer to *Unified Interpretation of the application of regulations governed by the building contract date, the keel laying date and the delivery date for the requirements of the SOLAS and MARPOL Conventions* (MSC-MEPC.5/Circ.8).

3 All ships which undergo repairs, alterations, modifications and outfitting related thereto shall continue to comply with at least the requirements previously applicable to these ships. Such ships, if constructed before the date on which any relevant amendments enter into force, shall, as a rule, comply with the requirements for ships constructed on or after that date to at least the same extent as they did before undergoing such repairs, alterations, modifications or outfitting. Repairs, alterations and modifications of a major character and outfitting related thereto shall meet the requirements for ships constructed on or after the date on which any relevant amendments enter into force, insofar as the Administration deems reasonable and practicable.*

SEE INTERPRETATION 1

4 The Administration of a State may, if it considers that the sheltered nature and conditions of the voyage are such as to render the application of any specific requirements of this chapter unreasonable or unnecessary, exempt from those requirements individual ships or classes of ships entitled to fly the flag of that State which, in the course of their voyage, do not proceed more than 20 miles from the nearest land.

5 In the case of passenger ships which are employed in special trades for the carriage of large numbers of special trade passengers, such as the pilgrim trade, the Administration of the State whose flag such ships are entitled to fly, if satisfied that it is impracticable to enforce compliance with the requirements of this chapter, may exempt such ships from those requirements, provided that they comply fully with the provisions of:

- .1 the rules annexed to the Special Trade Passenger Ships Agreement, 1971; and
- .2 the rules annexed to the Protocol on Space Requirements for Special Trade Passenger Ships, 1973.

Regulation 2

Definitions

For the purpose of this chapter, unless expressly provided otherwise:

- 1 *Subdivision length* (L_s) of the ship is the greatest projected moulded length of that part of the ship at or below deck or decks limiting the vertical extent of flooding with the ship at the deepest subdivision draught.
- 2 *Amidships* is at the middle of the length (L).
- 3 *Aft terminal* is the aft limit of the subdivision length.
- 4 *Forward terminal* is the forward limit of the subdivision length.
- 5 *Length* (L) is the length as defined in the International Convention on Load Lines in force.
- 6 *Freeboard deck* is the deck as defined in the International Convention on Load Lines in force.
- 7 *Forward perpendicular* is the forward perpendicular as defined in the International Convention on Load Lines in force.
- 8 *Breadth* (B) is the greatest moulded breadth of the ship at or below the deepest subdivision draught.
- 9 *Draught* (d) is the vertical distance from the keel line at:
 - .1 amidships, for ships subject to the provisions of regulation II-1/1.1.1.1; and
 - .2 the mid-point of the subdivision length (L_s), for ships not subject to the provisions of regulation II-1/1.1.1.1 but constructed on or after 1 January 2009, to the waterline in question.
- 10 *Deepest subdivision draught* (d_s) is the summer load line draught of the ship.
- 11 *Light service draught* (d_l) is the service draught corresponding to the lightest anticipated loading and associated tankage, including, however, such ballast as may be necessary for stability and/or immersion. Passenger ships should include the full complement of passengers and crew on board.
- 12 *Partial subdivision draught* (d_p) is the light service draught plus 60% of the difference between the light service draught and the deepest subdivision draught.

* Refer to *Interpretation of alterations and modifications of a major character* (MSC.1/Circ.1246).

13 *Trim* is the difference between the draught forward and the draught aft, where the draughts are measured at the forward and aft:

- .1 perpendiculars respectively, as defined in the International Convention on Load Lines in force, for ships subject to the provisions of regulation II-1/1.1.1.1; and
- .2 terminals respectively, for ships not subject to the provisions of regulation II-1/1.1.1.1 but constructed on or after 1 January 2009, disregarding any rake of keel.

14 *Permeability* (μ) of a space is the proportion of the immersed volume of that space which can be occupied by water.

15 *Machinery spaces* are spaces between the watertight boundaries of a space containing the main and auxiliary propulsion machinery, including boilers, generators and electric motors primarily intended for propulsion. In the case of unusual arrangements, the Administration may define the limits of the machinery spaces.

16 *Weathertight* means that in any sea conditions water will not penetrate into the ship.

17 *Watertight* means having scantlings and arrangements capable of preventing the passage of water in any direction under the head of water likely to occur in intact and damaged conditions. In the damaged condition, the head of water is to be considered in the worst situation at equilibrium, including intermediate stages of flooding.

18 *Design pressure* means the hydrostatic pressure for which each structure or appliance assumed watertight in the intact and damage stability calculations is designed to withstand.

19 *Bulkhead deck* in a passenger ship means the uppermost deck:

- .1 to which the main bulkheads and the ship's shell are carried watertight, for ships subject to the provisions of regulation II-1/1.1.1.1; and
- .2 at any point in the subdivision length (L_s) to which the main bulkheads and the ship's shell are carried watertight and the lowermost deck from which passenger and crew evacuation will not be impeded by water in any stage of flooding for damage cases defined in regulation 8 and in part B-2 of this chapter, for ships not subject to the provisions of regulation II-1/1.1.1.1 but constructed on or after 1 January 2009.

The bulkhead deck may be a stepped deck. In a cargo ship not subject to the provisions of regulation II-1/1.1.1.1 but constructed on or after 1 January 2009, the freeboard deck may be taken as the bulkhead deck.

20 *Deadweight* is the difference in tonnes between the displacement of a ship in water of a specific gravity of 1.025 at the draught corresponding to the assigned summer freeboard and the lightweight of the ship.

SEE INTERPRETATION 2

21 *Lightweight* is the displacement of a ship in tonnes without cargo, fuel, lubricating oil, ballast water, fresh water and feedwater in tanks, consumable stores, and passengers and crew and their effects.

SEE INTERPRETATION 3

22 *Oil tanker* is the oil tanker defined in regulation 1 of Annex I of the Protocol of 1978 relating to the International Convention for the Prevention of Pollution from Ships, 1973.

23 *Ro-ro passenger ship* means a passenger ship with ro-ro spaces or special category spaces as defined in regulation II-2/3.

24 *Bulk carrier* means a bulk carrier as defined in regulation XII/1.1.

25 *Keel line* is a line parallel to the slope of the keel passing amidships through:

- .1 the top of the keel at centreline or line of intersection of the inside of shell plating with the keel if a bar keel extends below that line, on a ship with a metal shell; or
- .2 in wood and composite ships, the distance is measured from the lower edge of the keel rabbet. When the form at the lower part of the midship section is of a hollow character, or where thick

garboards are fitted, the distance is measured from the point where the line of the flat of the bottom continued inward intersects the centreline amidships.

26 *2008 IS Code* means the International Code on Intact Stability, 2008, consisting of an introduction, part A (the provisions of which shall be treated as mandatory) and part B (the provisions of which shall be treated as recommendatory), as adopted by resolution MSC.267(85), provided that:

- .1 amendments to the introduction and part A of the Code are adopted, brought into force and take effect in accordance with the provisions of article VIII of the present Convention concerning the amendment procedures applicable to the annex other than chapter I thereof; and
- .2 amendments to part B of the Code are adopted by the Maritime Safety Committee in accordance with its Rules of Procedure.

27 *Goal-based Ship Construction Standards for Bulk Carriers and Oil Tankers* means the International Goal-based Ship Construction Standards for Bulk Carriers and Oil Tankers, adopted by the Maritime Safety Committee by resolution MSC.287(87), as may be amended by the Organization, provided that such amendments are adopted, brought into force and take effect in accordance with the provisions of article VIII of the present Convention concerning the amendment procedures applicable to the annex other than chapter I thereof.

28 *IGF Code* means the International Code of Safety for Ships using Gases or other Low-Flashpoint Fuels as adopted by the Maritime Safety Committee of the Organization by resolution MSC.391(95), as may be amended by the Organization, provided that such amendments are adopted, brought into force and take effect in accordance with the provisions of article VIII of the present Convention concerning the amendment procedures applicable to the annex other than chapter I.

29 *Low-flashpoint fuel* means gaseous or liquid fuel having a flashpoint lower than otherwise permitted under regulation II-2/4.2.1.1.

Regulation 3

Definitions relating to parts C, D and E

For the purpose of parts C, D and E, unless expressly provided otherwise:

1 *Steering gear control system* is the equipment by which orders are transmitted from the navigating bridge to the steering gear power units.

Steering gear control systems comprise transmitters, receivers, hydraulic control pumps and their associated motors, motor controllers, piping and cables.

2 *Main steering gear* is the machinery, rudder actuators, steering gear, power units, if any, and ancillary equipment and the means of applying torque to the rudder stock (e.g. tiller or quadrant) necessary for effecting movement of the rudder for the purpose of steering the ship under normal service conditions.

3 *Steering gear power unit* is:

- .1 in the case of electric steering gear, an electric motor and its associated electrical equipment;
- .2 in the case of electrohydraulic steering gear, an electric motor and its associated electrical equipment and connected pump; or
- .3 in the case of other hydraulic steering gear, a driving engine and connected pump.

4 *Auxiliary steering gear* is the equipment other than any part of the main steering gear necessary to steer the ship in the event of failure of the main steering gear but not including the tiller, quadrant or components serving the same purpose.

5 *Normal operational and habitable condition* is a condition under which the ship as a whole, the machinery, services, means and aids ensuring propulsion, ability to steer, safe navigation, fire and flooding safety, internal and external communications and signals, means of escape, and emergency boat winches, as well as the designed comfortable conditions of habitability, are in working order and functioning normally.

6 *Emergency condition* is a condition under which any services needed for normal operational and habitable conditions are not in working order due to failure of the main source of electrical power.

7 *Main source of electrical power* is a source intended to supply electrical power to the main switchboard for distribution to all services necessary for maintaining the ship in normal operational and habitable conditions.

8 *Dead ship condition* is the condition under which the main propulsion plant, boilers and auxiliaries are not in operation due to the absence of power.

9 *Main generating station* is the space in which the main source of electrical power is situated.

10 *Main switchboard* is a switchboard which is directly supplied by the main source of electrical power and is intended to distribute electrical energy to the ship's services.

11 *Emergency switchboard* is a switchboard which in the event of failure of the main electrical power supply system is directly supplied by the emergency source of electrical power or the transitional source of emergency power and is intended to distribute electrical energy to the emergency services.

12 *Emergency source of electrical power* is a source of electrical power, intended to supply the emergency switchboard in the event of a failure of the supply from the main source of electrical power.

13 *Power actuating system* is the hydraulic equipment provided for supplying power to turn the rudder stock, comprising a steering gear power unit or units, together with the associated pipes and fittings, and a rudder actuator. The power actuating systems may share common mechanical components (i.e. tiller, quadrant and rudder stock) or components serving the same purpose.

14 *Maximum ahead service speed* is the greatest speed which the ship is designed to maintain in service at sea at the deepest seagoing draught.

15 *Maximum astern speed* is the speed which it is estimated the ship can attain at the designed maximum astern power at the deepest seagoing draught.

16 *Machinery spaces* are all machinery spaces of category A and all other spaces containing propelling machinery, boilers, oil fuel units, steam and internal-combustion engines, generators and major electrical machinery, oil filling stations, refrigerating, stabilizing, ventilation and air conditioning machinery, and similar spaces, and trunks to such spaces.

17 *Machinery spaces of category A* are those spaces and trunks to such spaces which contain:

- .1 internal-combustion machinery used for main propulsion;
- .2 internal-combustion machinery used for purposes other than main propulsion where such machinery has in the aggregate a total power output of not less than 375 kW; or
- .3 any oil-fired boiler or oil fuel unit.

18 *Control stations* are those spaces in which the ship's radio or main navigating equipment or the emergency source of power is located or where the fire recording or fire control equipment is centralized.

19 *Chemical tanker* is a cargo ship constructed or adapted and used for the carriage in bulk of any liquid product listed in either:

- .1 chapter 17 of the International Code for the Construction and Equipment of Ships Carrying Dangerous Chemicals in Bulk adopted by the Maritime Safety Committee by resolution MSC.4(48), hereinafter referred to as "the International Bulk Chemical Code", as may be amended by the Organization; or
- .2 chapter VI of the Code for the Construction and Equipment of Ships Carrying Dangerous Chemicals in Bulk adopted by the Assembly of the Organization by resolution A.212(VII), hereinafter referred to as "the Bulk Chemical Code", as has been or may be amended by the Organization,

whichever is applicable.

II-1

20 *Gas carrier* is a cargo ship constructed or adapted and used for the carriage in bulk of any liquefied gas or other products listed in either:

- .1 chapter 19 of the International Code for the Construction and Equipment of Ships Carrying Liquefied Gases in Bulk adopted by the Maritime Safety Committee by resolution MSC.5(48), hereinafter referred to as “the International Gas Carrier Code”, as may be amended by the Organization; or
- .2 chapter XIX of the Code for the Construction and Equipment of Ships Carrying Liquefied Gases in Bulk adopted by the Organization by resolution A.328(IX), hereinafter referred to as “the Gas Carrier Code”, as has been or may be amended by the Organization,

whichever is applicable.

Part A-1

Structure of ships

Regulation 3-1

Structural, mechanical and electrical requirements for ships

In addition to the requirements contained elsewhere in the present regulations, ships shall be designed, constructed and maintained in compliance with the structural, mechanical and electrical requirements of a classification society which is recognized by the Administration in accordance with the provisions of regulation XI-1/1, or with applicable national standards of the Administration which provide an equivalent level of safety.

Regulation 3-2

*Protective coatings of dedicated seawater ballast tanks in all types of ships and double-side skin spaces of bulk carriers**

SEE INTERPRETATION 4

- 1 Paragraphs 2 and 4 of this regulation shall apply to ships of not less than 500 gross tonnage:
 - .1 for which the building contract is placed on or after 1 July 2008; or
 - .2 in the absence of a building contract, the keels of which are laid or which are at a similar stage of construction on or after 1 January 2009; or
 - .3 the delivery of which is on or after 1 July 2012.†
- 2 All dedicated seawater ballast tanks arranged in ships and double-side skin spaces arranged in bulk carriers of 150 m in length and upwards shall be coated during construction in accordance with the *Performance standard for protective coatings for dedicated seawater ballast tanks in all types of ships and double-side skin spaces of bulk carriers*, adopted by the Maritime Safety Committee by resolution MSC.215(82), as may be amended by the Organization, provided that such amendments are adopted, brought into force and take effect in accordance with the provisions of article VIII of the present Convention concerning the amendment procedures applicable to the annex other than chapter I.

SEE INTERPRETATION 5

- 3 All dedicated seawater ballast tanks arranged in oil tankers and bulk carriers constructed on or after 1 July 1998, for which paragraph 2 is not applicable, shall comply with the requirements of regulation II-1/3-2 adopted by resolution MSC.47(66).
- 4 Maintenance of the protective coating system shall be included in the overall ship's maintenance scheme. The effectiveness of the protective coating system shall be verified during the life of a ship by the

* Refer to *Guidelines for the selection, application and maintenance of corrosion prevention systems of dedicated seawater ballast tanks* (resolution A.798(19)).

† Refer to *Unified interpretation of "unforeseen delay in delivery of ships"* (MSC.1/Circ.1247).

Administration or an organization recognized by the Administration, based on the guidelines developed by the Organization.*

SEE INTERPRETATION 5

Regulation 3-3

Safe access to tanker bows

1 For the purpose of this regulation and regulation 3-4, tankers include oil tankers as defined in regulation 2.22, chemical tankers as defined in regulation VII/8.2 and gas carriers as defined in regulation VII/11.2.

2 Every tanker shall be provided with the means to enable the crew to gain safe access to the bow even in severe weather conditions. Such means of access shall be approved by the Administration based on the guidelines developed by the Organization.†

Regulation 3-4

Emergency towing arrangements and procedures

1 Emergency towing arrangements on tankers

1.1 Emergency towing arrangements shall be fitted at both ends on board every tanker of not less than 20,000 tonnes deadweight.

1.2 For tankers constructed on or after 1 July 2002:

- .1 the arrangements shall, at all times, be capable of rapid deployment in the absence of main power on the ship to be towed and easy connection to the towing ship. At least one of the emergency towing arrangements shall be pre-rigged ready for rapid deployment; and
- .2 emergency towing arrangements at both ends shall be of adequate strength taking into account the size and deadweight of the ship, and the expected forces during bad weather conditions. The design and construction and prototype testing of emergency towing arrangements shall be approved by the Administration, based on the guidelines developed by the Organization.‡

1.3 For tankers constructed before 1 July 2002, the design and construction of emergency towing arrangements shall be approved by the Administration, based on the guidelines developed by the Organization.‡

2 Emergency towing procedures on ships

2.1 This paragraph applies to:

- .1 all passenger ships, not later than 1 January 2010;
- .2 cargo ships constructed on or after 1 January 2010; and
- .3 cargo ships constructed before 1 January 2010, not later than 1 January 2012.

2.2 Ships shall be provided with a ship-specific emergency towing procedure. Such a procedure shall be carried aboard the ship for use in emergency situations and shall be based on existing arrangements and equipment available on board the ship.

* Refer to *Guidelines for maintenance and repair of protective coatings* (MSC.1/Circ.1330).

† Refer to *Guidelines for safe access to tanker bows* (resolution MSC.62(67)).

‡ Refer to *Guidelines on emergency towing arrangements for tankers* (resolution MSC.35(63), as amended) and LL.3/Circ.130, section 5.

2.3 The procedure* shall include:

- .1 drawings of fore and aft deck showing possible emergency towing arrangements;
- .2 inventory of equipment on board that can be used for emergency towing;
- .3 means and methods of communication; and
- .4 sample procedures to facilitate the preparation for and conducting of emergency towing operations.

Regulation 3-5

New installation of materials containing asbestos†

SEE INTERPRETATION 6

1 This regulation shall apply to materials used for the structure, machinery, electrical installations and equipment covered by the present Convention.

2 From 1 January 2011, for all ships, new installation of materials which contain asbestos shall be prohibited.

Regulation 3-6

Access to and within spaces in, and forward of, the cargo area of oil tankers and bulk carriers

SEE INTERPRETATION 7

1 Application

SEE INTERPRETATION 8

1.1 Except as provided for in paragraph 1.2, this regulation applies to oil tankers of 500 gross tonnage and over and bulk carriers, as defined in regulation IX/1, of 20,000 gross tonnage and over, constructed on or after 1 January 2006.

1.2 Oil tankers of 500 gross tonnage and over constructed on or after 1 October 1994 but before 1 January 2005 shall comply with the provisions of regulation II-1/12-2 adopted by resolution MSC.27(61).

2 Means of access to cargo and other spaces

2.1 Each space shall be provided with means of access to enable, throughout the life of a ship, overall and close-up inspections and thickness measurements of the ship's structures to be carried out by the Administration, the Company, as defined in regulation IX/1, and the ship's personnel and others as necessary. Such means of access shall comply with the requirements of paragraph 5 and with the *Technical provisions for means of access for inspections*, adopted by the Maritime Safety Committee by resolution MSC.133(76)‡, as may be amended by the Organization, provided that such amendments are adopted, brought into force and take effect in accordance with the provisions of article VIII of the present Convention concerning the amendment procedures applicable to the annex other than chapter I.

SEE INTERPRETATION 9

2.2 Where a permanent means of access may be susceptible to damage during normal cargo loading and unloading operations or where it is impracticable to fit permanent means of access, the Administration may

* Refer to *Guidelines for owners/operators on preparing emergency towing procedures* (MSC.1/Circ.1255).

† Refer to *Information on prohibiting the use of asbestos on board ships* (MSC.1/Circ.1374).

‡ Amended by resolution MSC.158(78).

allow, in lieu thereof, the provision of movable or portable means of access, as specified in the Technical provisions, provided that the means of attaching, rigging, suspending or supporting the portable means of access forms a permanent part of the ship's structure. All portable equipment shall be capable of being readily erected or deployed by ship's personnel.

SEE INTERPRETATION 10

2.3 The construction and materials of all means of access and their attachment to the ship's structure shall be to the satisfaction of the Administration. The means of access shall be subject to survey prior to, or in conjunction with, its use in carrying out surveys in accordance with regulation I/10.

SEE INTERPRETATION 11

3 Safe access to cargo holds, cargo tanks, ballast tanks and other spaces

3.1 Safe access* to cargo holds, cofferdams, ballast tanks, cargo tanks and other spaces in the cargo area shall be direct from the open deck and such as to ensure their complete inspection. Safe access to double-bottom spaces or to forward ballast tanks may be from a pump-room, deep cofferdam, pipe tunnel, cargo hold, double-hull space or similar compartment not intended for the carriage of oil or hazardous cargoes.

SEE INTERPRETATION 12

3.2 Tanks, and subdivisions of tanks, having a length of 35 m or more, shall be fitted with at least two access hatchways and ladders, as far apart as practicable. Tanks less than 35 m in length shall be served by at least one access hatchway and ladder. When a tank is subdivided by one or more swash bulkheads or similar obstructions which do not allow ready means of access to the other parts of the tank, at least two hatchways and ladders shall be fitted.

SEE INTERPRETATION 13

3.3 Each cargo hold shall be provided with at least two means of access as far apart as practicable. In general, these accesses should be arranged diagonally, for example one access near the forward bulkhead on the port side, the other one near the aft bulkhead on the starboard side.

4 Ship Structure Access Manual

4.1 A ship's means of access to carry out overall and close-up inspections and thickness measurements shall be described in a Ship Structure Access Manual approved by the Administration, an updated copy of which shall be kept on board. The Ship Structure Access Manual shall include the following for each space:

- .1** plans showing the means of access to the space, with appropriate technical specifications and dimensions;
- .2** plans showing the means of access within each space to enable an overall inspection to be carried out, with appropriate technical specifications and dimensions. The plans shall indicate from where each area in the space can be inspected;
- .3** plans showing the means of access within the space to enable close-up inspections to be carried out, with appropriate technical specifications and dimensions. The plans shall indicate the positions of critical structural areas, whether the means of access is permanent or portable and from where each area can be inspected;
- .4** instructions for inspecting and maintaining the structural strength of all means of access and means of attachment, taking into account any corrosive atmosphere that may be within the space;
- .5** instructions for safety guidance when rafting is used for close-up inspections and thickness measurements;

* Refer to Revised recommendations for entering enclosed spaces aboard ships (resolution A.1050(27)).

- .6 instructions for the rigging and use of any portable means of access in a safe manner;
- .7 an inventory of all portable means of access; and
- .8 records of periodical inspections and maintenance of the ship's means of access.

SEE INTERPRETATION 14

4.2 For the purpose of this regulation "critical structural areas" are locations which have been identified from calculations to require monitoring or from the service history of similar or sister ships to be sensitive to cracking, buckling, deformation or corrosion which would impair the structural integrity of the ship.

SEE INTERPRETATION 15

5 General technical specifications

5.1 For access through horizontal openings, hatches or manholes, the dimensions shall be sufficient to allow a person wearing a self-contained air-breathing apparatus and protective equipment to ascend or descend any ladder without obstruction and also provide a clear opening to facilitate the hoisting of an injured person from the bottom of the space. The minimum clear opening shall not be less than 600 mm × 600 mm. When access to a cargo hold is arranged through the cargo hatch, the top of the ladder shall be placed as close as possible to the hatch coaming. Access hatch coamings having a height greater than 900 mm shall also have steps on the outside in conjunction with the ladder.

SEE INTERPRETATION 16

5.2 For access through vertical openings, or manholes, in swash bulkheads, floors, girders and web frames providing passage through the length and breadth of the space, the minimum opening shall be not less than 600 mm × 800 mm at a height of not more than 600 mm from the bottom shell plating unless gratings or other footholds are provided.

SEE INTERPRETATION 17

5.3 For oil tankers of less than 5,000 tonnes deadweight, the Administration may approve, in special circumstances, smaller dimensions for the openings referred to in paragraphs 5.1 and 5.2, if the ability to traverse such openings or to remove an injured person can be proved to the satisfaction of the Administration.

Regulation 3-7

Construction drawings maintained on board and ashore

- 1 A set of as-built construction drawings* and other plans showing any subsequent structural alterations shall be kept on board a ship constructed on or after 1 January 2007.
- 2 An additional set of such drawings shall be kept ashore by the Company, as defined in regulation IX/1.2.

Regulation 3-8

Towing and mooring equipment

SEE INTERPRETATION 18

- 1 This regulation applies to ships constructed on or after 1 January 2007, but does not apply to emergency towing arrangements provided in accordance with regulation 3-4.
- 2 Ships shall be provided with arrangements, equipment and fittings of sufficient safe working load to enable the safe conduct of all towing and mooring operations associated with the normal operation of the ship.

* Refer to *As-built construction drawings to be maintained on board the ship and ashore* (MSC/Circ.1135).

3 Arrangements, equipment and fittings provided in accordance with paragraph 2 shall meet the appropriate requirements of the Administration or an organization recognized by the Administration under regulation I/6.*

4 Each fitting or item of equipment provided under this regulation shall be clearly marked with any restrictions associated with its safe operation, taking into account the strength of its attachment to the ship's structure.

Regulation 3-9

Means of embarkation on and disembarkation from ships

1 Ships constructed on or after 1 January 2010 shall be provided with means of embarkation on and disembarkation from ships for use in port and in port-related operations, such as gangways and accommodation ladders, in accordance with paragraph 2, unless the Administration deems that compliance with a particular provision is unreasonable or impractical.†

2 The means of embarkation and disembarkation required in paragraph 1 shall be constructed and installed based on the guidelines developed by the Organization.‡

3 For all ships the means of embarkation and disembarkation shall be inspected and maintained† in suitable condition for their intended purpose, taking into account any restrictions related to safe loading. All wires used to support the means of embarkation and disembarkation shall be maintained as specified in regulation III/20.4.

Regulation 3-10

Goal-based ship construction standards for bulk carriers and oil tankers

1 This regulation shall apply to oil tankers of 150 m in length and above and to bulk carriers of 150 m in length and above, constructed with single deck, top-side tanks and hopper side tanks in cargo spaces, excluding ore carriers and combination carriers:

- .1 for which the building contract is placed on or after 1 July 2016; or
- .2 in the absence of a building contract, the keels of which are laid or which are at a similar stage of construction on or after 1 July 2017; or
- .3 the delivery of which is on or after 1 July 2020.

2 Ships shall be designed and constructed for a specified design life to be safe and environmentally friendly, when properly operated and maintained under the specified operating and environmental conditions, in intact and specified damage conditions, throughout their life.

2.1 *Safe and environmentally friendly* means the ship shall have adequate strength, integrity and stability to minimize the risk of loss of the ship or pollution to the marine environment due to structural failure, including collapse, resulting in flooding or loss of watertight integrity.

2.2 *Environmentally friendly* also includes the ship being constructed of materials for environmentally acceptable recycling.

2.3 *Safety* also includes the ship's structure, fittings and arrangements providing for safe access, escape, inspection and proper maintenance and facilitating safe operation.

* Refer to *Guidance on shipboard towing and mooring equipment* (MSC/Circ.1175).

† Circumstances where compliance may be deemed unreasonable or impractical may include where the ship:

- .1 has small freeboards and is provided with boarding ramps; or
- .2 is engaged in voyages between designated ports where appropriate shore accommodation/embarkation ladders (platforms) are provided.

‡ Refer to *Guidelines for construction, installation, maintenance and inspection/survey of means of embarkation and disembarkation* (MSC.1/Circ.1331).

2.4 *Specified operating and environmental conditions* are defined by the intended operating area for the ship throughout its life and cover the conditions, including intermediate conditions, arising from cargo and ballast operations in port, waterways and at sea.

2.5 *Specified design life* is the nominal period that the ship is assumed to be exposed to operating and/or environmental conditions and/or the corrosive environment and is used for selecting appropriate ship design parameters. However, the ship's actual service life may be longer or shorter depending on the actual operating conditions and maintenance of the ship throughout its life cycle.

3 The requirements of paragraphs 2 to 2.5 shall be achieved through satisfying applicable structural requirements of an organization which is recognized by the Administration in accordance with the provisions of regulation XI-1/1, or national standards of the Administration, conforming to the functional requirements of the Goal-based Ship Construction Standards for Bulk Carriers and Oil Tankers.*

4 A Ship Construction File with specific information on how the functional requirements of the Goal-based Ship Construction Standards for Bulk Carriers and Oil Tankers have been applied in the ship design and construction shall be provided upon delivery of a new ship, and kept on board the ship and/or ashore and updated as appropriate throughout the ship's service. The contents of the Ship Construction File shall, at least, conform to the guidelines developed by the Organization.†

Regulation 3-11

Corrosion protection of cargo oil tanks of crude oil tankers

1 Paragraph 3 shall apply to crude oil tankers,‡ as defined in regulation 1 of Annex I to the International Convention for the Prevention of Pollution from Ships, 1973, as modified by the Protocol of 1978 relating thereto, of 5,000 tonnes deadweight and above:

- .1 for which the building contract is placed on or after 1 January 2013; or
- .2 in the absence of a building contract, the keels of which are laid or which are at a similar stage of construction on or after 1 July 2013; or
- .3 the delivery of which is on or after 1 January 2016.

2 Paragraph 3 shall not apply to combination carriers or chemical tankers as defined in regulations 1 of Annexes I and II, respectively, to the International Convention for the Prevention of Pollution from Ships, 1973, as modified by the Protocol of 1978 relating thereto. For the purpose of this regulation, chemical tankers also include chemical tankers certified to carry oil.

3 All cargo oil tanks of crude oil tankers shall be:

- .1 coated during the construction of the ship in accordance with the *Performance standard for protective coatings for cargo oil tanks of crude oil tankers*, adopted by the Maritime Safety Committee by resolution MSC.288(87), as may be amended by the Organization, provided that such amendments are adopted, brought into force and take effect in accordance with the provisions of article VIII of the present Convention concerning the amendment procedures applicable to the annex other than chapter I; or
- .2 protected by alternative means of corrosion protection or utilization of corrosion resistance material to maintain required structural integrity for 25 years in accordance with the *Performance standard for alternative means of corrosion protection for cargo oil tanks of crude oil tankers*, adopted by the Maritime Safety Committee by resolution MSC.289(87), as may be amended by the Organization, provided that such amendments are adopted, brought into force and take effect in accordance

* The *International goal-based ship construction standards for bulk carriers and oil tankers* were adopted by resolution MSC.287(87) and their verification should be carried out in accordance with the *Revised guidelines for verification of conformity with goal-based ship construction standards for bulk carriers and oil tankers* (resolution MSC.454(100)).

† Refer to *Guidelines for the information to be included in a Ship Construction File* (MSC.1/Circ.1343).

‡ Refer to items 1.11.1 or 1.11.4 of the Supplement to the International Oil Pollution Prevention Certificate (Form B).

with the provisions of article VIII of the present Convention concerning the amendment procedures applicable to the annex other than chapter I.

4 The Administration may exempt a crude oil tanker from the requirements of paragraph 3 to allow the use of novel prototype alternatives to the coating system specified in paragraph 3.1, for testing, provided they are subject to suitable controls, regular assessment and acknowledgement of the need for immediate remedial action if the system fails or is shown to be failing. Such exemption shall be recorded on an exemption certificate.

5 The Administration may exempt a crude oil tanker from the requirements of paragraph 3 if the ship is built to be engaged solely in the carriage of cargoes and cargo handling operations not causing corrosion.* Such exemption and conditions for which it is granted shall be recorded on an exemption certificate.

Regulation 3-12

Protection against noise

1 This regulation shall apply to ships of 1,600 gross tonnage and above:

- .1 for which the building contract is placed on or after 1 July 2014; or
- .2 in the absence of a building contract, the keels of which are laid or which are at a similar stage of construction on or after 1 January 2015; or
- .3 the delivery of which is on or after 1 July 2018,

unless the Administration deems that compliance with a particular provision is unreasonable or impractical.

2 On ships delivered before 1 July 2018 and:

- .1 contracted for construction before 1 July 2014 and the keels of which are laid or which are at a similar stage of construction on or after 1 January 2009; or
- .2 in the absence of a building contract, the keels of which are laid or which are at a similar stage of construction on or after 1 January 2009 but before 1 January 2015,

measures[†] shall be taken to reduce machinery noise in machinery spaces to acceptable levels as determined by the Administration[‡]. If this noise cannot be sufficiently reduced the source of excessive noise shall be suitably insulated or isolated or a refuge from noise shall be provided if the space is required to be manned. Ear protectors shall be provided for personnel required to enter such spaces, if necessary.

3 Ships shall be constructed to reduce onboard noise and to protect personnel from the noise in accordance with the Code on Noise Levels on Board Ships, adopted by the Maritime Safety Committee by resolution MSC.337(91), as may be amended by the Organization, provided that such amendments are adopted, brought into force and take effect in accordance with the provisions of article VIII of the present Convention concerning the amendment procedures applicable to the annex other than chapter I. For the purpose of this regulation, although the Code on Noise Levels on Board Ships is treated as a mandatory instrument, recommendatory parts as specified in chapter I of the Code shall be treated as non-mandatory, provided that amendments to such recommendatory parts are adopted by the Maritime Safety Committee in accordance with its Rules of Procedure.

4 Notwithstanding the requirements of paragraph 1, this regulation does not apply to types of ships listed in paragraph 1.3.4 of the Code on Noise Levels on Board Ships.

* Refer to *Guidelines on procedures for in-service maintenance and repair of coating systems for cargo oil tanks of crude oil tankers* (MSC.1/Circ.1399) and *Guidelines on exemptions for crude oil tankers solely engaged in the carriage of cargoes and cargo-handling operations not causing corrosion* (MSC.1/Circ.1421).

[†] Refer to the *Code on Noise Levels on Board Ships* (resolution A.468(XII)).

[‡] Refer to *Guidelines for the reduction of underwater noise from commercial shipping to address adverse impacts on marine life* (MEPC.1/Circ.833).

Part B

Subdivision and stability

SEE INTERPRETATION 19

Regulation 4

General

- 1 Unless expressly provided otherwise, the requirements in parts B-1 to B-4 shall apply to passenger ships.
- 2 For cargo ships, the requirements in parts B-1 to B-4 shall apply as follows:
 - .1 In part B-1:
 - .1 unless expressly provided otherwise, regulation 5 shall apply to cargo ships and regulation 5-1 shall apply to cargo ships other than tankers, as defined in regulation 1/2(h);
 - .2 regulation 6 to regulation 7-3 shall apply to cargo ships having a length (L) of 80 m and upwards, but may exclude those ships subject to the following instruments and shown to comply with the subdivision and damage stability requirements of that instrument:
 - .1 Annex I to MARPOL, except that combination carriers (as defined in SOLAS regulation II-2/3.14) with type B freeboards shall be in compliance with regulation 6 to regulation 7-3;* or
 - .2 the International Code for the Construction and Equipment of Ships Carrying Dangerous Chemicals in Bulk (IBC Code);* or
 - .3 the International Code for the Construction and Equipment of Ships Carrying Liquefied Gases in Bulk (IGC Code);* or
 - .4 the damage stability requirements of regulation 27 of the 1966 Load Lines Convention as applied in compliance with resolutions A.320(IX) and A.514(13), provided that in the case of cargo ships to which regulation 27(9) applies, main transverse watertight bulkheads, to be considered effective, are spaced according to paragraph (12)(f) of resolution A.320(IX), except that ships intended for the carriage of deck cargo shall be in compliance with regulation 6 to regulation 7-3; or
 - .5 the damage stability requirements of regulation 27 of the 1988 Load Lines Protocol, except that ships intended for the carriage of deck cargo shall be in compliance with regulation 6 to regulation 7-3; or
 - .6 the subdivision and damage stability standards in other instruments[†] developed by the Organization.
 - .2 Unless expressly provided otherwise, the requirements in parts B-2 and B-4 shall apply to cargo ships.
- 3 The Administration may, for a particular ship or group of ships, accept alternative methodologies if it is satisfied that at least the same degree of safety as represented by these regulations is achieved. Any

* Refer to *Guidelines for verification of damage stability requirements for tankers* (MSC.1/Circ.1461).

[†] .1 For offshore supply vessels of not more than 100 m in length (L), the *Guidelines for the design and construction of offshore supply vessels, 2006* (resolution MSC.235(82), as amended by resolution MSC.335(90)); or

.2 For special purpose ships, the *Code of Safety for Special Purpose Ships, 2008* (resolution MSC.266(84), as amended).

Administration which allows such alternative methodologies shall communicate to the Organization particulars thereof.

4 Ships shall be as efficiently subdivided as is possible having regard to the nature of the service for which they are intended. The degree of subdivision shall vary with the subdivision length (L_s) of the ship and with the service, in such manner that the highest degree of subdivision corresponds with the ships of greatest subdivision length (L_s), primarily engaged in the carriage of passengers.

5 Where it is proposed to fit decks, inner skins or longitudinal bulkheads of sufficient tightness to seriously restrict the flow of water, the Administration shall be satisfied that proper consideration is given to beneficial or adverse effects of such structures in the calculations.

Part B-1

Stability

Regulation 5

Intact stability

1 Every passenger ship, regardless of size, and every cargo ship having a length (L) of 24 m and upwards, shall be inclined upon its completion. The lightship displacement and the longitudinal, transverse and vertical position of its centre of gravity shall be determined. In addition to any other applicable requirements of the present regulations, ships having a length of 24 m and upwards shall as a minimum comply with the requirements of part A of the 2008 IS Code.

2 The Administration may allow the inclining test of an individual cargo ship to be dispensed with, provided basic stability data are available from the inclining test of a sister ship and it is shown to the satisfaction of the Administration that reliable stability information for the exempted ship can be obtained from such basic data, as required by regulation 5-1. A lightweight survey shall be carried out upon completion and the ship shall be inclined whenever, in comparison with the data derived from the sister ship, a deviation from the lightship displacement exceeding 1% for ships of 160 m or more in length and 2% for ships of 50 m or less in length and as determined by linear interpolation for intermediate lengths or a deviation from the lightship longitudinal centre of gravity exceeding 0.5% of L is found.

3 The Administration may also allow the inclining test of an individual ship or class of ships especially designed for the carriage of liquids or ore in bulk to be dispensed with when reference to existing data for similar ships clearly indicates that, due to the ship's proportions and arrangements, more than sufficient metacentric height will be available in all probable loading conditions.

4 Where any alterations are made to a ship so as to materially affect the stability information supplied to the master, amended stability information shall be provided. If necessary, the ship shall be re-inclined. The ship shall be re-inclined if anticipated deviations exceed one of the values specified in paragraph 5.

5 At periodical intervals not exceeding 5 years, a lightweight survey shall be carried out on all passenger ships to verify any changes in lightship displacement and longitudinal centre of gravity. The ship shall be re-inclined whenever, in comparison with the approved stability information, a deviation from the lightship displacement exceeding 2% or a deviation of the longitudinal centre of gravity exceeding 1% of L is found or anticipated.

6 Every ship shall have scales of draughts marked clearly at the bow and stern. In the case where the draught marks are not located where they are easily readable, or operational constraints for a particular trade make it difficult to read the draught marks, then the ship shall also be fitted with a reliable draught indicating system by which the bow and stern draughts can be determined.

Regulation 5-1

*Stability information to be supplied to the master**

1 The master shall be supplied with such information to the satisfaction of the Administration as is necessary to enable him by rapid and simple processes to obtain accurate guidance as to the stability of the ship under varying conditions of service. A copy of the stability information shall be furnished to the Administration.

* Refer also to the *Guidelines for the preparation of intact stability information* (MSC/Circ.456) and the *Revised guidance to the master for avoiding dangerous situations in adverse weather and sea conditions* (MSC.1/Circ.1228).

2 The information should include:

- .1 curves or tables of minimum operational metacentric height (GM) and maximum permissible trim versus draught which assures compliance with the intact and damage stability requirements where applicable, alternatively corresponding curves or tables of the maximum allowable vertical centre of gravity (KG) and maximum permissible trim versus draught, or with the equivalents of either of these curves or tables;
- .2 instructions concerning the operation of cross-flooding arrangements; and
- .3 all other data and aids which might be necessary to maintain the required intact stability and stability after damage.

3 The intact and damage stability information required by regulation 5-1.2 shall be presented as consolidated data and encompass the full operating range of draught and trim*. Applied trim values shall coincide in all stability information intended for use on board. Information not required for determination of stability and trim limits should be excluded from this information.

4 If the damage stability is calculated in accordance with regulation 6 to regulation 7-3 and, if applicable, with regulations 8 and 9.8, a stability limit curve is to be determined using linear interpolation between the minimum required GM assumed for each of the three draughts d_s , d_p and d_i . When additional subdivision indices are calculated for different trims, a single envelope curve based on the minimum values from these calculations shall be presented. When it is intended to develop curves of maximum permissible KG it shall be ensured that the resulting maximum KG curves correspond with a linear variation of GM.

5 As an alternative to a single envelope curve, the calculations for additional trims may be carried out with one common GM for all of the trims assumed at each subdivision draught. The lowest values of each partial index A_s , A_p and A_i across these trims shall then be used in the summation of the attained subdivision index A according to regulation 7.1. This will result in one GM limit curve based on the GM used at each draught. A trim limit diagram showing the assumed trim range shall be developed.

6 When curves or tables of minimum operational metacentric height (GM) or maximum allowable KG versus draught are not provided, the master shall ensure that the operating condition does not deviate from approved loading conditions, or verify by calculation that the stability requirements are satisfied for this loading condition.

Regulation 6

Required subdivision index R^\dagger

1 The subdivision of a ship is considered sufficient if the attained subdivision index A , determined in accordance with regulation 7, is not less than the required subdivision index R calculated in accordance with this regulation and if, in addition, the partial indices A_s , A_p and A_i are not less than $0.9R$ for passenger ships and $0.5R$ for cargo ships.

2 For ships to which the damage stability requirements of this part apply, the degree of subdivision to be provided shall be determined by the required subdivision index R , as follows:

- .1 In the case of cargo ships greater than 100 m in length (L_s):

$$R = 1 - \frac{128}{L_s + 152}$$

* Refer to *Guidelines for verification of damage stability requirements for tankers* (MSC.1/Circ.1461).

† The Maritime Safety Committee, in adopting the regulations contained in parts B to B-4, invited Administrations to note that the regulations should be applied in conjunction with the explanatory notes developed by the Organization in order to ensure their uniform application.

- .2 In the case of cargo ships not less than 80 m in length (L_s) and not greater than 100 m in length (L_g):

$$R = 1 - \frac{1}{1 + \frac{L_s}{100} \times \frac{R_o}{1 - R_o}}$$

where R_o is the value R as calculated in accordance with the formula in subparagraph .1.

- .3 In the case of passenger ships:

Persons on board	R
$N < 400$	$R = 0.722$
$400 \leq N \leq 1,350$	$R = \frac{N}{7,580} + 0.66923$
$1,350 < N \leq 6,000$	$R = 0.0369 \times \ln(N + 89.048) + 0.579$
$N > 6,000$	$R = 1 - \frac{852.5 + 0.03875 \times N}{N + 5,000}$

where:

N = total number of persons on board.

Regulation 7

Attained subdivision index A

1 An attained subdivision index A is obtained by the summation of the partial indices A_s , A_p and A_l , (weighted as shown and calculated for the draughts d_s , d_p and d_l defined in regulation 2 in accordance with the following formula:

$$A = 0.4A_s + 0.4A_p + 0.2A_l$$

Each partial index is a summation of contributions from all damage cases taken in consideration, using the following formula:

$$A = \sum p_i s_i$$

Where:

i represents each compartment or group of compartments under consideration,

p_i accounts for the probability that only the compartment or group of compartments under consideration may be flooded, disregarding any horizontal subdivision, as defined in regulation 7-1,

s_i accounts for the probability of survival after flooding the compartment or group of compartments under consideration, and includes the effect of any horizontal subdivision, as defined in regulation 7-2.

2 As a minimum, the calculation of A shall be carried out at the level trim for the deepest subdivision draught d_s and the partial subdivision draught d_p . The estimated service trim may be used for the light service draught d_l . If, in any anticipated service condition within the draught range from d_s to d_l , the trim variation in comparison with the calculated trims is greater than 0.5% of L , one or more additional calculations of A are to be performed for the same draughts but including sufficient trims to ensure that, for all intended service conditions, the difference in trim in comparison with the reference trim used for one calculation will be not more than 0.5% of L . Each additional calculation of A shall comply with regulation 6.1.

3 When determining the positive righting lever (GZ) of the residual stability curve in the intermediate and final equilibrium stages of flooding, the displacement used should be that of the intact loading condition. All calculations should be done with the ship freely trimming.

4 The summation indicated by the above formula shall be taken over the ship's subdivision length (L_s) for all cases of flooding in which a single compartment or two or more adjacent compartments are involved.

In the case of unsymmetrical arrangements, the calculated A value should be the mean value obtained from calculations involving both sides. Alternatively, it should be taken as that corresponding to the side which evidently gives the least favourable result.

5 Wherever wing compartments are fitted, contribution to the summation indicated by the formula shall be taken for all cases of flooding in which wing compartments are involved. Additionally, cases of simultaneous flooding of a wing compartment or group of compartments and the adjacent inboard compartment or group of compartments, but excluding damage of transverse extent greater than one half of the ship breadth B , may be added. For the purpose of this regulation, transverse extent is measured inboard from ship's side, at right angle to the centreline at the level of the deepest subdivision draught.

6 In the flooding calculations carried out according to the regulations, only one breach of the hull and only one free surface need to be assumed. The assumed vertical extent of damage is to extend from the baseline upwards to any watertight horizontal subdivision above the waterline or higher. However, if a lesser extent of damage will give a more severe result, such extent is to be assumed.

7 If pipes, ducts or tunnels are situated within the assumed extent of damage, arrangements are to be made to ensure that progressive flooding cannot thereby extend to compartments other than those assumed flooded. However, the Administration may permit minor progressive flooding if it is demonstrated that its effects can be easily controlled and the safety of the ship is not impaired.

Regulation 7-1

Calculation of the factor p_i

1 The factor p_i for a compartment or group of compartments shall be calculated in accordance with paragraphs 1.1 and 1.2 using the following notations:

- j = the aftmost damage zone number involved in the damage starting with No. 1 at the stern;
- n = the number of adjacent damage zones involved in the damage;
- k = the number of a particular longitudinal bulkhead as barrier for transverse penetration in a damage zone counted from shell towards the centreline. The shell has $k = 0$;
- x_1 = the distance from the aft terminal of L_s to the aft end of the zone in question;
- x_2 = the distance from the aft terminal of L_s to the forward end of the zone in question;
- b = the mean transverse distance in metres measured at right angles to the centreline at the deepest subdivision draught between the shell and an assumed vertical plane extended between the longitudinal limits used in calculating the factor p_i and which is a tangent to, or common with, all or part of the outermost portion of the longitudinal bulkhead under consideration. This vertical plane shall be so orientated that the mean transverse distance to the shell is a maximum, but not more than twice the least distance between the plane and the shell. If the upper part of a longitudinal bulkhead is below the deepest subdivision draught the vertical plane used for determination of b is assumed to extend upwards to the deepest subdivision waterline. In any case, b is not to be taken greater than $B/2$.

If the damage involves a single zone only:

$$p_i = p(x_1, x_2) \cdot [r(x_1, x_2, b_k) - r(x_1, x_2, b_{k-1})]$$

If the damage involves two adjacent zones:

$$p_i = p(x_1, x_2) \cdot [r(x_1, x_2, b_k) - r(x_1, x_2, b_{k-1})] - p(x_1, x_2) \cdot [r(x_1, x_2, b_k) - r(x_1, x_2, b_{k-1})]$$

If the damage involves three or more adjacent zones:

$$p_i = p(x1_j, x2_{j+n-1}) \cdot [r(x1_j, x2_{j+n-1}, b_k) - r(x1_j, x2_{j+n-1}, b_{k-1})] - p(x1_j, x2_{j+n-2}) \cdot [r(x1_j, x2_{j+n-2}, b_k) - r(x1_j, x2_{j+n-2}, b_{k-1})] - p(x1_{j+1}, x2_{j+n-1}) \cdot [r(x1_{j+1}, x2_{j+n-1}, b_k) - r(x1_{j+1}, x2_{j+n-1}, b_{k-1})] + p(x1_{j+1}, x2_{j+n-2}) \cdot [r(x1_{j+1}, x2_{j+n-2}, b_k) - r(x1_{j+1}, x2_{j+n-2}, b_{k-1})]$$

and where $r(x1, x2, b_0) = 0$.

1.1 The factor $p(x1, x2)$ is to be calculated according to the following formulae:

Overall normalized max damage length:	$J_{\max} = 10/33$
Knuckle point in the distribution:	$J_{\text{kn}} = 5/33$
Cumulative probability at J_{kn} :	$p_k = 11/12$
Maximum absolute damage length:	$l_{\max} = 60 \text{ m}$
Length where normalized distribution ends:	$L^* = 260 \text{ m}$
Probability density at $J = 0$:	

$$b_0 = 2 \left(\frac{p_k}{J_{\text{kn}}} - \frac{1 - p_k}{J_{\max} - J_{\text{kn}}} \right)$$

When $L_s \leq L^*$:

$$J_m = \min \left(J_{\max}, \frac{l_{\max}}{L_s} \right)$$

$$J_k = \frac{J_m}{2} + \frac{1 - \sqrt{1 + (1 - 2p_k)b_0 J_m + \frac{1}{4}b_0^2 J_m^2}}{b_0}$$

$$b_{12} = b_0$$

When $L_s > L^*$:

$$J_m^* = \min \left(J_{\max}, \frac{l_{\max}}{L^*} \right)$$

$$J_k^* = \frac{J_m^*}{2} + \frac{1 - \sqrt{1 + (1 - 2p_k)b_0 J_m^* + \frac{1}{4}b_0^2 J_m^{*2}}}{b_0}$$

$$J_m = \frac{J_m^* \cdot L^*}{L_s}$$

$$J_k = \frac{J_k^* \cdot L^*}{L_s}$$

$$b_{12} = 2 \left(\frac{p_k}{J_k} - \frac{1 - p_k}{J_m - J_k} \right)$$

$$b_{11} = 4 \frac{1 - p_k}{(J_m - J_k)J_k} - 2 \frac{p_k}{J_k^2}$$

$$b_{21} = -2 \frac{1 - p_k}{(J_m - J_k)^2}$$

$$b_{22} = -b_{21}J_m$$

The non-dimensional damage length:

$$J = \frac{(x2 - x1)}{L_s}$$

The normalized length of a compartment or group of compartments:

J_n is to be taken as the lesser of J and J_m

1.1.1 Where neither limit of the compartment or group of compartments under consideration coincides with the aft or forward terminals:

$$J \leq J_k:$$

$$p(x_1, x_2) = p_1 = \frac{1}{6} J^2 (b_{11} J + 3b_{12})$$

$$J > J_k:$$

$$p(x_1, x_2) = p_2 = -\frac{1}{3} b_{11} J_k^3 + \frac{1}{2} (b_{11} J - b_{12}) J_k^2 + b_{12} J J_k - \frac{1}{3} b_{21} (J_n^3 - J_k^3) + \frac{1}{2} (b_{21} J - b_{22}) (J_n^2 - J_k^2) + b_{22} J (J_n - J_k)$$

1.1.2 Where the aft limit of the compartment or group of compartments under consideration coincides with the aft terminal or the forward limit of the compartment or group of compartments under consideration coincides with the forward terminal:

$$J \leq J_k:$$

$$p(x_1, x_2) = \frac{1}{2} (p_1 + J)$$

$$J > J_k:$$

$$p(x_1, x_2) = \frac{1}{2} (p_2 + J)$$

1.1.3 Where the compartment or groups of compartments considered extends over the entire subdivision length (L_s):

$$p(x_1, x_2) = 1$$

1.2 The factor $r(x_1, x_2, b)$ shall be determined by the following formulae:

$$r(x_1, x_2, b) = 1 - (1 - C) \cdot \left(1 - \frac{C}{p(x_1, x_2)} \right)$$

where:

$$C = 12 \cdot J_b \cdot (-45 \cdot J_b + 4), \text{ where}$$

$$J_b = \frac{b}{15 \cdot B}$$

1.2.1 Where the compartment or groups of compartments considered extends over the entire subdivision length (L_s):

$$G = G_1 = \frac{1}{2} b_{11} J_b^2 + b_{12} J_b$$

1.2.2 Where neither limit of the compartment or group of compartments under consideration coincides with the aft or forward terminals:

$$G = G_2 = -\frac{1}{3} b_{11} J_0^3 + \frac{1}{2} (b_{11} J - b_{12}) J_0^2 + b_{12} J J_0, \text{ where}$$

$$J_0 = \min(J, J_b)$$

1.2.3 Where the aft limit of the compartment or group of compartments under consideration coincides with the aft terminal or the forward limit of the compartment or group of compartments under consideration coincides with the forward terminal:

$$G = \frac{1}{2} (G_2 + G_1 \cdot J)$$

Regulation 7-2

Calculation of the factor s_i

SEE INTERPRETATION 20

1 The factor s_i shall be determined for each case of assumed flooding, involving a compartment or group of compartments, in accordance with the following notations and the provisions in this regulation.

θ_e is the equilibrium heel angle in any stage of flooding, in degrees;

θ_v is the angle, in any stage of flooding, where the righting lever becomes negative, or the angle at which an opening incapable of being closed weathertight becomes submerged;

GZ_{\max} is the maximum positive righting lever, in metres, up to the angle θ_v ;

Range is the range of positive righting levers, in degrees, measured from the angle θ_e . The positive range is to be taken up to the angle θ_v ;

Flooding stage is any discrete step during the flooding process, including the stage before equalization (if any), until final equilibrium has been reached.

1.1 The factor s_i , for any damage case at any initial loading condition, d_i , shall be obtained from the formula:

$$s_i = \text{minimum} (s_{\text{intermediate},i} \text{ OR } s_{\text{final},i} \cdot s_{\text{mom},i})$$

where:

$s_{\text{intermediate},i}$ is the probability to survive all intermediate flooding stages until the final equilibrium stage, and is calculated in accordance with paragraph 2;

$s_{\text{final},i}$ is the probability to survive in the final equilibrium stage of flooding. It is calculated in accordance with paragraph 3;

$s_{\text{mom},i}$ is the probability to survive heeling moments, and is calculated in accordance with paragraph 4.

2 For passenger ships, and cargo ships fitted with cross-flooding devices, the factor $s_{\text{intermediate},i}$ is taken as the least of the s -factors obtained from all flooding stages including the stage before equalization, if any, and is to be calculated as follows:

$$s_{\text{intermediate},i} = \left(\frac{GZ_{\max}}{0.05} \cdot \frac{Range}{7} \right)^{\frac{1}{4}}$$

where GZ_{\max} is not to be taken as more than 0.05 m and *Range* as not more than $7^\circ \cdot s_{\text{intermediate},i} = 0$, if the intermediate heel angle exceeds 15° for passenger ships and 30° for cargo ships.

For cargo ships not fitted with cross-flooding devices the factor $s_{\text{intermediate},i}$ is taken as unity, except if the Administration considers that the stability in intermediate stages of flooding may be insufficient, it should require further investigation thereof.

For passenger and cargo ships, where cross-flooding devices are fitted, the time for equalization shall not exceed 10 min.

3 The factor $s_{\text{final},i}$ shall be obtained from the formula:

$$s_{\text{final},i} = K \cdot \left(\frac{GZ_{\max}}{TGZ_{\max}} \cdot \frac{Range}{TRange} \right)^{\frac{1}{4}}$$

where:

GZ_{\max} is not to be taken as more than TGZ_{\max} ;

Range is not to be taken as more than *TRange*;

$TGZ_{\max} = 0.20$ m, for ro-ro passenger ships each damage case that involves a ro-ro space,

$TGZ_{\max} = 0.12$ m, otherwise;

TRange = 20° , for ro-ro passenger ships each damage case that involves a ro-ro space,

TRange = 16° , otherwise;

$K = 1$ if $\theta_e \leq \theta_{\min}$

$K = 0$ if $\theta_e \geq \theta_{\max}$

$$K = \sqrt{\frac{\theta_{\max} - \theta_e}{\theta_{\max} - \theta_{\min}}} \text{ otherwise,}$$

where:

θ_{\min} is 7° for passenger ships and 25° for cargo ships; and

θ_{\max} is 15° for passenger ships and 30° for cargo ships.

4 The factor $s_{\text{mom},i}$ is applicable only to passenger ships (for cargo ships $s_{\text{mom},i}$ shall be taken as unity) and shall be calculated at the final equilibrium from the formula:

$$s_{\text{mom},i} = \frac{(GZ_{\max} - 0.04) \cdot \text{Displacement}}{M_{\text{heel}}}$$

where:

Displacement is the intact displacement at the respective draught (d_s , d_p or d_i);

M_{heel} is the maximum assumed heeling moment as calculated in accordance with sub-paragraph 4.1; and

$$s_{\text{mom},i} \leq 1$$

4.1 The heeling moment M_{heel} is to be calculated as follows:

$$M_{\text{heel}} = \text{maximum} (M_{\text{passenger}} \text{ or } M_{\text{wind}} \text{ or } M_{\text{survivalcraft}})$$

4.1.1 $M_{\text{passenger}}$ is the maximum assumed heeling moment resulting from movement of passengers, and is to be obtained as follows:

$$M_{\text{passenger}} = (0.075 \cdot N_p) \cdot (0.45 \cdot B) \quad (\text{t} \cdot \text{m})$$

where:

N_p is the maximum number of passengers permitted to be on board in the service condition corresponding to the deepest subdivision draught under consideration; and

B is the breadth of the ship as defined in regulation 2.8.

Alternatively, the heeling moment may be calculated assuming the passengers are distributed with 4 persons per square metre on available deck areas towards one side of the ship on the decks where muster stations are located and in such a way that they produce the most adverse heeling moment. In doing so, a weight of 75 kg per passenger is to be assumed.

4.1.2 M_{wind} is the maximum assumed wind moment acting in a damage situation:

$$M_{\text{wind}} = \frac{(P \cdot A \cdot Z)}{9,806} \quad (\text{t} \cdot \text{m})$$

where:

$$P = 120 \text{ N/m}^2;$$

A = projected lateral area above waterline;

Z = distance from centre of lateral projected area above waterline to $T/2$; and

T = respective draught (d_s , d_p or d_i).

4.1.3 $M_{\text{survivalcraft}}$ is the maximum assumed heeling moment due to the launching of all fully loaded davit-launched survival craft on one side of the ship. It shall be calculated using the following assumptions:

- 1** all lifeboats and rescue boats fitted on the side to which the ship has heeled after having sustained damage shall be assumed to be swung out fully loaded and ready for lowering;

- .2 for lifeboats which are arranged to be launched fully loaded from the stowed position, the maximum heeling moment during launching shall be taken;
- .3 a fully loaded davit-launched liferaft attached to each davit on the side to which the ship has heeled after having sustained damage shall be assumed to be swung out ready for lowering;
- .4 persons not in the life-saving appliances which are swung out shall not provide either additional heeling or righting moment; and
- .5 life-saving appliances on the side of the ship opposite to the side to which the ship has heeled shall be assumed to be in a stowed position.

5 Unsymmetrical flooding is to be kept to a minimum consistent with the efficient arrangements. Where it is necessary to correct large angles of heel, the means adopted shall, where practicable, be self-acting, but in any case where controls to equalization devices are provided they shall be operable from above the bulkhead deck of passenger ships and the freeboard deck of cargo ships. These fittings together with their controls shall be acceptable to the Administration.* Suitable information concerning the use of equalization devices shall be supplied to the master of the ship.

5.1 Tanks and compartments taking part in such equalization shall be fitted with air pipes or equivalent means of sufficient cross-section to ensure that the flow of water into the equalization compartments is not delayed.

5.2 The factor s_i is to be taken as zero in those cases where the final waterline, taking into account sinkage, heel and trim, immerses:

- .1 the lower edge of openings through which progressive flooding may take place and such flooding is not accounted for in the calculation of factor s_i . Such openings shall include air pipes, ventilators and openings which are closed by means of weathertight doors or hatch covers; and
- .2 any part of the bulkhead deck in passenger ships considered a horizontal evacuation route for compliance with chapter II-2.

5.3 The factor s_i is to be taken as zero if, taking into account sinkage, heel and trim, any of the following occur in any intermediate stage or in the final stage of flooding:

- .1 immersion of any vertical escape hatch in the bulkhead deck of passenger ships and the freeboard deck of cargo ships intended for compliance with chapter II-2;
- .2 any controls intended for the operation of watertight doors, equalization devices, valves on piping or on ventilation ducts intended to maintain the integrity of watertight bulkheads from above the bulkhead deck of passenger ships and the freeboard deck of cargo ships become inaccessible or inoperable; and
- .3 immersion of any part of piping or ventilation ducts located within the assumed extent of damage and carried through a watertight boundary if this can lead to the progressive flooding of compartments not assumed as flooded.

5.4 However, where compartments assumed flooded due to progressive flooding are taken into account in the damage stability calculations, multiple values of $s_{i, \text{intermediate}, j}$ may be calculated, assuming equalization in additional flooding phases.

* Reference is made to the *Revised recommendation on a standard method for evaluating cross-flooding arrangements*, adopted by the Organization by resolution MSC.362(92), as may be amended.

5.5 Except as provided in paragraph 5.3.1, openings closed by means of watertight manhole covers and flush scuttles, remotely operated sliding watertight doors, sidescuttles of the non-opening type as well as watertight access doors and watertight hatch covers required to be kept closed at sea need not be considered.

6 Where horizontal watertight boundaries are fitted above the waterline under consideration, the s -value calculated for the lower compartment or group of compartments shall be obtained by multiplying the value as determined in paragraph 1.1 by the reduction factor v_m according to paragraph 6.1, which represents the probability that the spaces above the horizontal subdivision will not be flooded.

6.1 The factor v_m shall be obtained from the formula:

$$v_m = v(H_{j,n,m}, d) - v(H_{j,n,m-1}, d)$$

where:

$H_{j,n,m}$ is the least height above the baseline, in metres, within the longitudinal range of $x_{1(j)} \dots x_{2(j+n-1)}$ of the m^{th} horizontal boundary which is assumed to limit the vertical extent of flooding for the damaged compartments under consideration;

$H_{j,n,m-1}$ is the least height above the baseline, in metres, within the longitudinal range of $x_{1(j)} \dots x_{2(j+n-1)}$ of the $(m-1)^{\text{th}}$ horizontal boundary which is assumed to limit the vertical extent of flooding for the damaged compartments under consideration;

j signifies the aft terminal of the damaged compartments under consideration;

m represents each horizontal boundary counted upwards from the waterline under consideration;

d is the draught in question as defined in regulation 2; and

x_1 and x_2 represent the terminals of the compartment or group of compartments considered in regulation 7-1.

6.1.1 The factors $v(H_{j,n,m}, d)$ and $v(H_{j,n,m-1}, d)$ shall be obtained from the formulae:

$$v(H, d) = 0.8 \frac{(H-d)}{7.8}, \text{ if } (H-d) \text{ is less than, or equal to, } 7.8 \text{ m;}$$

$$v(H, d) = 0.8 + 0.2 \left(\frac{(H-d) - 7.8}{4.7} \right) \text{ in all other cases,}$$

where

$v(H_{j,n,m}, d)$ is to be taken as 1, if H_m coincides with the uppermost watertight boundary of the ship within the range $(x_{1(j)} \dots x_{2(j+n-1)})$, and

$v(H_{j,n,0}, d)$ is to be taken as 0.

In no case is v_m to be taken as less than zero or more than 1.

6.2 In general, each contribution dA to the index A in the case of horizontal subdivisions is obtained from the formula:

$$dA = p_j \cdot [v_1 \cdot s_{\min 1} + (v_2 - v_1) \cdot s_{\min 2} + \dots + (1 - v_{m-1}) \cdot s_{\min m}]$$

where:

v_m = the v -value calculated in accordance with paragraph 6.1;

s_{\min} = the least s -factor for all combinations of damages obtained when the assumed damage extends from the assumed damage height H_m downwards.

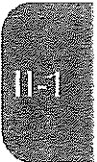

Regulation 7-3 Permeability

1 For the purpose of the subdivision and damage stability calculations of the regulations, the permeability of each general compartment or part of a compartment shall be as follows:

Spaces	Permeability
Appropriated to stores	0.60
Occupied by accommodation	0.95
Occupied by machinery	0.85
Void spaces	0.95
Intended for liquids	0 or 0.95*

2 For the purpose of the subdivision and damage stability calculations of the regulations, the permeability of each cargo compartment or part of a compartment shall be as follows:

Spaces	Permeability at draught d_s	Permeability at draught d_p	Permeability at draught d_l
Dry cargo spaces	0.70	0.80	0.95
Container spaces	0.70	0.80	0.95
Ro-ro spaces	0.90	0.90	0.95
Cargo liquids	0.70	0.80	0.95

3 Other figures for permeability may be used if substantiated by calculations.

Regulation 8 Special requirements concerning passenger ship stability

1 A passenger ship intended to carry 400 or more persons shall have watertight subdivision abaft the collision bulkhead so that $s_i = 1$ for a damage involving all the compartments within $0.08L$ measured from the forward perpendicular for the three loading conditions used to calculate the attained subdivision index A . If the attained subdivision index A is calculated for different trims, this requirement shall also be satisfied for those loading conditions.

2 A passenger ship intended to carry 36 or more persons is to be capable of withstanding damage along the side shell to an extent specified in paragraph 3. Compliance with this regulation is to be achieved by demonstrating that s_{ii} , as defined in regulation 7-2, is not less than 0.9 for the three loading conditions used to calculate the attained subdivision index A . If the attained subdivision index A is calculated for different trims, this requirement shall also be satisfied for those loading conditions.

3 The damage extent[†] to be assumed when demonstrating compliance with paragraph 2 is to be dependent on the total number of persons carried, and L , such that:

- .1 the vertical extent of damage is to extend from the ship's moulded baseline to a position up to 12.5 m above the position of the deepest subdivision draught as defined in regulation 2, unless a lesser vertical extent of damage were to give a lower value of s_{ii} , in which case this reduced extent is to be used;

* Whichever results in the more severe requirement.

† Refer to the appendix of the *Revised guidance for watertight doors on passenger ships which may be opened during navigation* (MSC.1/Circ.1564).

- .2 where 400 or more persons are to be carried, a damage length of $0.03L$, but not less than 3 m is to be assumed at any position along the side shell, in conjunction with a penetration inboard of $0.1B$ but not less than 0.75 m measured inboard from the ship side, at right angles to the centreline at the level of the deepest subdivision draught;
- .3 where fewer than 400 persons are carried, damage length is to be assumed at any position along the shell side between transverse watertight bulkheads provided that the distance between two adjacent transverse watertight bulkheads is not less than the assumed damage length. If the distance between adjacent transverse watertight bulkheads is less than the assumed damage length, only one of these bulkheads shall be considered effective for the purpose of demonstrating compliance with paragraph 2;
- .4 where 36 persons are carried, a damage length of $0.015L$ but not less than 3 m is to be assumed, in conjunction with a penetration inboard of $0.05B$ but not less than 0.75 m; and
- .5 where more than 36, but fewer than 400, persons are carried, the values of damage length and penetration inboard, used in the determination of the assumed extent of damage, are to be obtained by linear interpolation between the values of damage length and penetration which apply for ships carrying 36 persons and 400 persons as specified in subparagraphs .4 and .2.

Regulation 8-1

System capabilities and operational information after a flooding casualty on passenger ships

1 Application

Passenger ships having length, as defined in regulation II-1/2.5, of 120 m or more or having three or more main vertical zones shall comply with the provisions of this regulation.

2 Availability of essential systems in case of flooding damage*

A passenger ship shall be designed so that the systems specified in regulation II-2/21.4 remain operational when the ship is subject to flooding of any single watertight compartment.

3 Operational information after a flooding casualty

3.1 For the purpose of providing operational information to the master for safe return to port after a flooding casualty, passenger ships, as specified in paragraph 1, shall have:

- .1 an onboard stability computer; or
- .2 shore-based support,

based on the guidelines developed by the Organization.†

3.2 Passenger ships constructed before 1 January 2014 shall comply with the provisions in paragraph 3.1 not later than the first renewal survey after 1 January 2025.

* Refer to the *Interim Explanatory Notes for the assessment of passenger ship systems' capabilities after a fire or flooding casualty* (MSC.1/Circ.1369 and MSC.1/Circ.1369/Add.1).

† Refer to the *Guidelines on operational information for masters of passenger ships for safe return to port by own power or under tow* (MSC.1/Circ.1400) for ships constructed on or after 1 January 2014 but before 13 May 2016, or the *Revised guidelines on operational information for masters of passenger ships for safe return to port* (MSC.1/Circ.1532/Rev.1) for ships constructed on or after 13 May 2016, or the *Guidelines on operational information for masters in case of flooding* for passenger ships constructed before 1 January 2014 (MSC.1/Circ.1589).

Part B-2

Subdivision, watertight and weathertight integrity

Regulation 9

Double bottoms in passenger ships and cargo ships other than tankers

1 A double bottom shall be fitted extending from the collision bulkhead to the afterpeak bulkhead, as far as this is practicable and compatible with the design and proper working of the ship.

2 Where a double bottom is required to be fitted, the inner bottom shall be continued out to the ship's sides in such a manner as to protect the bottom to the turn of the bilge. Such protection will be deemed satisfactory if the inner bottom is not lower at any part than a plane parallel with the keel line and which is located not less than a vertical distance h measured from the keel line, as calculated by the formula:

$$h = B/20$$

However, in no case is the value of h to be less than 760 mm, and need not be taken as more than 2,000 mm.

3.1 Small wells constructed in the double bottom in connection with drainage arrangements shall not extend downward more than necessary. The vertical distance from the bottom of such a well to a plane coinciding with the keel line shall not be less than $h/2$ or 500 mm, whichever is greater, or compliance with paragraph 8 of this regulation shall be shown for that part of the ship.

3.2 Other wells (e.g. for lubricating oil under main engines) may be permitted by the Administration if satisfied that the arrangements give protection equivalent to that afforded by a double bottom complying with this regulation.

3.2.1 For a cargo ship of 80 m in length and upwards or for a passenger ship, proof of equivalent protection is to be shown by demonstrating that the ship is capable of withstanding bottom damages as specified in paragraph 8. Alternatively, wells for lubricating oil below main engines may protrude into the double bottom below the boundary line defined by the distance h provided that the vertical distance between the well bottom and a plane coinciding with the keel line is not less than $h/2$ or 500 mm, whichever is greater.

3.2.2 For cargo ships of less than 80 m in length the arrangements shall provide a level of safety to the satisfaction of the Administration.

4 A double bottom need not be fitted in way of watertight tanks, including dry tanks of moderate size, provided the safety of the ship is not impaired in the event of bottom or side damage.

5 In the case of passenger ships to which the provisions of regulation 1.5 apply and which are engaged on regular service within the limits of a short international voyage as defined in regulation III/3.22, the Administration may permit a double bottom to be dispensed with if satisfied that the fitting of a double bottom in that part would not be compatible with the design and proper working of the ship.

6 Any part of a cargo ship of 80 m in length and upwards or of a passenger ship that is not fitted with a double bottom in accordance with paragraphs 1, 4 or 5, as specified in paragraph 2, shall be capable of withstanding bottom damages, as specified in paragraph 8, in that part of the ship. For cargo ships of less than 80 m in length the alternative arrangements shall provide a level of safety to the satisfaction of the Administration.

7 In the case of unusual bottom arrangements in a cargo ship of 80 m in length and upwards or a passenger ship, it shall be demonstrated that the ship is capable of withstanding bottom damages as specified in paragraph 8. For cargo ships of less than 80 m in length the alternative arrangements shall provide a level of safety to the satisfaction of the Administration.

8 Compliance with paragraphs 3.1, 3.2.1, 6 or 7 is to be achieved by demonstrating that s_b , when calculated in accordance with regulation 7-2, is not less than 1 for all service conditions when subject to bottom damage with an extent specified in sub-paragraph .2 below for any position in the affected part of the ship:

- .1 Flooding of such spaces shall not render emergency power and lighting, internal communication, signals or other emergency devices inoperable in other parts of the ship.
- .2 Assumed extent of damage shall be as follows:

	For 0.3L from the forward perpendicular of the ship	Any other part of the ship
Longitudinal extent	$1/3L^{2/3}$ or 14.5 m, whichever is less	$1/3L^{2/3}$ or 14.5 m, whichever is less
Transverse extent	$B/6$ or 10 m, whichever is less	$B/6$ or 5 m, whichever is less
Vertical extent, measured from the keel line	$B/20$, to be taken not less than 0.76 m and not more than 2 m	$B/20$, to be taken not less than 0.76 m and not more than 2 m

- .3 If any damage of a lesser extent than the maximum damage specified in .2 would result in a more severe condition, such damage should be considered.

9 In case of large lower holds in passenger ships, the Administration may require an increased double-bottom height of not more than $B/10$ or 3 m, whichever is less, measured from the keel line. Alternatively, bottom damages may be calculated for these areas, in accordance with paragraph 8, but assuming an increased vertical extent.

Regulation 10

Construction of watertight bulkheads

1 Each watertight subdivision bulkhead, whether transverse or longitudinal, shall be constructed having scantlings as specified in regulation 2.17. In all cases, watertight subdivision bulkheads shall be capable of supporting at least the pressure due to a head of water up to the bulkhead deck of passenger ships and the freeboard deck of cargo ships.

2 Steps and recesses in watertight bulkheads shall be as strong as the bulkhead at the place where each occurs.

Regulation 11

Initial testing of watertight bulkheads, etc.

1 Testing watertight spaces not intended to hold liquids and cargo holds intended to hold ballast by filling them with water is not compulsory. When testing by filling with water is not carried out, a hose test shall be carried out where practicable. This test shall be carried out in the most advanced stage of the fitting out of the ship. Where a hose test is not practicable because of possible damage to machinery, electrical equipment insulation or outfitting items, it may be replaced by a careful visual examination of welded connections, supported where deemed necessary by means such as a dye penetrant test or an ultrasonic leak test or an equivalent test. In any case a thorough inspection of the watertight bulkheads shall be carried out.

2 The forepeak, double bottom (including duct keels) and inner skins shall be tested with water to a head corresponding to the requirements of regulation 10.1.

3 Tanks which are intended to hold liquids, and which form part of the watertight subdivision of the ship, shall be tested for tightness and structural strength with water to a head corresponding to its design pressure.

The water head is in no case to be less than the top of the air pipes or to a level of 2.4 m above the top of the tank, whichever is the greater.

4 The tests referred to in paragraphs 2 and 3 are for the purpose of ensuring that the subdivision structural arrangements are watertight and are not to be regarded as a test of the fitness of any compartment for the storage of oil fuel or for other special purposes for which a test of a superior character may be required, depending on the height to which the liquid has access in the tank or its connections.

Regulation 12

Peak and machinery space bulkheads, shaft tunnels, etc.

1 A collision bulkhead shall be fitted which shall be watertight up to the bulkhead deck of passenger ships and the freeboard deck of cargo ships. This bulkhead shall be located at a distance from the forward perpendicular of not less than $0.05L$ or 10 m, whichever is less, and, except as may be permitted by the Administration, not more than $0.08L$ or $0.05L + 3$ m, whichever is the greater.

2 The ship shall be so designed that s_f calculated in accordance with regulation 7-2 will not be less than 1 at the deepest subdivision draught loading condition, level trim or any forward trim loading conditions, if any part of the ship forward of the collision bulkhead is flooded without vertical limits.

3 Where any part of the ship below the waterline extends forward of the forward perpendicular, e.g. a bulbous bow, the distances stipulated in paragraph 1 shall be measured from a point either:

- .1 at the mid-length of such extension;
- .2 at a distance $0.015L$ forward of the forward perpendicular; or
- .3 at a distance 3 m forward of the forward perpendicular,

whichever gives the smallest measurement.

4 The bulkhead may have steps or recesses provided they are within the limits prescribed in paragraph 1 or 3.

5 No doors, manholes, access openings, ventilation ducts or any other openings shall be fitted in the collision bulkhead below the bulkhead deck of passenger ships and the freeboard deck of cargo ships.

6.1 Except as provided in paragraph 6.2, the collision bulkhead may be pierced below the bulkhead deck of passenger ships and the freeboard deck of cargo ships by not more than one pipe for dealing with fluid in the forepeak tank, provided that the pipe is fitted with a screw-down valve capable of being operated from above the bulkhead deck of passenger ships and the freeboard deck of cargo ships, the valve being located inside the forepeak at the collision bulkhead. The Administration may, however, authorize the fitting of this valve on the after side of the collision bulkhead provided that the valve is readily accessible under all service conditions and the space in which it is located is not a cargo space. Alternatively, for cargo ships, the pipe may be fitted with a butterfly valve suitably supported by a seat or flanges and capable of being operated from above the freeboard deck. All valves shall be of steel, bronze or other approved ductile material. Valves of ordinary cast iron or similar material are not acceptable.

6.2 If the forepeak is divided to hold two different kinds of liquids, the Administration may allow the collision bulkhead to be pierced below the bulkhead deck of passenger ships and the freeboard deck of cargo ships by two pipes, each of which is fitted as required by paragraph 6.1, provided the Administration is satisfied that there is no practical alternative to the fitting of such a second pipe and that, having regard to the additional subdivision provided in the forepeak, the safety of the ship is maintained.

7 Where a long forward superstructure is fitted, the collision bulkhead shall be extended weathertight to the deck next above the bulkhead deck of passenger ships and the freeboard deck of cargo ships. The extension need not be fitted directly above the bulkhead below provided that all parts of the extension, including any part of the ramp attached to it, are located within the limits prescribed in paragraph 1 or 3, with the exception permitted by paragraph 8, and that the part of the deck which forms the step is made effectively

weathertight. The extension shall be so arranged as to preclude the possibility of the bow door or ramp, where fitted, causing damage to it in the case of damage to, or detachment of, a bow door or any part of the ramp.

8 Where bow doors are fitted and a sloping loading ramp forms part of the extension of the collision bulkhead above the bulkhead deck of passenger ships and the freeboard deck of cargo ships, the ramp shall be weathertight over its complete length. In cargo ships, the part of the ramp which is more than 2.3 m above the freeboard deck may extend forward of the limit specified in paragraph 1 or 3. Ramps not meeting the above requirements shall be disregarded as an extension of the collision bulkhead.

9 The number of openings in the extension of the collision bulkhead above the freeboard deck shall be restricted to the minimum compatible with the design and normal operation of the ship. All such openings shall be capable of being closed weathertight.

10 Bulkheads shall be fitted separating the machinery space from cargo and accommodation spaces forward and aft and made watertight up to the bulkhead deck of passenger ships and the freeboard deck of cargo ships. An afterpeak bulkhead shall also be fitted and made watertight up to the bulkhead deck or the freeboard deck. The afterpeak bulkhead may, however, be stepped below the bulkhead deck or the freeboard deck, provided the degree of safety of the ship as regards subdivision is not thereby diminished.

11 In all cases stern tubes shall be enclosed in watertight spaces of moderate volume. In passenger ships the stern gland shall be situated in a watertight shaft tunnel or other watertight space separate from the stern tube compartment and of such volume that, if flooded by leakage through the stern gland, the bulkhead deck will not be immersed. In cargo ships other measures to minimize the danger of water penetrating into the ship in case of damage to stern tube arrangements may be taken at the discretion of the Administration.

Regulation 13

*Openings in watertight bulkheads below the bulkhead deck in passenger ships**

SEE INTERPRETATION 21

1 The number of openings in watertight bulkheads shall be reduced to the minimum compatible with the design and proper working of the ship; satisfactory means shall be provided for closing these openings.

2.1 Where pipes, scuppers, electric cables, etc., are carried through watertight bulkheads, arrangements shall be made to ensure the watertight integrity of the bulkheads.

2.2 Valves not forming part of a piping system shall not be permitted in watertight bulkheads.

2.3 Lead or other heat-sensitive materials shall not be used in systems which penetrate watertight bulkheads, where deterioration of such systems in the event of fire would impair the watertight integrity of the bulkheads.

3 No doors, manholes, or access openings are permitted in watertight transverse bulkheads dividing a cargo space from an adjoining cargo space, except as provided in paragraph 9.1 and in regulation 14.

4 Subject to paragraph 10, not more than one door, apart from the doors to shaft tunnels, may be fitted in each watertight bulkhead within spaces containing the main and auxiliary propulsion machinery, including boilers serving the needs of propulsion. Where two or more shafts are fitted, the tunnels shall be connected by an intercommunicating passage. There shall be only one door between the machinery space and the tunnel spaces where two shafts are fitted and only two doors where there are more than two shafts. All these doors shall be of the sliding type and shall be so located as to have their sills as high as practicable. The hand gear for operating these doors from above the bulkhead deck shall be situated outside the spaces containing the machinery.

* Refer to Revised guidance for watertight doors on passenger ships which may be opened during navigation (MSC.1/Circ.1564).

5.1 Watertight doors, except as provided in paragraph 9.1 or regulation 14, shall be power-operated sliding doors complying with the requirements of paragraph 7 capable of being closed simultaneously from the central operating console at the navigation bridge in not more than 60 s with the ship in the upright position.

5.2 The means of operation, whether by power or by hand, of any power-operated sliding watertight door shall be capable of closing the door with the ship listed to 15° either way. Consideration shall also be given to the forces which may act on either side of the door as may be experienced when water is flowing through the opening, applying a static head equivalent to a water height of at least 1 m above the sill on the centreline of the door.

5.3 Watertight door controls, including hydraulic piping and electric cables, shall be kept as close as practicable to the bulkhead in which the doors are fitted, in order to minimize the likelihood of them being involved in any damage which the ship may sustain. The positioning of watertight doors and their controls shall be such that if the ship sustains damage within one fifth of the breadth of the ship, as defined in regulation 2, such distance being measured at right angles to the centreline at the level of the deepest subdivision draught, the operation of the watertight doors clear of the damaged portion of the ship is not impaired.

6 All power-operated sliding watertight doors shall be provided with means of indication which will show at all remote operating positions whether the doors are open or closed. Remote operating positions shall only be at the navigation bridge as required by paragraph 7.1.5 and at the location where hand operation above the bulkhead deck is required by paragraph 7.1.4.

7.1 Each power-operated sliding watertight door:

- .1 shall have a vertical or horizontal motion;
- .2 shall, subject to paragraph 10, be normally limited to a maximum clear opening width of 1.2 m. The Administration may permit larger doors only to the extent considered necessary for the effective operation of the ship provided that other safety measures, including the following, are taken into consideration:
 - .1 special consideration shall be given to the strength of the door and its closing appliances in order to prevent leakages; and
 - .2 the door shall be located inboard the damage zone *B/5*;
- .3 shall be fitted with the necessary equipment to open and close the door using electric power, hydraulic power, or any other form of power that is acceptable to the Administration;
- .4 shall be provided with an individual hand-operated mechanism. It shall be possible to open and close the door by hand at the door itself from either side, and in addition, close the door from an accessible position above the bulkhead deck with an all round crank motion or some other movement providing the same degree of safety acceptable to the Administration. Direction of rotation or other movement is to be clearly indicated at all operating positions. The time necessary for the complete closure of the door, when operating by hand gear, shall not exceed 90 s with the ship in the upright position;
- .5 shall be provided with controls for opening and closing the door by power from both sides of the door and also for closing the door by power from the central operating console at the navigation bridge;
- .6 shall be provided with an audible alarm, distinct from any other alarm in the area, which will sound whenever the door is closed remotely by power and which shall sound for at least 5 s but no more than 10 s before the door begins to move and shall continue sounding until the door is completely closed. In the case of remote hand operation it is sufficient for the audible alarm to sound only when the door is moving. Additionally, in passenger areas and areas of high ambient noise the Administration may require the audible alarm to be supplemented by an intermittent visual signal at the door; and

- II-1**
- .7** shall have an approximately uniform rate of closure under power. The closure time, from the time the door begins to move to the time it reaches the completely closed position, shall in no case be less than 20 s or more than 40 s with the ship in the upright position.

7.2 The electrical power required for power-operated sliding watertight doors shall be supplied from the emergency switchboard either directly or by a dedicated distribution board situated above the bulkhead deck. The associated control, indication and alarm circuits shall be supplied from the emergency switchboard either directly or by a dedicated distribution board situated above the bulkhead deck and be capable of being automatically supplied by the transitional source of emergency electrical power required by regulation 42.3.1.3 in the event of failure of either the main or emergency source of electrical power.

7.3 Power-operated sliding watertight doors shall have either:

- .1** a centralized hydraulic system with two independent power sources each consisting of a motor and pump capable of simultaneously closing all doors. In addition, there shall be for the whole installation hydraulic accumulators of sufficient capacity to operate all the doors at least three times, i.e. closed-open-closed, against an adverse list of 15°. This operating cycle shall be capable of being carried out when the accumulator is at the pump cut-in pressure. The fluid used shall be chosen considering the temperatures liable to be encountered by the installation during its service. The power operating system shall be designed to minimize the possibility of having a single failure in the hydraulic piping adversely affect the operation of more than one door. The hydraulic system shall be provided with a low-level alarm for hydraulic fluid reservoirs serving the power-operated system and a low gas pressure alarm or other effective means of monitoring loss of stored energy in hydraulic accumulators. These alarms are to be audible and visual and shall be situated on the central operating console at the navigation bridge; or
- .2** an independent hydraulic system for each door with each power source consisting of a motor and pump capable of opening and closing the door. In addition, there shall be a hydraulic accumulator of sufficient capacity to operate the door at least three times, i.e. closed-open-closed, against an adverse list of 15°. This operating cycle shall be capable of being carried out when the accumulator is at the pump cut-in pressure. The fluid used shall be chosen considering the temperatures liable to be encountered by the installation during its service. A low gas pressure group alarm or other effective means of monitoring loss of stored energy in hydraulic accumulators shall be provided at the central operating console on the navigation bridge. Loss of stored energy indication at each local operating position shall also be provided; or
- .3** an independent electrical system and motor for each door with each power source consisting of a motor capable of opening and closing the door. The power source shall be capable of being automatically supplied by the transitional source of emergency electrical power as required by regulation 42.4.2 – in the event of failure of either the main or emergency source of electrical power and with sufficient capacity to operate the door at least three times, i.e. closed-open-closed, against an adverse list of 15°.

For the systems specified in paragraphs 7.3.1, 7.3.2 and 7.3.3, provision should be made as follows: Power systems for power-operated watertight sliding doors shall be separate from any other power system. A single failure in the electric or hydraulic power-operated systems excluding the hydraulic actuator shall not prevent the hand operation of any door.

7.4 Control handles shall be provided at each side of the bulkhead at a minimum height of 1.6 m above the floor and shall be so arranged as to enable persons passing through the doorway to hold both handles in the open position without being able to set the power closing mechanism in operation accidentally. The direction of movement of the handles in opening and closing the door shall be in the direction of door movement and shall be clearly indicated.

7.5 As far as practicable, electrical equipment and components for watertight doors shall be situated above the bulkhead deck and outside hazardous areas and spaces.

7.6 The enclosures of electrical components necessarily situated below the bulkhead deck shall provide suitable protection against the ingress of water.*

7.7 Electric power, control, indication and alarm circuits shall be protected against fault in such a way that a failure in one door circuit will not cause a failure in any other door circuit. Short circuits or other faults in the alarm or indicator circuits of a door shall not result in a loss of power operation of that door. Arrangements shall be such that leakage of water into the electrical equipment located below the bulkhead deck will not cause the door to open.

7.8 A single electrical failure in the power operating or control system of a power-operated sliding watertight door shall not result in a closed door opening. Availability of the power supply should be continuously monitored at a point in the electrical circuit as near as practicable to each of the motors required by paragraph 7.3. Loss of any such power supply should activate an audible and visual alarm at the central operating console at the navigation bridge.

8.1 The central operating console at the navigation bridge shall have a "master mode" switch with two modes of control: a "local control" mode which shall allow any door to be locally opened and locally closed after use without automatic closure, and a "doors closed" mode which shall automatically close any door that is open. The "doors closed" mode shall automatically close any door that is open. The "doors closed" mode shall permit doors to be opened locally and shall automatically re-close the doors upon release of the local control mechanism. The "master mode" switch shall normally be in the "local control" mode. The "doors closed" mode shall only be used in an emergency or for testing purposes. Special consideration shall be given to the reliability of the "master mode" switch.

8.2 The central operating console at the navigation bridge shall be provided with a diagram showing the location of each door, with visual indicators to show whether each door is open or closed. A red light shall indicate a door is fully open and a green light shall indicate a door is fully closed. When the door is closed remotely the red light shall indicate the intermediate position by flashing. The indicating circuit shall be independent of the control circuit for each door.

8.3 It shall not be possible to remotely open any door from the central operating console.

9.1 If the Administration is satisfied that such doors are essential, watertight doors of satisfactory construction may be fitted in watertight bulkheads dividing cargo between deck spaces. Such doors may be hinged, rolling or sliding doors but shall not be remotely controlled. They shall be fitted at the highest level and as far from the shell plating as practicable, but in no case shall the outboard vertical edges be situated at a distance from the shell plating which is less than one fifth of the breadth of the ship, as defined in regulation 2, such distance being measured at right angles to the centreline at the level of the deepest subdivision draught.

9.2 Should any such doors be accessible during the voyage, they shall be fitted with a device which prevents unauthorized opening. When it is proposed to fit such doors, the number and arrangements shall receive the special consideration of the Administration.

10 Portable plates on bulkheads shall not be permitted except in machinery spaces. The Administration may permit not more than one power-operated sliding watertight door in each watertight bulkhead larger than those specified in paragraph 7.1.2 to be substituted for these portable plates, provided these doors are intended to remain closed during navigation except in case of urgent necessity at the discretion of the master. These doors need not meet the requirements of paragraph 7.1.4 regarding complete closure by hand-operated gear in 90 s.

* Refer to the following publication IEC 60529:2003:

- .1 electrical motors, associated circuits and control components; protected to IPX 7 standard;
- .2 door position indicators and associated circuit components; protected to IPX 8 standard; and
- .3 door movement warning signals; protected to IPX 6 standard.

Other arrangements for the enclosures of electrical components may be fitted provided the Administration is satisfied that an equivalent protection is achieved. The water pressure IPX 8 shall be based on the pressure that may occur at the location of the component during flooding for a period of 36 h.

11.1 Where trunkways or tunnels for access from crew accommodation to the machinery spaces, for piping or for any other purpose, are carried through watertight bulkheads, they shall be watertight and in accordance with the requirements of regulation 16-1. The access to at least one end of each such tunnel or trunkway, if used as a passage at sea, shall be through a trunk extending watertight to a height sufficient to permit access above the bulkhead deck. The access to the other end of the trunkway or tunnel may be through a watertight door of the type required by its location in the ship. Such trunkways or tunnels shall not extend through the first subdivision bulkhead abaft the collision bulkhead.

11.2 Where it is proposed to fit tunnels piercing watertight bulkheads, these shall receive the special consideration of the Administration.

11.3 Where trunkways in connection with refrigerated cargo and ventilation or forced draught trunks are carried through more than one watertight bulkhead, the means of closure at such openings shall be operated by power and be capable of being closed from a central position situated above the bulkhead deck.

Regulation 13-1

Openings in watertight bulkheads and internal decks in cargo ships

SEE INTERPRETATION 21

1 The number of openings in watertight subdivisions is to be kept to a minimum compatible with the design and proper working of the ship. Where penetrations of watertight bulkheads and internal decks are necessary for access, piping, ventilation, electrical cables, etc., arrangements are to be made to maintain the watertight integrity. The Administration may permit relaxation in the watertightness of openings above the freeboard deck, provided that it is demonstrated that any progressive flooding can be easily controlled and that the safety of the ship is not impaired.

2 Doors provided to ensure the watertight integrity of internal openings which are used while at sea are to be sliding watertight doors capable of being remotely closed from the bridge and are also to be operable locally from each side of the bulkhead. Indicators are to be provided at the control position showing whether the doors are open or closed, and an audible alarm is to be provided at the door closure. The power, control and indicators are to be operable in the event of main power failure. Particular attention is to be paid to minimizing the effect of control system failure. Each power-operated sliding watertight door shall be provided with an individual hand-operated mechanism. It shall be possible to open and close the door by hand at the door itself from both sides.

3 Access doors and access hatch covers normally closed at sea, intended to ensure the watertight integrity of internal openings, shall be provided with means of indication locally and on the bridge showing whether these doors or hatch covers are open or closed. A notice is to be affixed to each such door or hatch cover to the effect that it is not to be left open.

4 Watertight doors or ramps of satisfactory construction may be fitted to internally subdivide large cargo spaces, provided that the Administration is satisfied that such doors or ramps are essential. These doors or ramps may be hinged, rolling or sliding doors or ramps, but shall not be remotely controlled. Should any of the doors or ramps be accessible during the voyage, they shall be fitted with a device which prevents unauthorized opening.

5 Other closing appliances which are kept permanently closed at sea to ensure the watertight integrity of internal openings shall be provided with a notice which is to be affixed to each such closing appliance to the effect that it is to be kept closed. Manholes fitted with closely bolted covers need not be so marked.

Regulation 14

Passenger ships carrying goods vehicles and accompanying personnel

1 This regulation applies to passenger ships designed or adapted for the carriage of goods vehicles and accompanying personnel.

- 2 If in such a ship the total number of passengers, which includes personnel accompanying vehicles, does not exceed $12 + A_d/25$, where A_d = total deck area (square metres) of spaces available for the stowage of goods vehicles and where the clear height at the stowage position and at the entrance to such spaces is not less than 4 m, the provisions of regulations 13.9.1 and 13.9.2 in respect of watertight doors apply except that the doors may be fitted at any level in watertight bulkheads dividing cargo spaces. Additionally, indicators are required on the navigation bridge to show automatically when each door is closed and all door fastenings are secured.
- 3 The ship may not be certified for a higher number of passengers than assumed in paragraph 2, if a watertight door has been fitted in accordance with this regulation.

Regulation 15

Openings in the shell plating below the bulkhead deck of passenger ships and the freeboard deck of cargo ships

- 1 The number of openings in the shell plating shall be reduced to the minimum compatible with the design and proper working of the ship.
- 2 The arrangement and efficiency of the means for closing any opening in the shell plating shall be consistent with its intended purpose and the position in which it is fitted and generally to the satisfaction of the Administration.
- 3.1 Subject to the requirements of the International Convention on Load Lines in force, no sidescuttle shall be fitted in such a position that its sill is below a line drawn parallel to the bulkhead deck at side and having its lowest point 2.5% of the breadth of the ship above the deepest subdivision draught, or 500 mm, whichever is the greater.
- 3.2 All sidescuttles the sills of which are below the bulkhead deck of passenger ships and the freeboard deck of cargo ships, as permitted by paragraph 3.1, shall be of such construction as will effectively prevent any person opening them without the consent of the master of the ship.
- 4 Efficient hinged inside deadlights, so arranged that they can be easily and effectively closed and secured watertight, shall be fitted to all sidescuttles except that, abaft one eighth of the ship's length from the forward perpendicular and above a line drawn parallel to the bulkhead deck at side and having its lowest point at a height of 3.7 m plus 2.5% of the breadth of the ship above the deepest subdivision draught, the deadlights may be portable in passenger accommodation, unless the deadlights are required by the International Convention on Load Lines in force to be permanently attached in their proper positions. Such portable deadlights shall be stowed adjacent to the sidescuttles they serve.
- 5.1 No sidescuttles shall be fitted in any spaces which are appropriated exclusively to the carriage of cargo.
- 5.2 Sidescuttles may, however, be fitted in spaces appropriated alternatively to the carriage of cargo or passengers, but they shall be of such construction as will effectively prevent any person opening them or their deadlights without the consent of the master.
- 6 Automatic ventilating sidescuttles shall not be fitted in the shell plating below the bulkhead deck of passenger ships and the freeboard deck of cargo ships without the special sanction of the Administration.
- 7 The number of scuppers, sanitary discharges and other similar openings in the shell plating shall be reduced to the minimum either by making each discharge serve for as many as possible of the sanitary and other pipes or in any other satisfactory manner.
- 8.1 All inlets and discharges in the shell plating shall be fitted with efficient and accessible arrangements for preventing the accidental admission of water into the ship.
- 8.2.1 Subject to the requirements of the International Convention on Load Lines in force, and except as provided in paragraph 8.3, each separate discharge led through the shell plating from spaces below the bulkhead deck of passenger ships and the freeboard deck of cargo ships shall be provided with either one automatic non-return valve fitted with a positive means of closing it from above the bulkhead deck of passenger

ships and the freeboard deck of cargo ships or with two automatic non-return valves without positive means of closing, provided that the inboard valve is situated above the deepest subdivision draught and is always accessible for examination under service conditions. Where a valve with positive means of closing is fitted, the operating position above the bulkhead deck of passenger ships and the freeboard deck of cargo ships shall always be readily accessible and means shall be provided for indicating whether the valve is open or closed.

8.2.2 The requirements of the International Convention on Load Lines in force shall apply to discharges led through the shell plating from spaces above the bulkhead deck of passenger ships and the freeboard deck of cargo ships.

8.3 Machinery space, main and auxiliary sea inlets and discharges in connection with the operation of machinery shall be fitted with readily accessible valves between the pipes and the shell plating or between the pipes and fabricated boxes attached to the shell plating. In manned machinery spaces the valves may be controlled locally and shall be provided with indicators showing whether they are open or closed.

8.4 Moving parts penetrating the shell plating below the deepest subdivision draught shall be fitted with a watertight sealing arrangement acceptable to the Administration. The inboard gland shall be located within a watertight space of such volume that, if flooded, the bulkhead deck of passenger ships and the freeboard deck of cargo ships will not be submerged. The Administration may require that if such compartment is flooded, essential or emergency power and lighting, internal communication, signals or other emergency devices must remain available in other parts of the ship.

8.5 All shell fittings and valves required by this regulation shall be of steel, bronze or other approved ductile material. Valves of ordinary cast iron or similar material are not acceptable. All pipes to which this regulation refers shall be of steel or other equivalent material to the satisfaction of the Administration.

9 Gangway, cargo and fuelling ports fitted below the bulkhead deck of passenger ships and the freeboard deck of cargo ships shall be watertight and in no case be so fitted as to have their lowest point below the deepest subdivision draught.

10.1 The inboard opening of each ash-chute, rubbish-chute, etc., shall be fitted with an efficient cover.

10.2 If the inboard opening is situated below the bulkhead deck of passenger ships and the freeboard deck of cargo ships, the cover shall be watertight and, in addition, an automatic non-return valve shall be fitted in the chute in an easily accessible position above the deepest subdivision draught.

Regulation 15-1

External openings in cargo ships

SEE INTERPRETATION 21

1 All external openings leading to compartments assumed intact in the damage analysis, which are below the final damage waterline, are required to be watertight.

2 External openings required to be watertight in accordance with paragraph 1 shall, except for cargo hatch covers, be fitted with indicators on the bridge.

3 Openings in the shell plating below the deck limiting the vertical extent of damage shall be fitted with a device that prevents unauthorized opening if they are accessible during the voyage.

4 Other closing appliances which are kept permanently closed at sea to ensure the watertight integrity of external openings shall be provided with a notice affixed to each appliance to the effect that it is to be kept closed. Manholes fitted with closely bolted covers need not be so marked.

Regulation 16

Construction and initial tests of watertight closures

- 1.1 The design, materials and construction of all watertight closures such as doors, hatches, sidescuttles, gangway and cargo ports, valves, pipes, ash-chutes and rubbish chutes referred to in these regulations shall be to the satisfaction of the Administration.
- 1.2 Such valves, doors, hatches and mechanisms shall be suitably marked to ensure that they may be properly used to provide maximum safety.
- 1.3 The frames of vertical watertight doors shall have no groove at the bottom in which dirt might lodge and prevent the door closing properly.
- 2 Watertight doors and hatches shall be tested by water pressure to the maximum head of water they might sustain in a final or intermediate stage of flooding. For cargo ships not covered by damage stability requirements, watertight doors and hatches shall be tested by water pressure to a head of water measured from the lower edge of the opening to 1 m above the freeboard deck. Where testing of individual doors and hatches is not carried out because of possible damage to insulation or outfitting items, testing of individual doors and hatches may be replaced by a prototype pressure test of each type and size of door or hatch with a test pressure corresponding at least to the head required for the individual location. The prototype test shall be carried out before the door or hatch is fitted. The installation method and procedure for fitting the door or hatch on board shall correspond to that of the prototype test. When fitted on board, each door or hatch shall be checked for proper seating between the bulkhead, the frame and the door or between deck, the coaming and the hatch.

Regulation 16-1

Construction and initial tests of watertight decks, trunks, etc.

- 1 Watertight decks, trunks, tunnels, duct keels and ventilators shall be of the same strength as watertight bulkheads at corresponding levels. The means used for making them watertight, and the arrangements adopted for closing openings in them, shall be to the satisfaction of the Administration. Watertight ventilators and trunks shall be carried at least up to the bulkhead deck in passenger ships and up to the freeboard deck in cargo ships.
- 2 In passenger ships, where a ventilation trunk passing through a structure penetrates a watertight area of the bulkhead deck, the trunk shall be capable of withstanding the water pressure that may be present within the trunk, after having taken into account the maximum heel angle during flooding, in accordance with regulation 7-2.
- 3 In ro-ro passenger ships, where all or part of the penetration of the bulkhead deck is on the main ro-ro deck, the trunk shall be capable of withstanding impact pressure due to internal water motions (sloshing) of water trapped on the ro-ro deck.
- 4 After completion, a hose or flooding test shall be applied to watertight decks and a hose test to watertight trunks, tunnels and ventilators.

Regulation 17

Internal watertight integrity of passenger ships above the bulkhead deck

SEE INTERPRETATION 21

- 1 The Administration may require that all reasonable and practicable measures shall be taken to limit the entry and spread of water above the bulkhead deck. Such measures may include partial bulkheads or webs. When partial watertight bulkheads and webs are fitted on the bulkhead deck, above or in the immediate vicinity of watertight bulkheads, they shall have watertight shell and bulkhead deck connections so as to restrict the flow of water along the deck when the ship is in a heeled damaged condition. Where the partial watertight bulkhead does not line up with the bulkhead below, the bulkhead deck between shall be made

effectively watertight. Where openings, pipes, scuppers, electric cables, etc., are carried through the partial watertight bulkheads or decks within the immersed part of the bulkhead deck, arrangements shall be made to ensure the watertight integrity of the structure above the bulkhead deck.*

2 All openings in the exposed weather deck shall have coamings of ample height and strength and shall be provided with efficient means for expeditiously closing them weathertight. Freeing ports, open rails and scuppers shall be fitted as necessary for rapidly clearing the weather deck of water under all weather conditions.

3 Air pipes terminating within a superstructure which are not fitted with watertight means of closure shall be considered as unprotected openings when applying regulation 7-2.6.1.1.

4 Sidescuttles, gangway, cargo and fuelling ports and other means for closing openings in the shell plating above the bulkhead deck shall be of efficient design and construction and of sufficient strength having regard to the spaces in which they are fitted and their positions relative to the deepest subdivision draught.†

5 Efficient inside deadlights, so arranged that they can be easily and effectively closed and secured watertight, shall be provided for all sidescuttles to spaces below the first deck above the bulkhead deck.

Regulation 17-1

Integrity of the hull and superstructure, damage prevention and control on ro-ro passenger ships

SEE INTERPRETATION 21

1.1 Subject to the provisions of paragraphs 1.2 and 1.3, all accesses that lead to spaces below the bulkhead deck shall have a lowest point which is not less than 2.5 m above the bulkhead deck.

SEE INTERPRETATION 22

1.2 Where vehicle ramps are installed to give access to spaces below the bulkhead deck, their openings shall be able to be closed weathertight to prevent ingress of water below, alarmed and indicated to the navigation bridge.

1.3 The Administration may permit the fitting of particular accesses to spaces below the bulkhead deck provided they are necessary for the essential working of the ship, e.g. the movement of machinery and stores, subject to such accesses being made watertight, alarmed and indicated on the navigation bridge.

2 Indicators shall be provided on the navigation bridge for all shell doors, loading doors and other closing appliances which, if left open or not properly secured, could, in the opinion of the Administration, lead to flooding of a special category space or ro-ro space. The indicator system shall be designed on the fail-safe principle and shall show by visual alarms if the door is not fully closed or if any of the securing arrangements are not in place and fully locked and by audible alarms if such door or closing appliances become open or the securing arrangements become unsecured. The indicator panel on the navigation bridge shall be equipped with a mode selection function "harbour/sea voyage" so arranged that an audible alarm is given on the navigation bridge if the ship leaves harbour with the bow doors, inner doors, stern ramp or any other side shell doors not closed or any closing device not in the correct position. The power supply for the indicator system shall be independent of the power supply for operating and securing the doors.

3 Television surveillance and a water leakage detection system shall be arranged to provide an indication to the navigation bridge and to the engine control station of any leakage through inner and outer bow doors, stern doors or any other shell doors which could lead to flooding of special category spaces or ro-ro spaces.

* Refer to *Guidance notes on the integrity of flooding boundaries above the bulkhead deck of passenger ships for proper application of regulations II-1/8 and 20, paragraph 1, of SOLAS 1974, as amended (MSC/Circ.541, as may be amended).*

† Refer to *Recommendation on strength and security and locking arrangements of shell doors on ro-ro passenger ships (resolution A.793(19)).*

Part B-3

Subdivision load line assignment for passenger ships

Regulation 18

Assigning, marking and recording of subdivision load lines for passenger ships

- 1 In order that the required degree of subdivision shall be maintained, a load line corresponding to the approved subdivision draught shall be assigned and marked on the ship's sides. A ship intended for alternating modes of operation may, if the owners desire, have one or more additional load lines assigned and marked to correspond with the subdivision draughts which the Administration may approve for the alternative service configurations. Each service configuration so approved shall comply with part B-1 of this chapter independently of the results obtained for other modes of operation.
- 2 The subdivision load lines assigned and marked shall be recorded in the Passenger Ship Safety Certificate, and shall be distinguished by the notation P1 for the principal passenger service configuration, and P2, P3, etc., for the alternative configurations. The principal passenger configuration shall be taken as the mode of operation in which the required subdivision index R will have the highest value.
- 3 The freeboard corresponding to each of these load lines shall be measured at the same position and from the same deck line as the freeboards determined in accordance with the International Convention on Load Lines in force.
- 4 The freeboard corresponding to each approved subdivision load line and the service configuration for which it is approved shall be clearly indicated on the Passenger Ship Safety Certificate.
- 5 In no case shall any subdivision load line mark be placed above the deepest load line in salt water as determined by the strength of the ship or the International Convention on Load Lines in force.
- 6 Whatever may be the position of the subdivision load line marks, a ship shall in no case be loaded so as to submerge the load line mark appropriate to the season and locality as determined in accordance with the International Convention on Load Lines in force.
- 7 A ship shall in no case be so loaded that when it is in salt water the subdivision load line mark appropriate to the particular voyage and service configuration is submerged.

Part B-4

Stability management

Regulation 19

*Damage control information**

- 1 There shall be permanently exhibited, or readily available on the navigation bridge, for the guidance of the officer in charge of the ship, plans showing clearly for each deck and hold the boundaries of the watertight compartments, the openings therein with the means of closure and position of any controls thereof, and the arrangements for the correction of any list due to flooding. In addition, booklets containing the aforementioned information shall be made available to the officers of the ship.
- 2 General precautions to be included shall consist of a listing of equipment, conditions and operational procedures considered by the Administration to be necessary to maintain watertight integrity under normal ship operations.
- 3 Specific precautions to be included shall consist of a listing of elements (i.e. closures, security of cargo, sounding of alarms, etc.) considered by the Administration to be vital to the survival of the ship, passengers and crew.
- 4 In case of ships to which damage stability requirements of part B-1 apply, damage stability information shall provide the master with a simple and easily understandable way of assessing the ship's survivability in all damage cases involving a compartment or group of compartments.

Regulation 19-1

Damage control drills for passenger ships

- 1 This regulation applies to passenger ships constructed before, on or after 1 January 2020.
- 2 A damage control drill shall take place at least every three months. The entire crew need not participate in every drill, but only those crew members with damage control responsibilities.
- 3 The damage control drill scenarios shall vary each drill so that emergency conditions are simulated for different damage conditions and shall, as far as practicable, be conducted as if there were an actual emergency.
- 4 Each damage control drill shall include:
 - .1 for crew members with damage control responsibilities, reporting to stations and preparing for the duties described in the muster list required by regulation III/8;
 - .2 use of the damage control information and the onboard damage stability computer, if fitted, to conduct stability assessments for the simulated damage conditions;
 - .3 establishment of the communications link between the ship and shore-based support, if provided;
 - .4 operation of watertight doors and other watertight closures;

* Refer to *Guidelines for damage control plans and information to the master* (MSC.1/Circ.1245, as amended by MSC.1/Circ.1570) and to the *Guidelines for verification of damage stability requirements for tankers* (MSC.1/Circ.1461).

- .5 demonstrating proficiency in the use of the flooding detection system, if fitted, in accordance with muster list duties;
- .6 demonstrating proficiency in the use of cross-flooding and equalization systems, if fitted, in accordance with muster list duties;
- .7 operation of bilge pumps and checking of bilge alarms and automatic bilge pump starting systems; and
- .8 instruction in damage survey and use of the ship's damage control systems.

5 At least one damage control drill each year shall include activation of the shore-based support, if provided in compliance with regulation II-1/8-1.3, to conduct stability assessments for the simulated damage conditions.

6 Every crew member with assigned damage control responsibilities shall be familiarized with their duties and about the damage control information before the voyage begins.

7 A record of each damage control drill shall be maintained in the same manner as prescribed for the other drills in regulation III/19.5.

Regulation 20

Loading of ships

1 On completion of loading of the ship and prior to its departure, the master shall determine the ship's trim and stability and also ascertain and record that the ship is upright and in compliance with stability criteria in relevant regulations. The determination of the ship's stability shall always be made by calculation or by ensuring that the ship is loaded according to one of the precalculated loading conditions within the approved stability information. The Administration may accept the use of an electronic loading and stability computer or equivalent means for this purpose.

2 Water ballast should not in general be carried in tanks intended for oil fuel. In ships in which it is not practicable to avoid putting water in oil fuel tanks, oily-water separating equipment to the satisfaction of the Administration shall be fitted, or other alternative means, such as discharge to shore facilities, acceptable to the Administration shall be provided for disposing of the oily-water ballast.

3 The provisions of this regulation are without prejudice to the provisions of the International Convention for the Prevention of Pollution from Ships in force.

Regulation 21

Periodical operation and inspection of watertight doors, etc., in passenger ships

1 Operational tests of watertight doors, sidescuttles, valves and closing mechanisms of scuppers, ash-chutes and rubbish-chutes shall take place weekly. In ships in which the voyage exceeds one week in duration a complete set of operational tests shall be held before the voyage commences, and others thereafter at least once a week during the voyage.

2 All watertight doors, both hinged and power-operated, in watertight bulkheads, in use at sea, shall be operated daily.

3 The watertight doors and all mechanisms and indicators connected therewith, all valves the closing of which is necessary to make a compartment watertight, and all valves the operation of which is necessary for damage control cross-connections shall be periodically inspected at sea at least once a week.

4 A record of all operational tests and inspections required by this regulation shall be recorded in the logbook with an explicit record of any defects which may be disclosed.

Regulation 22

Prevention and control of water ingress, etc.

SEE INTERPRETATION 21

1 All watertight doors shall be kept closed during navigation except that they may be opened during navigation as specified in paragraph 3. Watertight doors of a width of more than 1.2 m in machinery spaces as permitted by regulation 13.10 may only be opened in the circumstances detailed in that regulation. Any door which is opened in accordance with this paragraph shall be ready to be immediately closed.

2 Watertight doors located below the bulkhead deck of passenger ships and the freeboard deck of cargo ships having a maximum clear opening width of more than 1.2 m shall be kept closed during navigation, except for limited periods when absolutely necessary as determined by the Administration.

3 A watertight door may be opened during navigation to permit the passage of passengers or crew, or when work in the immediate vicinity of the door necessitates it being opened. The door must be immediately closed when transit through the door is complete or when the task which necessitated it being open is finished. The Administration shall authorize that such a watertight door may be opened during navigation only after careful consideration of the impact on ship operations and survivability taking into account guidance issued by the Organization.* A watertight door permitted to be opened during navigation shall be clearly indicated in the ship's stability information and shall always be ready to be immediately closed.

4 Portable plates on bulkheads shall always be in place before the voyage commences and shall not be removed during navigation except in case of urgent necessity at the discretion of the master. The necessary precautions shall be taken in replacing them to ensure that the joints are watertight. Power-operated sliding watertight doors permitted in machinery spaces in accordance with regulation 13.10 shall be closed before the voyage commences and shall remain closed during navigation except in case of urgent necessity at the discretion of the master.

5 Watertight doors fitted in watertight bulkheads dividing cargo between deck spaces in accordance with regulation 13.9.1 shall be closed before the voyage commences and shall be kept closed during navigation. The time at which such doors are opened or closed shall be recorded in such logbook as may be prescribed by the Administration.

6 Gangway, cargo and fuelling ports fitted below the bulkhead deck of passenger ships and the freeboard deck of cargo ships shall be effectively closed and secured watertight before voyage commences, and shall be kept closed during navigation.

7 The following doors, located above the bulkhead deck of passenger ships and the freeboard deck of cargo ships, shall be closed and locked before the voyage commences and shall remain closed and locked until the ship is at its next berth:

- .1 cargo loading doors in the shell or the boundaries of enclosed superstructures;
- .2 bow visors fitted in positions as indicated in paragraph 7.1;
- .3 cargo loading doors in the collision bulkhead; and
- .4 ramps forming an alternative closure to those defined in paragraphs 7.1 to 7.3 inclusive.

8 Where a door cannot be opened or closed while the ship is at the berth, such a door may be opened or left open while the ship approaches or draws away from the berth, but only so far as may be necessary to enable the door to be immediately operated. In any case, the inner bow door must be kept closed.

9 Notwithstanding the requirements of paragraphs 7.1 and 7.4, the Administration may authorize that particular doors can be opened at the discretion of the master, if necessary for the operation of the ship or the embarking and disembarking of passengers when the ship is at safe anchorage and provided that the safety of the ship is not impaired.

* Refer to the *Revised guidance for watertight doors on passenger ships which may be opened during navigation* (MSC.1/Circ.1564).

10 The master shall ensure that an effective system of supervision and reporting of the closing and opening of the doors referred to in paragraph 7 is implemented.

11 The master shall ensure, before any voyage commences, that an entry in such logbook as may be prescribed by the Administration is made of the time the doors specified in paragraph 12 are closed and the time at which particular doors are opened in accordance with paragraph 13.

12 Hinged doors, portable plates, sidescuttles, gangway, cargo and bunkering ports and other openings, which are required by these regulations to be kept closed during navigation, shall be closed before the voyage commences. The time at which such doors are opened and closed (if permissible under these regulations) shall be recorded in such logbook as may be prescribed by the Administration.

13 Where in a between-deck, the sills of any of the sidescuttles referred to in regulation 15.3.2 are below a line drawn parallel to the bulkhead deck at side of passenger ships and the freeboard deck at side of cargo ships, and having its lowest point 1.4 m plus 2.5% of the breadth of the ship above the water when the voyage commences, all the sidescuttles in that between-deck shall be closed watertight and locked before the voyage commences, and they shall not be opened before the ship arrives at the next port. In the application of this paragraph the appropriate allowance for fresh water may be made when applicable.

- .1** The time at which such sidescuttles are opened in port and closed and locked before the voyage commences shall be recorded in such logbook as may be prescribed by the Administration.
- .2** For any ship that has one or more sidescuttles so placed that the requirements of paragraph 13 would apply when it was floating at its deepest subdivision draught, the Administration may indicate the limiting mean draught at which these sidescuttles will have their sills above the line drawn parallel to the bulkhead deck at side of passenger ships and the freeboard deck at side of cargo ships, and having its lowest point 1.4 m plus 2.5% of the breadth of the ship above the waterline corresponding to the limiting mean draught, and at which it will therefore be permissible for the voyage to commence without them being closed and locked and to be opened during navigation on the responsibility of the master during navigation. In tropical zones as defined in the International Convention on Load Lines in force, this limiting draught may be increased by 0.3 m.

14 Sidescuttles and their deadlights which will not be accessible during navigation shall be closed and secured before the voyage commences.

15 If cargo is carried in spaces referred to in regulation 15.5.2, the sidescuttles and their deadlights shall be closed watertight and locked before the cargo is shipped and the time at which such scuttles and deadlights are closed and locked shall be recorded in such logbook as may be prescribed by the Administration.

16 When a rubbish-chute, etc. is not in use, both the cover and the valve required by regulation 15.10.2 shall be kept closed and secured.

Regulation 22-1

Flooding detection systems for passenger ships carrying 36 or more persons

SEE INTERPRETATION 23

A flooding detection system for watertight spaces below the bulkhead deck shall be provided based on the guidelines developed by the Organization.*

* Refer to *Guidelines for flooding detection systems on passenger ships* (MSC.1/Circ.1291).

Regulation 23

Special requirements for ro-ro passenger ships

- 1 Special category spaces and ro-ro spaces shall be continuously patrolled or monitored by effective means, such as television surveillance, so that any movement of vehicles in adverse weather conditions and unauthorized access by passengers thereto can be detected during navigation.
- 2 Documented operating procedures for closing and securing all shell doors, loading doors and other closing appliances which, if left open or not properly secured, could, in the opinion of the Administration, lead to flooding of a special category space or ro-ro space, shall be kept on board and posted at an appropriate place.
- 3 All accesses from the ro-ro deck and vehicle ramps that lead to spaces below the bulkhead deck shall be closed before the voyage commences and shall remain closed until the ship is at its next berth.
- 4 The master shall ensure that an effective system of supervision and reporting of the closing and opening of such accesses referred to in paragraph 3 is implemented.
- 5 The master shall ensure, before the voyage commences, that an entry in the logbook, as required by regulation 22.12, is made of the time of the last closing of the accesses referred to in paragraph 3.
- 6 Notwithstanding the requirements of paragraph 3, the Administration may permit some accesses to be opened during the voyage, but only for a period sufficient to permit through passage and, if required, for the essential working of the ship.
- 7 All transverse or longitudinal bulkheads which are taken into account as effective to confine the seawater accumulated on the ro-ro deck shall be in place and secured before the voyage commences and remain in place and secured until the ship is at its next berth.
- 8 Notwithstanding the requirements of paragraph 7, the Administration may permit some accesses within such bulkheads to be opened during the voyage but only for sufficient time to permit through passage and, if required, for the essential working of the ship.
- 9 In all ro-ro passenger ships, the master or the designated officer shall ensure that, without the express consent of the master or the designated officer, no passengers are allowed access to an enclosed ro-ro deck during navigation.

Regulation 24

Additional requirements for prevention and control of water ingress, etc. in cargo ships

- 1 Openings in the shell plating below the deck limiting the vertical extent of damage shall be kept permanently closed during navigation.
- 2 Notwithstanding the requirements of paragraph 3, the Administration may authorize that particular doors may be opened at the discretion of the master, if necessary for the operation of the ship and provided that the safety of the ship is not impaired.
- 3 Watertight doors or ramps fitted to internally subdivide large cargo spaces shall be closed before the voyage commences and shall be kept closed during navigation. The time at which such doors are opened or closed shall be recorded in such logbook as may be prescribed by the Administration.
- 4 The use of access doors and hatch covers intended to ensure the watertight integrity of internal openings shall be authorized by the officer of the watch.

Regulation 25

Water level detectors on single hold cargo ships other than bulk carriers

- 1 Single hold cargo ships other than bulk carriers constructed before 1 January 2007 shall comply with the requirements of this regulation not later than 31 December 2009.
- 2 Ships having a length (L) of less than 80 m, or 100 m if constructed before 1 July 1998, and a single cargo hold below the freeboard deck or cargo holds below the freeboard deck which are not separated by at least one bulkhead made watertight up to that deck shall be fitted in such space or spaces with water level detectors.*
 - .1 give an audible and visual alarm at the navigation bridge when the water level above the inner bottom in the cargo hold reaches a height of not less than 0.3 m, and another when such level reaches not more than 15% of the mean depth of the cargo hold; and
 - .2 be fitted at the aft end of the hold, or above its lowest part where the inner bottom is not parallel to the designed waterline. Where webs or partial watertight bulkheads are fitted above the inner bottom, Administrations may require the fitting of additional detectors.
- 4 The water level detectors required by paragraph 2 need not be fitted in ships complying with regulation XII/12, or in ships having watertight side compartments each side of the cargo hold length extending vertically at least from inner bottom to freeboard deck.

* Refer to *Performance standards for water level detectors on bulk carriers and single hold cargo ships other than bulk carriers* (resolution MSC.188(79)).

Part C

Machinery installations

(Except where expressly provided otherwise part C applies to passenger ships and cargo ships)

Regulation 26

General

1 The machinery, boilers and other pressure vessels, associated piping systems and fittings shall be of a design and construction adequate for the service for which they are intended and shall be so installed and protected as to reduce to a minimum any danger to persons on board, due regard being paid to moving parts, hot surfaces and other hazards. The design shall have regard to materials used in construction, the purpose for which the equipment is intended, the working conditions to which it will be subjected and the environmental conditions on board.*

2 The Administration shall give special consideration to the reliability of single essential propulsion components and may require a separate source of propulsion power sufficient to give the ship a navigable speed, especially in the case of unconventional arrangements.

3 Means shall be provided whereby normal operation of propulsion machinery can be sustained or restored even though one of the essential auxiliaries becomes inoperative. Special consideration shall be given to the malfunctioning of:

- .1 a generating set which serves as a main source of electrical power;
- .2 the sources of steam supply;
- .3 the boiler feedwater systems;
- .4 the fuel oil supply systems for boilers or engines;†

SEE INTERPRETATION 24

- .5 the sources of lubricating oil pressure;
- .6 the sources of water pressure;
- .7 a condensate pump and the arrangements to maintain vacuum in condensers;
- .8 the mechanical air supply for boilers;
- .9 an air compressor and receiver for starting or control purposes; and
- .10 the hydraulic, pneumatic or electrical means for control in main propulsion machinery including controllable pitch propellers.

However, the Administration, having regard to overall safety considerations, may accept a partial reduction in propulsion capability from normal operation.

* Refer to *Guidelines for engine-room layout, design and arrangement* (MSC/Circ.834).

† Refer to *Guidelines to minimize leakages from flammable liquid systems* (MSC/Circ.647) and *Guidelines on engine-room oil fuel systems* (MSC/Circ.851).

4 Means shall be provided to ensure that the machinery can be brought into operation from the dead ship condition without external aid.

SEE INTERPRETATION 25

5 All boilers, all parts of machinery, all steam, hydraulic, pneumatic and other systems and their associated fittings which are under internal pressure shall be subjected to appropriate tests including a pressure test before being put into service for the first time.

6 Main propulsion machinery and all auxiliary machinery essential to the propulsion and the safety of the ship shall, as fitted in the ship, be designed to operate when the ship is upright and when inclined at any angle of list up to and including 15° either way under static conditions and 22.5° under dynamic conditions (rolling) either way and simultaneously inclined dynamically (pitching) 7.5° by bow or stern. The Administration may permit deviation from these angles, taking into consideration the type, size and service conditions of the ship.

7 Provision shall be made to facilitate cleaning, inspection and maintenance of main propulsion and auxiliary machinery including boilers and pressure vessels.

8 Special consideration shall be given to the design, construction and installation of propulsion machinery systems so that any mode of their vibrations shall not cause undue stresses in this machinery in the normal operating ranges.

9 Non-metallic expansion joints in piping systems, if located in a system which penetrates the ship's side and both the penetration and the non-metallic expansion joint are located below the deepest load waterline, shall be inspected as part of the surveys prescribed in regulation I/10(a) and replaced as necessary, or at an interval recommended by the manufacturer.

10 Operating and maintenance instructions and engineering drawings for ship machinery and equipment essential to the safe operation of the ship shall be written in a language understandable by those officers and crew members who are required to understand such information in the performance of their duties.

11 Location and arrangement of vent pipes for fuel oil service, settling and lubrication oil tanks shall be such that in the event of a broken vent pipe this shall not directly lead to the risk of ingress of seawater splashes or rainwater. Two fuel oil service tanks for each type of fuel used on board necessary for propulsion and vital systems or equivalent arrangements shall be provided on each new ship, with a capacity of at least 8 h at maximum continuous rating of the propulsion plant and normal operating load at sea of the generator plant.* This paragraph applies only to ships constructed on or after 1 July 1998.

SEE INTERPRETATION 26

Regulation 27

Machinery

1 Where risk from overspeeding of machinery exists, means shall be provided to ensure that the safe speed is not exceeded.

2 Where main or auxiliary machinery including pressure vessels or any parts of such machinery are subject to internal pressure and may be subject to dangerous overpressure, means shall be provided where practicable to protect against such excessive pressure.

3 All gearing and every shaft and coupling used for transmission of power to machinery essential for the propulsion and safety of the ship or for the safety of persons on board shall be so designed and constructed that they will withstand the maximum working stresses to which they may be subjected in all service conditions, and due consideration shall be given to the type of engines by which they are driven or of which they form part.

* Refer to regulation II-2/4.2, Arrangements for oil fuel, lubrication oil and other flammable oils.

4 Internal combustion engines of a cylinder diameter of 200 mm or a crankcase volume of 0.6 m³ and above shall be provided with crankcase explosion relief valves of a suitable type with sufficient relief area. The relief valves shall be arranged or provided with means to ensure that discharge from them is so directed as to minimize the possibility of injury to personnel.

5 Main turbine propulsion machinery and, where applicable, main internal combustion propulsion machinery and auxiliary machinery shall be provided with automatic shutoff arrangements in the case of failures such as lubricating oil supply failure which could lead rapidly to complete breakdown, serious damage or explosion. The Administration may permit provisions for overriding automatic shutoff devices.

Regulation 28

*Means of going astern**

1 Sufficient power for going astern shall be provided to secure proper control of the ship in all normal circumstances.

2 The ability of the machinery to reverse the direction of thrust of the propeller in sufficient time, and so to bring the ship to rest within a reasonable distance from maximum ahead service speed, shall be demonstrated and recorded.

3 The stopping times, ship headings and distances recorded on trials, together with the results of trials to determine the ability of ships having multiple propellers to navigate and manoeuvre with one or more propellers inoperative, shall be available on board for the use of the master or designated personnel.

SEE INTERPRETATION 27

4 Where the ship is provided with supplementary means for manoeuvring or stopping, the effectiveness of such means shall be demonstrated and recorded as referred to in paragraphs 2 and 3.

Regulation 29

Steering gear†

SEE INTERPRETATION 28

1 Unless expressly provided otherwise, every ship shall be provided with a main steering gear and an auxiliary steering gear to the satisfaction of the Administration. The main steering gear and the auxiliary steering gear shall be so arranged that the failure of one of them will not render the other one inoperative.

SEE INTERPRETATION 29

2.1 All the steering gear components and the rudder stock shall be of sound and reliable construction to the satisfaction of the Administration. Special consideration shall be given to the suitability of any essential component which is not duplicated. Any such essential component shall, where appropriate, utilize antifriction bearings such as ball-bearings, roller-bearings or sleeve-bearings which shall be permanently lubricated or provided with lubrication fittings.

SEE INTERPRETATION 30

2.2 The design pressure for calculations to determine the scantlings of piping and other steering gear components subjected to internal hydraulic pressure shall be at least 1.25 times the maximum working

* Refer to *Provision and the display of manoeuvring information on board ships* (resolution A.601(15)), *Standards for ship manoeuvrability* (resolution MSC.137(76)) and *Explanatory Notes to the Standards for ship manoeuvrability* (MSC/Circ.1053).

† Refer to *Improved steering gear standards for passenger and cargo ships* (resolution A.415(XI)) and *Examination of steering gears on existing tankers* (resolution A.416(XI)).

pressure to be expected under the operational conditions specified in paragraph 3.2, taking into account any pressure which may exist in the low-pressure side of the system. At the discretion of the Administration, fatigue criteria shall be applied for the design of piping and components, taking into account pulsating pressures due to dynamic loads.

2.3 Relief valves shall be fitted to any part of the hydraulic system which can be isolated and in which pressure can be generated from the power source or from external forces. The setting of the relief valves shall not exceed the design pressure. The valves shall be of adequate size and so arranged as to avoid an undue rise in pressure above the design pressure.

3 The main steering gear and rudder stock shall be:

- .1 of adequate strength and capable of steering the ship at maximum ahead service speed which shall be demonstrated;
- .2 capable of putting the rudder over from 35° on one side to 35° on the other side with the ship at its deepest seagoing draught and running ahead at maximum ahead service speed and, under the same conditions, from 35° on either side to 30° on the other side in not more than 28 s; where it is impractical to demonstrate compliance with this requirement during sea trials with the ship at its deepest seagoing draught and running ahead at the speed corresponding to the number of maximum continuous revolutions of the main engine and maximum design pitch, ships regardless of date of construction may demonstrate compliance with this requirement by one of the following methods:
 - .1 during sea trials the ship is at even keel and the rudder fully submerged whilst running ahead at the speed corresponding to the number of maximum continuous revolutions of the main engine and maximum design pitch; or
 - .2 where full rudder immersion during sea trials cannot be achieved, an appropriate ahead speed shall be calculated using the submerged rudder blade area in the proposed sea trial loading condition. The calculated ahead speed shall result in a force and torque applied to the main steering gear which is at least as great as if it was being tested with the ship at its deepest seagoing draught and running ahead at the speed corresponding to the number of maximum continuous revolutions of the main engine and maximum design pitch; or
 - .3 the rudder force and torque at the sea trial loading condition have been reliably predicted and extrapolated to the full load condition. The speed of the ship shall correspond to the number of maximum continuous revolutions of the main engine and maximum design pitch of the propeller;
- .3 operated by power where necessary to meet the requirements of paragraph 3.2 and in any case when the Administration requires a rudder stock of over 120 mm diameter in way of the tiller, excluding strengthening for navigation in ice; and
- .4 so designed that they will not be damaged at maximum astern speed; however, this design requirement need not be proved by trials at maximum astern speed and maximum rudder angle.

SEE INTERPRETATIONS 31 AND 32

4 The auxiliary steering gear shall be:

- .1 of adequate strength and capable of steering the ship at navigable speed and of being brought speedily into action in an emergency;
- .2 capable of putting the rudder over from 15° on one side to 15° on the other side in not more than 60 s with the ship at its deepest seagoing draught and running ahead at one half of the maximum ahead service speed or 7 knots, whichever is the greater; where it is impractical to demonstrate compliance with this requirement during sea trials with the ship at its deepest seagoing draught and running ahead at one half of the speed corresponding to the number of maximum continuous revolutions of the main engine and maximum design pitch or 7 knots, whichever is greater,

ships regardless of date of construction, including those constructed before 1 January 2009, may demonstrate compliance with this requirement by one of the following methods:

- .1 during sea trials the ship is at even keel and the rudder fully submerged whilst running ahead at one half of the speed corresponding to the number of maximum continuous revolutions of the main engine and maximum design pitch or 7 knots, whichever is greater; or
 - .2 where full rudder immersion during sea trials cannot be achieved, an appropriate ahead speed shall be calculated using the submerged rudder blade area in the proposed sea trial loading condition. The calculated ahead speed shall result in a force and torque applied to the auxiliary steering gear which is at least as great as if it was being tested with the ship at its deepest seagoing draught and running ahead at one half of the speed corresponding to the number of maximum continuous revolutions of the main engine and maximum design pitch or 7 knots, whichever is greater; or
 - .3 the rudder force and torque at the sea trial loading condition have been reliably predicted and extrapolated to the full load condition; and
- .3 operated by power where necessary to meet the requirements of paragraph 4.2 and in any case when the Administration requires a rudder stock of over 230 mm diameter in way of the tiller, excluding strengthening for navigation in ice.

SEE INTERPRETATIONS 31 AND 33

5 Main and auxiliary steering gear power units shall be:

- .1 arranged to restart automatically when power is restored after a power failure; and
- .2 capable of being brought into operation from a position on the navigation bridge. In the event of a power failure to any one of the steering gear power units, an audible and visual alarm shall be given on the navigation bridge.

6.1 Where the main steering gear comprises two or more identical power units, an auxiliary steering gear need not be fitted, provided that:

- .1 in a passenger ship, the main steering gear is capable of operating the rudder as required by paragraph 3.2 while any one of the power units is out of operation;
- .2 in a cargo ship, the main steering gear is capable of operating the rudder as required by paragraph 3.2 while operating with all power units;
- .3 the main steering gear is so arranged that after a single failure in its piping system or in one of the power units the defect can be isolated so that steering capability can be maintained or speedily regained.

SEE INTERPRETATION 34

6.2 The Administration may, until 1 September 1986, accept the fitting of a steering gear which has a proven record of reliability but does not comply with the requirements of paragraph 6.1.3 for a hydraulic system.

6.3 Steering gears, other than of the hydraulic type, shall achieve standards equivalent to the requirements of this paragraph to the satisfaction of the Administration.

7 Steering gear control shall be provided:

- .1 for the main steering gear, both on the navigation bridge and in the steering gear compartment;
- .2 where the main steering gear is arranged in accordance with paragraph 6, by two independent control systems, both operable from the navigation bridge. This does not require duplication of the steering wheel or steering lever. Where the control system consists of a hydraulic telemotor, a second independent system need not be fitted, except in a tanker, chemical tanker or gas carrier of 10,000 gross tonnage and upwards;

- .3 for the auxiliary steering gear, in the steering gear compartment and, if power-operated, it shall also be operable from the navigation bridge and shall be independent of the control system for the main steering gear.

8 Any main and auxiliary steering gear control system operable from the navigation bridge shall comply with the following:

- .1 if electric, it shall be served by its own separate circuit supplied from a steering gear power circuit from a point within the steering gear compartment, or directly from switchboard busbars supplying that steering gear power circuit at a point on the switchboard adjacent to the supply to the steering gear power circuit;
- .2 means shall be provided in the steering gear compartment for disconnecting any control system operable from the navigation bridge from the steering gear it serves;
- .3 the system shall be capable of being brought into operation from a position on the navigation bridge;
- .4 in the event of a failure of electrical power supply to the control system, an audible and visual alarm shall be given on the navigation bridge; and
- .5 short circuit protection only shall be provided for steering gear control supply circuits.

9 The electrical power circuits and the steering gear control systems with their associated components, cables and pipes required by this regulation and by regulation 30 shall be separated as far as is practicable throughout their length.

10 A means of communication shall be provided between the navigation bridge and the steering gear compartment.

11 The angular position of the rudder shall:

- .1 if the main steering gear is power-operated, be indicated on the navigation bridge. The rudder angle indication shall be independent of the steering gear control system;
- .2 be recognizable in the steering gear compartment.

12 Hydraulic power-operated steering gear shall be provided with the following:

- .1 arrangements to maintain the cleanliness of the hydraulic fluid taking into consideration the type and design of the hydraulic system;
- .2 a low-level alarm for each hydraulic fluid reservoir to give the earliest practicable indication of hydraulic fluid leakage. Audible and visual alarms shall be given on the navigation bridge and in the machinery space where they can be readily observed; and
- .3 a fixed storage tank having sufficient capacity to recharge at least one power actuating system including the reservoir, where the main steering gear is required to be power-operated. The storage tank shall be permanently connected by piping in such a manner that the hydraulic systems can be readily recharged from a position within the steering gear compartment and shall be provided with a contents gauge.

13 The steering gear compartments shall be:

- .1 readily accessible and, as far as practicable, separated from machinery spaces; and
- .2 provided with suitable arrangements to ensure working access to steering gear machinery and controls. These arrangements shall include handrails and gratings or other nonslip surfaces to ensure suitable working conditions in the event of hydraulic fluid leakage.

14 Where the rudder stock is required to be over 230 mm diameter in way of the tiller, excluding strengthening for navigation in ice, an alternative power supply, sufficient at least to supply the steering gear power unit which complies with the requirements of paragraph 4.2 and also its associated control system and the rudder angle indicator, shall be provided automatically, within 45 s, either from the emergency source of electrical power or from an independent source of power located in the steering gear compartment. This independent source of power shall be used only for this purpose. In every ship of 10,000 gross tonnage and upwards, the alternative power supply shall have a capacity for at least 30 min of continuous operation and in any other ship for at least 10 min.

SEE INTERPRETATION 35

15 In every tanker, chemical tanker or gas carrier of 10,000 gross tonnage and upwards and in every other ship of 70,000 gross tonnage and upwards, the main steering gear shall comprise two or more identical power units complying with the provisions of paragraph 6.

16 Every tanker, chemical tanker or gas carrier of 10,000 gross tonnage and upwards shall, subject to paragraph 17, comply with the following:

- .1** the main steering gear shall be so arranged that in the event of loss of steering capability due to a single failure in any part of one of the power actuating systems of the main steering gear, excluding the tiller, quadrant or components serving the same purpose, or seizure of the rudder actuators, steering capability shall be regained in not more than 45 s after the loss of one power actuating system;
- .2** the main steering gear shall comprise either:
 - .1** two independent and separate power actuating systems, each capable of meeting the requirements of paragraph 3.2; or
 - .2** at least two identical power actuating systems which, acting simultaneously in normal operation, shall be capable of meeting the requirements of paragraph 3.2. Where necessary to comply with this requirement, interconnection of hydraulic power actuating systems shall be provided. Loss of hydraulic fluid from one system shall be capable of being detected and the defective system automatically isolated so that the other actuating system or systems shall remain fully operational;
- .3** steering gears other than of the hydraulic type shall achieve equivalent standards.

17 For tankers, chemical tankers or gas carriers of 10,000 gross tonnage and upwards, but of less than 100,000 tonnes deadweight, solutions other than those set out in paragraph 16, which need not apply the single failure criterion to the rudder actuator or actuators, may be permitted provided that an equivalent safety standard is achieved and that:

- .1** following loss of steering capability due to a single failure of any part of the piping system or in one of the power units, steering capability shall be regained within 45 s; and
- .2** where the steering gear includes only a single rudder actuator, special consideration is given to stress analysis for the design including fatigue analysis and fracture mechanics analysis, as appropriate, to the material used, to the installation of sealing arrangements and to testing and inspection and to the provision of effective maintenance. In consideration of the foregoing, the Administration shall adopt regulations which include the provisions of the Guidelines for acceptance of non-duplicated rudder actuators for tankers, chemical tankers and gas carriers of 10,000 gross tonnage and above but less than 100,000 tonnes deadweight, adopted by the Organization.*

18 For a tanker, chemical tanker or gas carrier of 10,000 gross tonnage and upwards, but less than 70,000 tonnes deadweight, the Administration may, until 1 September 1986, accept a steering gear system with a proven record of reliability which does not comply with the single failure criterion required for a hydraulic system in paragraph 16.

* Refer to *Guidelines for acceptance of non-duplicated rudder actuators for tankers, chemical tankers and gas carriers of 10,000 tons gross tonnage and above but less than 100,000 tons deadweight* (resolution A.467(XII)).

19 Every tanker, chemical tanker or gas carrier of 10,000 gross tonnage and upwards, constructed before 1 September 1984, shall comply, not later than 1 September 1986, with the following:

- .1 the requirements of paragraphs 7.1, 8.2, 8.4, 10, 11, 12.2, 12.3 and 13.2;
- .2 two independent steering gear control systems shall be provided each of which can be operated from the navigation bridge. This does not require duplication of the steering wheel or steering lever;
- .3 if the steering gear control system in operation fails, the second system shall be capable of being brought into immediate operation from the navigation bridge; and
- .4 each steering gear control system, if electric, shall be served by its own separate circuit supplied from the steering gear power circuit or directly from switchboard busbars supplying that steering gear power circuit at a point on the switchboard adjacent to the supply to the steering gear power circuit.

20 In addition to the requirements of paragraph 19, in every tanker, chemical tanker or gas carrier of 40,000 gross tonnage and upwards, constructed before 1 September 1984, the steering gear shall, not later than 1 September 1988, be so arranged that, in the event of a single failure of the piping or of one of the power units, steering capability can be maintained or the rudder movement can be limited so that steering capability can be speedily regained. This shall be achieved by:

- .1 an independent means of restraining the rudder; or
- .2 fast-acting valves which may be manually operated to isolate the actuator or actuators from the external hydraulic piping together with a means of directly refilling the actuators by a fixed independent power-operated pump and piping system; or
- .3 an arrangement such that, where hydraulic power systems are interconnected, loss of hydraulic fluid from one system shall be detected and the defective system isolated either automatically or from the navigation bridge so that the other system remains fully operational.

Regulation 30

Additional requirements for electric and electrohydraulic steering gear

1 Means for indicating that the motors of electric and electrohydraulic steering gear are running shall be installed on the navigation bridge and at a suitable main machinery control position.

2 Each electric or electrohydraulic steering gear comprising one or more power units shall be served by at least two exclusive circuits fed directly from the main switchboard; however, one of the circuits may be supplied through the emergency switchboard. An auxiliary electric or electrohydraulic steering gear associated with a main electric or electrohydraulic steering gear may be connected to one of the circuits supplying this main steering gear. The circuits supplying an electric or electrohydraulic steering gear shall have adequate rating for supplying all motors which can be simultaneously connected to them and may be required to operate simultaneously.

SEE INTERPRETATION 36

3 Short circuit protection and an overload alarm shall be provided for such circuits and motors. Protection against excess current, including starting current, if provided, shall be for not less than twice the full load current of the motor or circuit so protected, and shall be arranged to permit the passage of the appropriate starting currents. Where a three-phase supply is used an alarm shall be provided that will indicate failure of any one of the supply phases. The alarms required in this paragraph shall be both audible and visual and shall be situated in a conspicuous position in the main machinery space or control room from which the main machinery is normally controlled and as may be required by regulation 51.

4 When in a ship of less than 1,600 gross tonnage an auxiliary steering gear which is required by regulation 29.4.3 to be operated by power is not electrically powered or is powered by an electric motor primarily intended for other services, the main steering gear may be fed by one circuit from the main switchboard. Where such an electric motor primarily intended for other services is arranged to power such an auxiliary steering gear, the requirement of paragraph 3 may be waived by the Administration if satisfied with the protection arrangement together with the requirements of regulation 29.5.1 and .2 and 29.7.3 applicable to auxiliary steering gear.

Regulation 31

Machinery controls

1 Main and auxiliary machinery essential for the propulsion and safety of the ship shall be provided with effective means for its operation and control.

2 Where remote control of propulsion machinery from the navigation bridge is provided and the machinery spaces are intended to be manned, the following shall apply:

- .1 the speed, direction of thrust and, if applicable, the pitch of the propeller shall be fully controllable from the navigation bridge under all sailing conditions, including manoeuvring;
- .2 the remote control shall be performed, for each independent propeller, by a control device so designed and constructed that its operation does not require particular attention to the operational details of the machinery. Where multiple propellers are designed to operate simultaneously, they may be controlled by one control device;
- .3 the main propulsion machinery shall be provided with an emergency stopping device on the navigation bridge which shall be independent of the navigation bridge control system;
- .4 propulsion machinery orders from the navigation bridge shall be indicated in the main machinery control room or at the manoeuvring platform as appropriate;
- .5 remote control of the propulsion machinery shall be possible only from one location at a time; at such locations interconnected control positions are permitted. At each location there shall be an indicator showing which location is in control of the propulsion machinery. The transfer of control between the navigation bridge and machinery spaces shall be possible only in the main machinery space or the main machinery control room. This system shall include means to prevent the propelling thrust from altering significantly when transferring control from one location to another;
- .6 it shall be possible to control the propulsion machinery locally, even in the case of failure in any part of the remote control system;
- .7 the design of the remote control system shall be such that in case of its failure an alarm will be given. Unless the Administration considers it impracticable the preset speed and direction of thrust of the propellers shall be maintained until local control is in operation;
- .8 indicators shall be fitted on the navigation bridge for:
 - .1 propeller speed and direction of rotation in the case of fixed pitch propellers;
 - .2 propeller speed and pitch position in the case of controllable pitch propellers;
- .9 an alarm shall be provided on the navigation bridge and in the machinery space to indicate low starting air pressure which shall be set at a level to permit further main engine starting operations. If the remote control system of the propulsion machinery is designed for automatic starting, the number of automatic consecutive attempts which fail to produce a start shall be limited in order to safeguard sufficient starting air pressure for starting locally.

3 Where the main propulsion and associated machinery, including sources of main electrical supply, are provided with various degrees of automatic or remote control and are under continuous manual supervision from a control room the arrangements and controls shall be so designed, equipped and installed that the machinery operation will be as safe and effective as if it were under direct supervision; for this purpose regulations 46 to 50 shall apply as appropriate. Particular consideration shall be given to protect such spaces against fire and flooding.

4 In general, automatic starting, operational and control systems shall include provisions for manually overriding the automatic controls. Failure of any part of such systems shall not prevent the use of the manual override.

5 Ships constructed on or after 1 July 1998 shall comply with the requirements of paragraphs 1 to 4, as amended, as follows:

- .1 paragraph 1 is replaced by the following:
 - "1 Main and auxiliary machinery essential for the propulsion, control and safety of the ship shall be provided with effective means for its operation and control. All control systems essential for the propulsion, control and safety of the ship shall be independent or designed such that failure of one system does not degrade the performance of another system.";
- .2 in the second and third lines of paragraph 2, the words "and the machinery spaces are intended to be manned" are deleted;
- .3 the first sentence of paragraph 2.2 is replaced by the following:
 - ".2 the control shall be performed by a single control device for each independent propeller, with automatic performance of all associated services, including, where necessary, means of preventing overload of the propulsion machinery.";
- .4 paragraph 2.4 is replaced by the following:
 - ".4 propulsion machinery orders from the navigation bridge shall be indicated in the main machinery control room and at the manoeuvring platform.";
- .5 a new sentence is added at the end of paragraph 2.6 to read as follows:

"It shall also be possible to control the auxiliary machinery, essential for the propulsion and safety of the ship, at or near the machinery concerned."; and
- .6 paragraphs 2.8, 2.8.1 and 2.8.2 are replaced by the following:
 - ".8 indicators shall be fitted on the navigation bridge, the main machinery control room and at the manoeuvring platform, for:
 - .1 propeller speed and direction of rotation in the case of fixed pitch propellers; and
 - .2 propeller speed and pitch position in the case of controllable pitch propellers;"

6 Ships constructed on or after 1 July 2004 shall comply with the requirements of paragraphs 1 to 5, as amended, as follows:

- .1 a new subparagraph .10 is added to paragraph 2 to read as follows:
 - ".10 automation systems shall be designed in a manner which ensures that threshold warning of impending or imminent slowdown or shutdown of the propulsion system is given to the officer in charge of the navigational watch in time to assess navigational circumstances in an emergency. In particular, the systems shall control, monitor, report, alert and take safety action to slow down or stop propulsion while providing the officer in charge of the navigational watch an opportunity to manually intervene, except for those cases where manual intervention will result in total failure of the engine and/or propulsion equipment within a short time, for example in the case of overspeed."

Regulation 32

Steam boilers and boiler feed systems

1 Every steam boiler and every unfired steam generator shall be provided with not less than two safety valves of adequate capacity. However, having regard to the output or any other features of any boiler or unfired steam generator, the Administration may permit only one safety valve to be fitted if it is satisfied that adequate protection against overpressure is thereby provided.

2 Each oil-fired boiler which is intended to operate without manual supervision shall have safety arrangements which shut off the fuel supply and give an alarm in the case of low water level, air supply failure or flame failure.

- 3 Water tube boilers serving turbine propulsion machinery shall be fitted with a high water level alarm.
- 4 Every steam generating system which provides services essential for the safety of the ship, or which could be rendered dangerous by the failure of its feedwater supply, shall be provided with not less than two separate feedwater systems from and including the feed pumps, noting that a single penetration of the steam drum is acceptable. Unless overpressure is prevented by the pump characteristics, means shall be provided which will prevent overpressure in any part of the systems.
- 5 Boilers shall be provided with means to supervise and control the quality of the feedwater. Suitable arrangements shall be provided to preclude, as far as practicable, the entry of oil or other contaminants which may adversely affect the boiler.
- 6 Every boiler essential for the safety of the ship and designed to contain water at a specified level shall be provided with at least two means for indicating its water level, at least one of which shall be a direct reading gauge glass.

Regulation 33

Steam pipe systems

- 1 Every steam pipe and every fitting connected thereto through which steam may pass shall be so designed, constructed and installed as to withstand the maximum working stresses to which it may be subjected.
- 2 Means shall be provided for draining every steam pipe in which dangerous water hammer action might otherwise occur.
- 3 If a steam pipe or fitting may receive steam from any source at a higher pressure than that for which it is designed a suitable reducing valve, relief valve and pressure gauge shall be fitted.

Regulation 34

Air pressure systems

- 1 In every ship means shall be provided to prevent overpressure in any part of compressed air systems and wherever water jackets or casings of air compressors and coolers might be subjected to dangerous overpressure due to leakage into them from air pressure parts. Suitable pressure relief arrangements shall be provided for all systems.
- 2 The main starting air arrangements for main propulsion internal combustion engines shall be adequately protected against the effects of backfiring and internal explosion in the starting air pipes.
- 3 All discharge pipes from starting air compressors shall lead directly to the starting air receivers, and all starting pipes from the air receivers to main or auxiliary engines shall be entirely separate from the compressor discharge pipe system.
- 4 Provision shall be made to reduce to a minimum the entry of oil into the air pressure systems and to drain these systems.

Regulation 35

Ventilating systems in machinery spaces

Machinery spaces of category A shall be adequately ventilated so as to ensure that when machinery or boilers therein are operating at full power in all weather conditions including heavy weather, an adequate supply of air is maintained to the spaces for the safety and comfort of personnel and the operation of the machinery. Any other machinery space shall be adequately ventilated appropriate for the purpose of that machinery space.

Regulation 35-1

Bilge pumping arrangements

1 This regulation applies to ships constructed on or after 1 January 2009.

2 Passenger ships and cargo ships

2.1 An efficient bilge pumping system shall be provided, capable of pumping from and draining any watertight compartment other than a space permanently appropriated for the carriage of fresh water, water ballast, oil fuel or liquid cargo and for which other efficient means of pumping are provided, under all practical conditions. Efficient means shall be provided for draining water from insulated holds.

2.2 Sanitary, ballast and general service pumps may be accepted as independent power bilge pumps if fitted with the necessary connections to the bilge pumping system.

2.3 All bilge pipes used in or under coal bunkers or fuel storage tanks or in boiler or machinery spaces, including spaces in which oil-settling tanks or oil fuel pumping units are situated, shall be of steel or other suitable material.

2.4 The arrangement of the bilge and ballast pumping system shall be such as to prevent the possibility of water passing from the sea and from water ballast spaces into the cargo and machinery spaces, or from one compartment to another. Provision shall be made to prevent any deep tank having bilge and ballast connections being inadvertently flooded from the sea when containing cargo, or being discharged through a bilge pump when containing water ballast.

2.5 All distribution boxes and manually operated valves in connection with the bilge pumping arrangements shall be in positions which are accessible under ordinary circumstances.

2.6 Provision shall be made for the drainage of enclosed cargo spaces situated on the bulkhead deck of a passenger ship and on the freeboard deck of a cargo ship, provided that the Administration may permit the means of drainage to be dispensed with in any particular compartment of any ship or class of ship if it is satisfied that by reason of size or internal subdivision of those spaces the safety of the ship is not thereby impaired. For ships subject to the provisions of regulation II-1/1.1.1.1, for the special hazards associated with loss of stability when fitted with fixed pressure water-spraying fire-extinguishing systems refer to regulation II-2/20.6.1.4.

2.6.1 Where the freeboard to the bulkhead deck or the freeboard deck, respectively, is such that the deck edge is immersed when the ship heels more than 5°, the drainage shall be by means of a sufficient number of scuppers of suitable size discharging directly overboard, fitted in accordance with the requirements of regulation 15 in the case of a passenger ship and the requirements for scuppers, inlets and discharges of the International Convention on Load Lines in force in the case of a cargo ship.

SEE INTERPRETATION 37

2.6.2 Where the freeboard is such that the edge of the bulkhead deck or the edge of the freeboard deck, respectively, is immersed when the ship heels 5° or less, the drainage of the enclosed cargo spaces on the bulkhead deck or on the freeboard deck, respectively, shall be led to a suitable space, or spaces, of adequate capacity, having a high water level alarm and provided with suitable arrangements for discharge overboard. In addition it shall be ensured that:

- .1 the number, size and disposition of the scuppers are such as to prevent unreasonable accumulation of free water;
- .2 the pumping arrangements required by this regulation for passenger ships or cargo ships, as applicable, take account of the requirements for any fixed pressure water-spraying fire-extinguishing system;
- .3 water contaminated with petrol or other dangerous substances is not drained to machinery spaces or other spaces where sources of ignition may be present; and
- .4 where the enclosed cargo space is protected by a carbon dioxide fire-extinguishing system the deck scuppers are fitted with means to prevent the escape of the smothering gas.

2.6.3 Provisions for the drainage of closed vehicle and ro-ro spaces and special category spaces shall also comply with regulations II-2/20.6.1.4 and II-2/20.6.1.5.

3 Passenger ships

3.1 The bilge pumping system required by paragraph 2.1 shall be capable of operation under all practicable conditions after a casualty whether the ship is upright or listed. For this purpose wing suction shall generally be fitted except in narrow compartments at the end of the ship where one suction may be sufficient. In compartments of unusual form, additional suction may be required. Arrangements shall be made whereby water in the compartment may find its way to the suction pipes. Where, for particular compartments, the Administration is satisfied that the provision of drainage may be undesirable, it may allow such provision to be dispensed with if calculations made in accordance with the conditions laid down in regulations 7 and 8 show that the survival capability of the ship will not be impaired.

3.2 At least three power pumps shall be fitted connected to the bilge main, one of which may be driven by the propulsion machinery. Where the bilge pump numeral is 30 or more, one additional independent power pump shall be provided.

The bilge pump numeral shall be calculated as follows:

$$\text{when } P_1 \text{ is greater than } P: \text{ bilge pump numeral} = 72 \cdot \left(\frac{M + 2P_1}{V + P_1 - P} \right)$$

$$\text{in other cases: bilge pump numeral} = 72 \cdot \left(\frac{M + 2P}{V} \right)$$

where:

- L = the length of the ship (metres), as defined in regulation 2;
- M = the volume of the machinery space (cubic metres), as defined in regulation 2, that is below the bulkhead deck; with the addition thereto of the volume of any permanent oil fuel bunkers which may be situated above the inner bottom and forward of, or abaft, the machinery space;
- P = the whole volume of the passenger and crew spaces below the bulkhead deck (cubic metres) which are provided for the accommodation and use of passengers and crew, excluding baggage, store and provision rooms;
- V = the whole volume of the ship below the bulkhead deck (cubic metres);
- $P_1 = KN$,
where:
 N = the number of passengers for which the ship is to be certified; and
 $K = 0.056L$

However, where the value of KN is greater than the sum of P and the whole volume of the actual passenger spaces above the bulkhead deck, the figure to be taken as P_1 is that sum or two-thirds KN , whichever is the greater.

3.3 Where practicable, the power bilge pumps shall be placed in separate watertight compartments and so arranged or situated that these compartments will not be flooded by the same damage. If the main propulsion machinery, auxiliary machinery and boilers are in two or more watertight compartments, the pumps available for bilge service shall be distributed as far as is possible throughout these compartments.

3.4 On a ship of 91.5 m in length L and upwards or having a bilge pump numeral, calculated in accordance with paragraph 3.2, of 30 or more, the arrangements shall be such that at least one power bilge pump shall be available for use in all flooding conditions which the ship is required to withstand, and, for ships subject to the provisions of regulation II-1/1.1.1.1, in all flooding conditions derived from consideration of minor damages as specified in regulation 8 as follows:

- .1 one of the required bilge pumps shall be an emergency pump of a reliable submersible type having a source of power situated above the bulkhead deck; or
- .2 the bilge pumps and their sources of power shall be so distributed throughout the length of the ship that at least one pump in an undamaged compartment will be available.

3.5 With the exception of additional pumps which may be provided for peak compartments only, each required bilge pump shall be so arranged as to draw water from any space required to be drained by paragraph 2.1.

3.6 Each power bilge pump shall be capable of pumping water through the required main bilge pipe at a speed of not less than 2 m/s. Independent power bilge pumps situated in machinery spaces shall have direct suction from these spaces, except that not more than two such suction shall be required in any one space. Where two or more such suction are provided, there shall be at least one on each side of the ship. The Administration may require independent power bilge pumps situated in other spaces to have separate direct suction. Direct suction shall be suitably arranged and those in a machinery space shall be of a diameter not less than that required for the bilge main.

3.7.1 In addition to the direct bilge suction or suction required by paragraph 3.6, a direct suction from the main circulating pump leading to the drainage level of the machinery space and fitted with a non-return valve shall be provided in the machinery space. The diameter of this direct suction pipe shall be at least two thirds of the diameter of the pump inlet in the case of steamships, and of the same diameter as the pump inlet in the case of motorships.

3.7.2 Where, in the opinion of the Administration, the main circulating pump is not suitable for this purpose, a direct emergency bilge suction shall be led from the largest available independent power-driven pump to the drainage level of the machinery space; the suction shall be of the same diameter as the main inlet of the pump used. The capacity of the pump so connected shall exceed that of a required bilge pump by an amount deemed satisfactory by the Administration.

3.7.3 The spindles of the sea inlet and direct suction valves shall extend well above the engine-room platform.

3.8 All bilge suction piping up to the connection to the pumps shall be independent of other piping.

3.9 The diameter d of the bilge main shall be calculated according to the following formula. However, the actual internal diameter of the bilge main may be rounded off to the nearest standard size acceptable to the Administration:

$$d = 25 + 1.68\sqrt{L(B + D)}$$

where:

d is the internal diameter of the bilge main (millimetres);

L and B are the length and the breadth of the ship (metres) as defined in regulation 2; and

D is the moulded depth of the ship to the bulkhead deck (metres) provided that, in a ship having an enclosed cargo space on the bulkhead deck which is internally drained in accordance with the requirements of paragraph 2.6.2 and which extends for the full length of the ship, D shall be measured to the next deck above the bulkhead deck. Where the enclosed cargo spaces cover a lesser length, D shall be taken as the moulded depth to the bulkhead deck plus lh/L where l and h are the aggregate length and height, respectively, of the enclosed cargo spaces (metres). The diameter of the bilge branch pipes shall meet the requirements of the Administration.

3.10 Provision shall be made to prevent the compartment served by any bilge suction pipe being flooded in the event of the pipe being severed or otherwise damaged by collision or grounding in any other compartment. For this purpose, where the pipe is at any part situated nearer the side of the ship than one fifth of the breadth of the ship (as defined in regulation 2 and measured at right angles to the centreline at the level of the deepest subdivision load line), or is in a duct keel, a non-return valve shall be fitted to the pipe in the compartment containing the open end. For ships subject to the provisions of regulation II-1/1.1.1.1, the deepest subdivision load line shall be taken as the deepest subdivision draught.

3.11 Distribution boxes, cocks and valves in connection with the bilge pumping system shall be so arranged that, in the event of flooding, one of the bilge pumps may be operative on any compartment; in addition, damage to a pump or its pipe connecting to the bilge main outboard of a line drawn at one fifth of the breadth of the ship shall not put the bilge system out of action. If there is only one system of pipes common to all the pumps, the necessary valves for controlling the bilge suction must be capable of being operated from

above the bulkhead deck. Where, in addition to the main bilge pumping system, an emergency bilge pumping system is provided, it shall be independent of the main system and so arranged that a pump is capable of operating on any compartment under flooding condition as specified in paragraph 3.1; in that case only the valves necessary for the operation of the emergency system need be capable of being operated from above the bulkhead deck.

3.12 All cocks and valves referred to in paragraph 3.11 which can be operated from above the bulkhead deck shall have their controls at their place of operation clearly marked and shall be provided with means to indicate whether they are open or closed.

4 Cargo ships

At least two power pumps connected to the main bilge system shall be provided, one of which may be driven by the propulsion machinery. If the Administration is satisfied that the safety of the ship is not impaired, bilge pumping arrangements may be dispensed with in particular compartments.

Regulation 36*

Regulation 37

Communication between navigation bridge and machinery space

1 At least two independent means shall be provided for communicating orders from the navigation bridge to the position in the machinery space or in the control room from which the engines are normally controlled: one of these shall be an engine-room telegraph which provides visual indication of the orders and responses both in the machinery space and on the navigation bridge. Appropriate means of communication shall be provided to any other positions from which the engines may be controlled.

2 For ships constructed on or after 1 October 1994 the following requirements apply in lieu of the provisions of paragraph 1:

At least two independent means shall be provided for communicating orders from the navigation bridge to the position in the machinery space or in the control room from which the speed and direction of thrust of the propellers are normally controlled; one of these shall be an engine-room telegraph which provides visual indication of the orders and responses both in the machinery spaces and on the navigation bridge. Appropriate means of communication shall be provided from the navigation bridge and the engine-room to any other position from which the speed or direction of thrust of the propellers may be controlled.

Regulation 38

Engineers' alarm

An engineers' alarm shall be provided to be operated from the engine control room or at the manoeuvring platform as appropriate, and shall be clearly audible in the engineers' accommodation.

Regulation 39

Location of emergency installations in passenger ships

Emergency sources of electrical power, fire pumps, bilge pumps except those specifically serving the spaces forward of the collision bulkhead, any fixed fire-extinguishing system required by chapter II-2 and other emergency installations which are essential for the safety of the ship, except anchor windlasses, shall not be installed forward of the collision bulkhead.

* This regulation is deliberately left blank.

Part D

Electrical installations

(Except where expressly provided otherwise part D applies to passenger ships and cargo ships)

Regulation 40

General

SEE INTERPRETATION 38

- 1 Electrical installations shall be such that:
 - .1 all electrical auxiliary services necessary for maintaining the ship in normal operational and habitable conditions will be ensured without recourse to the emergency source of electrical power;
 - .2 electrical services essential for safety will be ensured under various emergency conditions; and
 - .3 the safety of passengers, crew and ship from electrical hazards will be ensured.
- 2 The Administration shall take appropriate steps to ensure uniformity in the implementation and application of the provisions of this part in respect of electrical installations.*

Regulation 41

Main source of electrical power and lighting systems

SEE INTERPRETATION 38

- 1.1 A main source of electrical power of sufficient capacity to supply all those services mentioned in regulation 40.1.1 shall be provided. This main source of electrical power shall consist of at least two generating sets.
- 1.2 The capacity of these generating sets shall be such that in the event of any one generating set being stopped it will still be possible to supply those services necessary to provide normal operational conditions of propulsion and safety. Minimum comfortable conditions of habitability shall also be ensured which include at least adequate services for cooking, heating, domestic refrigeration, mechanical ventilation, sanitary and fresh water.

SEE INTERPRETATION 39

- 1.3 The arrangements of the ship's main source of electrical power shall be such that the services referred to in regulation 40.1.1 can be maintained regardless of the speed and direction of rotation of the propulsion machinery or shafting.

SEE INTERPRETATION 40

- 1.4 In addition, the generating sets shall be such as to ensure that with any one generator or its primary source of power out of operation, the remaining generating sets shall be capable of providing the electrical services necessary to start the main propulsion plant from a dead ship condition. The emergency source of

* Refer to the recommendations published by the International Electrotechnical Commission and, in particular, publication IEC 60092, *Electrical installations in ships*.

electrical power may be used for the purpose of starting from a dead ship condition if its capability either alone or combined with that of any other source of electrical power is sufficient to provide at the same time those services required to be supplied by regulations 42.2.1 to 42.2.3 or 43.2.1 to 43.2.4.

1.5 Where transformers constitute an essential part of the electrical supply system required by this paragraph, the system shall be so arranged as to ensure the same continuity of the supply as is stated in this paragraph.

2.1 A main electric lighting system which shall provide illumination throughout those parts of the ship normally accessible to and used by passengers or crew shall be supplied from the main source of electrical power.

2.2 The arrangement of the main electric lighting system shall be such that a fire or other casualty in spaces containing the main source of electrical power, associated transforming equipment, if any, the main switchboard and the main lighting switchboard, will not render the emergency electric lighting system required by regulations 42.2.1 and 42.2.2 or 43.2.1, 43.2.2 and 43.2.3 inoperative.

2.3 The arrangement of the emergency electric lighting system shall be such that a fire or other casualty in spaces containing the emergency source of electrical power, associated transforming equipment, if any, the emergency switchboard and the emergency lighting switchboard will not render the main electric lighting system required by this regulation inoperative.

3 The main switchboard shall be so placed relative to one main generating station that, as far as is practicable, the integrity of the normal electrical supply may be affected only by a fire or other casualty in one space. An environmental enclosure for the main switchboard, such as may be provided by a machinery control room situated within the main boundaries of the space, is not to be considered as separating the switchboards from the generators.

4 Where the total installed electrical power of the main generating sets is in excess of 3 MW, the main busbars shall be subdivided into at least two parts which shall normally be connected by removable links or other approved means; so far as is practicable, the connection of generating sets and any other duplicated equipment shall be equally divided between the parts. Equivalent arrangements may be permitted to the satisfaction of the Administration.

5 Ships constructed on or after 1 July 1998:

.1 in addition to paragraphs 1 to 3, shall comply with the following:

.1 where the main source of electrical power is necessary for propulsion and steering of the ship, the system shall be so arranged that the electrical supply to equipment necessary for propulsion and steering and to ensure safety of the ship will be maintained or immediately restored in the case of loss of any one of the generators in service;

SEE INTERPRETATION 41

.2 load shedding or other equivalent arrangements shall be provided to protect the generators required by this regulation against sustained overload;

SEE INTERPRETATION 42

.3 where the main source of electrical power is necessary for propulsion of the ship, the main busbar shall be subdivided into at least two parts which shall normally be connected by circuit breakers or other approved means; so far as is practicable, the connection of generating sets and other duplicated equipment shall be equally divided between the parts; and

SEE INTERPRETATION 43

.2 need not comply with paragraph 4.

6 In passenger ships constructed on or after 1 July 2010, supplementary lighting shall be provided in all cabins to clearly indicate the exit so that occupants will be able to find their way to the door. Such lighting, which may be connected to an emergency source of power or have a self-contained source of electrical

power in each cabin, shall automatically illuminate when power to the normal cabin lighting is lost and remain on for a minimum of 30 min.

Regulation 42

Emergency source of electrical power in passenger ships

SEE INTERPRETATION 44

(Paragraphs 2.6.1 and 4.2 of this regulation apply to ships constructed on or after 1 February 1992)

1.1 A self-contained emergency source of electrical power shall be provided.

1.2 The emergency source of electrical power, associated transforming equipment, if any, transitional source of emergency power, emergency switchboard and emergency lighting switchboard shall be located above the uppermost continuous deck and shall be readily accessible from the open deck. They shall not be located forward of the collision bulkhead.

1.3 The location of the emergency source of electrical power and associated transforming equipment, if any, the transitional source of emergency power, the emergency switchboard and the emergency electric lighting switchboards in relation to the main source of electrical power, associated transforming equipment, if any, and the main switchboard shall be such as to ensure to the satisfaction of the Administration that a fire or other casualty in spaces containing the main source of electrical power, associated transforming equipment, if any, and the main switchboard or in any machinery space of category A will not interfere with the supply, control and distribution of emergency electrical power. As far as practicable, the space containing the emergency source of electrical power, associated transforming equipment, if any, the transitional source of emergency electrical power and the emergency switchboard shall not be contiguous to the boundaries of machinery spaces of category A or those spaces containing the main source of electrical power, associated transforming equipment, if any, or the main switchboard.

1.4 Provided that suitable measures are taken for safeguarding independent emergency operation under all circumstances, the emergency generator may be used exceptionally, and for short periods, to supply non-emergency circuits.

2 The electrical power available shall be sufficient to supply all those services that are essential for safety in an emergency, due regard being paid to such services as may have to be operated simultaneously. The emergency source of electrical power shall be capable, having regard to starting currents and the transitory nature of certain loads, of supplying simultaneously at least the following services for the periods specified hereinafter, if they depend upon an electrical source for their operation:

2.1 For a period of 36 h, emergency lighting:

- .1** at every muster and embarkation station and over the sides as required by regulations III/11.4 and III/16.7;
- .2** in alleyways, stairways and exits giving access to the muster and embarkation stations, as required by regulation III/11.5;
- .3** in all service and accommodation alleyways, stairways and exits, personnel lift cars;
- .4** in the machinery spaces and main generating stations including their control positions;
- .5** in all control stations, machinery control rooms, and at each main and emergency switchboard;
- .6** at all stowage positions for firemen's outfits;
- .7** at the steering gear; and
- .8** at the fire pump, the sprinkler pump and the emergency bilge pump referred to in paragraph 2.4 and at the starting position of their motors.

2.2 For a period of 36 h:

- .1 the navigation lights and other lights required by the International Regulations for Preventing Collisions at Sea in force; and
- .2 on ships constructed on or after 1 February 1995, the VHF radio installation required by regulation IV/7.1.1 and IV/7.1.2; and, if applicable:
 - .1 the MF radio installation required by regulations IV/9.1.1, IV/9.1.2, IV/10.1.2 and IV/10.1.3;
 - .2 the ship earth station required by regulation IV/10.1.1; and
 - .3 the MF/HF radio installation required by regulations IV/10.2.1, IV/10.2.2 and IV/11.1.

2.3 For a period of 36 h:

- .1 all internal communication equipment required in an emergency;
- .2 the shipborne navigational equipment as required by regulation V/19; where such provision is unreasonable or impracticable the Administration may waive this requirement for ships of less than 5,000 gross tonnage;
- .3 the fire detection and fire alarm system, and the fire door holding and release system; and
- .4 for intermittent operation of the daylight signalling lamp, the ship's whistle, the manually operated call points, and all internal signals that are required in an emergency;

unless such services have an independent supply for the period of 36 h from an accumulator battery suitably located for use in an emergency.

2.4 For a period of 36 h:

- .1 one of the fire pumps required by regulations II-2/10.2.2.2 and II-2/10.2.2.3;
- .2 the automatic sprinkler pump, if any; and
- .3 the emergency bilge pump and all the equipment essential for the operation of electrically powered remote controlled bilge valves.

2.5 For the period of time required by regulation 29.14 the steering gear if required to be so supplied by that regulation.

2.6 For a period of half an hour:

- .1 any watertight doors required by regulation 15 to be power-operated together with their indicators and warning signals;
- .2 the emergency arrangements to bring the lift cars to deck level for the escape of persons. The passenger lift cars may be brought to deck level sequentially in an emergency.

2.7 In a ship engaged regularly on voyages of short duration, the Administration if satisfied that an adequate standard of safety would be attained may accept a lesser period than the 36 h period specified in paragraphs 2.1 to 2.5 but not less than 12 h.

3 The emergency source of electrical power may be either a generator or an accumulator battery, which shall comply with the following:

3.1 Where the emergency source of electrical power is a generator, it shall be:

- .1 driven by a suitable prime mover with an independent supply of fuel having a flashpoint (closed-cup test) of not less than 43°C;
- .2 started automatically upon failure of the electrical supply from the main source of electrical power and shall be automatically connected to the emergency switchboard; those services referred to in paragraph 4 shall then be transferred automatically to the emergency generating set. The automatic starting system and the characteristic of the prime mover shall be such as to permit the emergency generator to carry its full rated load as quickly as is safe and practicable, subject to a maximum of 45 s; unless a second independent means of starting the emergency generating set is provided,

- the single source of stored energy shall be protected to preclude its complete depletion by the automatic starting system; and
- .3 provided with a transitional source of emergency electrical power according to paragraph 4.
- 3.2** Where the emergency source of electrical power is an accumulator battery, it shall be capable of:
- .1 carrying the emergency electrical load without recharging while maintaining the voltage of the battery throughout the discharge period within 12% above or below its nominal voltage;
 - .2 automatically connecting to the emergency switchboard in the event of failure of the main source of electrical power; and
 - .3 immediately supplying at least those services specified in paragraph 4.
- 3.3** The following provisions in paragraph 3.1.2 shall not apply to ships constructed on or after 1 October 1994: Unless a second independent means of starting the emergency generating set is provided, the single source of stored energy shall be protected to preclude its complete depletion by the automatic starting system.
- 3.4** For ships constructed on or after 1 July 1998, where electrical power is necessary to restore propulsion, the capacity shall be sufficient to restore propulsion to the ship in conjunction with other machinery, as appropriate, from a dead ship condition within 30 min after blackout.
- 4** The transitional source of emergency electrical power required by paragraph 3.1.3 shall consist of an accumulator battery suitably located for use in an emergency which shall operate without recharging while maintaining the voltage of the battery throughout the discharge period within 12% above or below its nominal voltage and be of sufficient capacity and so arranged as to supply automatically in the event of failure of either the main or emergency source of electrical power at least the following services, if they depend upon an electrical source for their operation:
- 4.1** For half an hour:
 - .1 the lighting required by paragraphs 2.1 and 2.2;
 - .2 all services required by paragraphs 2.3.1, 2.3.3 and 2.3.4 unless such services have an independent supply for the period specified from an accumulator battery suitably located for use in an emergency.
 - 4.2** Power to operate the watertight doors, as required by regulation 13.7.3.3, but not necessarily all of them simultaneously, unless an independent temporary source of stored energy is provided. Power to the control, indication and alarm circuits as required by regulation 13.7.2 for half an hour.
 - 5.1** The emergency switchboard shall be installed as near as is practicable to the emergency source of electrical power.
 - 5.2** Where the emergency source of electrical power is a generator, the emergency switchboard shall be located in the same space unless the operation of the emergency switchboard would thereby be impaired.
 - 5.3** No accumulator battery fitted in accordance with this regulation shall be installed in the same space as the emergency switchboard. An indicator shall be mounted in a suitable place on the main switchboard or in the machinery control room to indicate when the batteries constituting either the emergency source of electrical power or the transitional source of emergency electrical power referred to in paragraph 3.1.3 or 4 are being discharged.
 - 5.4** The emergency switchboard shall be supplied during normal operation from the main switchboard by an interconnector feeder which is to be adequately protected at the main switchboard against overload and short circuit and which is to be disconnected automatically at the emergency switchboard upon failure of the main source of electrical power. Where the system is arranged for feedback operation, the interconnector feeder is also to be protected at the emergency switchboard at least against short circuit.
 - 5.5** In order to ensure ready availability of the emergency source of electrical power, arrangements shall be made where necessary to disconnect automatically non-emergency circuits from the emergency switchboard to ensure that power shall be available to the emergency circuits.

6 The emergency generator and its prime mover and any emergency accumulator battery shall be so designed and arranged as to ensure that they will function at full rated power when the ship is upright and when inclined at any angle of list up to 22.5° or when inclined up to 10° either in the fore or aft direction, or is in any combination of angles within those limits.

7 Provision shall be made for the periodic testing of the complete emergency system and shall include the testing of automatic starting arrangements.

Regulation 42-1

Supplementary emergency lighting for ro-ro passenger ships

(This regulation applies to all passenger ships with ro-ro cargo spaces or special category spaces as defined in regulation II-2/3, except that for ships constructed before 22 October 1989, this regulation shall apply not later than 22 October 1990)

1 In addition to the emergency lighting required by regulation 42.2, on every passenger ship with ro-ro cargo spaces or special category spaces as defined in regulation II-2/3:

- .1 all passenger public spaces and alleyways shall be provided with supplementary electric lighting that can operate for at least 3 h when all other sources of electrical power have failed and under any condition of heel. The illumination provided shall be such that the approach to the means of escape can be readily seen. The source of power for the supplementary lighting shall consist of accumulator batteries located within the lighting units that are continuously charged, where practicable, from the emergency switchboard. Alternatively, any other means of lighting which is at least as effective may be accepted by the Administration. The supplementary lighting shall be such that any failure of the lamp will be immediately apparent. Any accumulator battery provided shall be replaced at intervals having regard to the specified service life in the ambient conditions that they are subject to in service; and
- .2 a portable rechargeable battery operated lamp shall be provided in every crew space alleyway, recreational space and every working space which is normally occupied unless supplementary emergency lighting, as required by subparagraph .1, is provided.

Regulation 43

Emergency source of electrical power in cargo ships

SEE INTERPRETATION 44

1.1 A self-contained emergency source of electrical power shall be provided.

1.2 The emergency source of electrical power, associated transforming equipment, if any, transitional source of emergency power, emergency switchboard and emergency lighting switchboard shall be located above the uppermost continuous deck and shall be readily accessible from the open deck. They shall not be located forward of the collision bulkhead, except where permitted by the Administration in exceptional circumstances.

1.3 The location of the emergency source of electrical power, associated transforming equipment, if any, the transitional source of emergency power, the emergency switchboard and the emergency lighting switchboard in relation to the main source of electrical power, associated transforming equipment, if any, and the main switchboard shall be such as to ensure to the satisfaction of the Administration that a fire or other casualty in the space containing the main source of electrical power, associated transforming equipment, if any, and the main switchboard, or in any machinery space of category A will not interfere with the supply, control and distribution of emergency electrical power. As far as practicable the space containing the emergency source of electrical power, associated transforming equipment, if any, the transitional source of emergency electrical power and the emergency switchboard shall not be contiguous to the boundaries of machinery spaces of category A or those spaces containing the main source of electrical power, associated transforming equipment, if any, and the main switchboard.

1.4 Provided that suitable measures are taken for safeguarding independent emergency operation under all circumstances, the emergency generator may be used, exceptionally, and for short periods, to supply non-emergency circuits.

2 The electrical power available shall be sufficient to supply all those services that are essential for safety in an emergency, due regard being paid to such services as may have to be operated simultaneously. The emergency source of electrical power shall be capable, having regard to starting currents and the transitory nature of certain loads, of supplying simultaneously at least the following services for the periods specified hereinafter, if they depend upon an electrical source for their operation:

2.1 For a period of 3 h, emergency lighting at every muster and embarkation station and over the sides as required by regulations III/11.4 and III/16.7.

2.2 For a period of 18 h, emergency lighting:

- .1 in all service and accommodation alleyways, stairways and exits, personnel lift cars and personnel lift trunks;
- .2 in the machinery spaces and main generating stations including their control positions;
- .3 in all control stations, machinery control rooms, and at each main and emergency switchboard;
- .4 at all stowage positions for firemen's outfits;
- .5 at the steering gear;
- .6 at the fire pump referred to in paragraph 2.5, at the sprinkler pump, if any, and at the emergency bilge pump, if any, and at the starting positions of their motors; and
- .7 in all cargo pump-rooms of tankers constructed on or after 1 July 2002.

2.3 For a period of 18 h:

- .1 the navigation lights and other lights required by the International Regulations for Preventing Collisions at Sea in force;
- .2 on ships constructed on or after 1 February 1995 the VHF radio installation required by regulation IV/7.1.1 and IV/7.1.2; and, if applicable:
 - .1 the MF radio installation required by regulations IV/9.1.1, IV/9.1.2, IV/10.1.2 and IV/10.1.3;
 - .2 the ship earth station required by regulation IV/10.1.1; and
 - .3 the MF/HF radio installation required by regulations IV/10.2.1, IV/10.2.2 and IV/11.1.

2.4 For a period of 18 h:

- .1 all internal communication equipment as required in an emergency;
- .2 the shipborne navigational equipment as required by regulation V/19; where such provision is unreasonable or impracticable the Administration may waive this requirement for ships of less than 5,000 gross tonnage;
- .3 the fire detection and fire alarm system; and
- .4 intermittent operation of the daylight signalling lamp, the ship's whistle, the manually operated call points and all internal signals that are required in an emergency;

unless such services have an independent supply for the period of 18 h from an accumulator battery suitably located for use in an emergency.

2.5 For a period of 18 h one of the fire pumps required by regulations II-2/10.2.2.2 and II-2/10.2.2.3; if dependent upon the emergency generator for its source of power.

2.6.1 For the period of time required by regulation 29.14 the steering gear where it is required to be so supplied by that regulation.

2.6.2 In a ship engaged regularly in voyages of short duration, the Administration if satisfied that an adequate standard of safety would be attained may accept a lesser period than the 18 h period specified in paragraphs 2.2 to 2.5 but not less than 12 h.

3 The emergency source of electrical power may be either a generator or an accumulator battery, which shall comply with the following:

3.1 Where the emergency source of electrical power is a generator, it shall be:

- .1** driven by a suitable prime mover with an independent supply of fuel, having a flashpoint (closed-cup test) of not less than 43°C;
- .2** started automatically upon failure of the main source of electrical power supply unless a transitional source of emergency electrical power in accordance with paragraph 3.1.3 is provided; where the emergency generator is automatically started, it shall be automatically connected to the emergency switchboard; those services referred to in paragraph 4 shall then be connected automatically to the emergency generator; and unless a second independent means of starting the emergency generator is provided the single source of stored energy shall be protected to preclude its complete depletion by the automatic starting system; and
- .3** provided with a transitional source of emergency electrical power as specified in paragraph 4 unless an emergency generator is provided capable both of supplying the services mentioned in that paragraph and of being automatically started and supplying the required load as quickly as is safe and practicable subject to a maximum of 45 s.

3.2 Where the emergency source of electrical power is an accumulator battery it shall be capable of:

- .1** carrying the emergency electrical load without recharging while maintaining the voltage of the battery throughout the discharge period within 12% above or below its nominal voltage;
- .2** automatically connecting to the emergency switchboard in the event of failure of the main source of electrical power; and
- .3** immediately supplying at least those services specified in paragraph 4.

3.3 The following provision in paragraph 3.1.2 shall not apply to ships constructed on or after 1 October 1994:

Unless a second independent means of starting the emergency generating set is provided, the single source of stored energy shall be protected to preclude its complete depletion by the automatic starting system.

3.4 For ships constructed on or after 1 July 1998, where electrical power is necessary to restore propulsion, the capacity shall be sufficient to restore propulsion to the ship in conjunction with other machinery, as appropriate, from a dead ship condition within 30 min after blackout.

4 The transitional source of emergency electrical power where required by paragraph 3.1.3 shall consist of an accumulator battery suitably located for use in an emergency which shall operate without recharging while maintaining the voltage of the battery throughout the discharge period within 12% above or below its nominal voltage and be of sufficient capacity and shall be so arranged as to supply automatically in the event of failure of either the main or the emergency source of electrical power for half an hour at least the following services if they depend upon an electrical source for their operation:

- .1** the lighting required by paragraphs 2.1, 2.2 and 2.3.1. For this transitional phase, the required emergency electric lighting, in respect of the machinery space and accommodation and service spaces may be provided by permanently fixed, individual, automatically charged, relay operated accumulator lamps; and
- .2** all services required by paragraphs 2.4.1, 2.4.3 and 2.4.4 unless such services have an independent supply for the period specified from an accumulator battery suitably located for use in an emergency.

5.1 The emergency switchboard shall be installed as near as is practicable to the emergency source of electrical power.

5.2 Where the emergency source of electrical power is a generator, the emergency switchboard shall be located in the same space unless the operation of the emergency switchboard would thereby be impaired.

5.3 No accumulator battery fitted in accordance with this regulation shall be installed in the same space as the emergency switchboard. An indicator shall be mounted in a suitable place on the main switchboard or in the machinery control room to indicate when the batteries constituting either the emergency source of electrical power or the transitional source of electrical power referred to in paragraph 3.2 or 4 are being discharged.

5.4 The emergency switchboard shall be supplied during normal operation from the main switchboard by an interconnector feeder which is to be adequately protected at the main switchboard against overload and short circuit and which is to be disconnected automatically at the emergency switchboard upon failure of the main source of electrical power. Where the system is arranged for feedback operation, the interconnector feeder is also to be protected at the emergency switchboard at least against short circuit.

5.5 In order to ensure ready availability of the emergency source of electrical power, arrangements shall be made where necessary to disconnect automatically non-emergency circuits from the emergency switchboard to ensure that electrical power shall be available automatically to the emergency circuits.

6 The emergency generator and its prime mover and any emergency accumulator battery shall be so designed and arranged as to ensure that they will function at full rated power when the ship is upright and when inclined at any angle of list up to 22.5° or when inclined up to 10° either in the fore or aft direction, or is in any combination of angles within those limits.

7 Provision shall be made for the periodic testing of the complete emergency system and shall include the testing of automatic starting arrangements.

Regulation 44

Starting arrangements for emergency generating sets

1 Emergency generating sets shall be capable of being readily started in their cold condition at a temperature of 0°C. If this is impracticable, or if lower temperatures are likely to be encountered, provision acceptable to the Administration shall be made for the maintenance of heating arrangements, to ensure ready starting of the generating sets.

SEE INTERPRETATION 45

2 Each emergency generating set arranged to be automatically started shall be equipped with starting devices approved by the Administration with a stored energy capability of at least three consecutive starts. A second source of energy shall be provided for an additional three starts within 30 min unless manual starting can be demonstrated to be effective.

SEE INTERPRETATION 46

2.1 Ships constructed on or after 1 October 1994, in lieu of the provision of the second sentence of paragraph 2, shall comply with the following requirements:

The source of stored energy shall be protected to preclude critical depletion by the automatic starting system, unless a second independent means of starting is provided. In addition, a second source of energy shall be provided for an additional three starts within 30 min unless manual starting can be demonstrated to be effective.

3 The stored energy shall be maintained at all times, as follows:

- .1 electrical and hydraulic starting systems shall be maintained from the emergency switchboard;
- .2 compressed air starting systems may be maintained by the main or auxiliary compressed air receivers through a suitable non-return valve or by an emergency air compressor which, if electrically driven, is supplied from the emergency switchboard;

- II-1
- .3 all of these starting, charging and energy storing devices shall be located in the emergency generator space; these devices are not to be used for any purpose other than the operation of the emergency generating set. This does not preclude the supply to the air receiver of the emergency generating set from the main or auxiliary compressed air system through the non-return valve fitted in the emergency generator space.

4.1 Where automatic starting is not required, manual starting is permissible, such as manual cranking, inertia starters, manually charged hydraulic accumulators, or powder charge cartridges, where they can be demonstrated as being effective.

4.2 When manual starting is not practicable, the requirements of paragraphs 2 and 3 shall be complied with except that starting may be manually initiated.

Regulation 45

Precautions against shock, fire and other hazards of electrical origin

(Paragraphs 10 and 11 of this regulation apply to ships constructed on or after 1 January 2007)

1.1 Exposed metal parts of electrical machines or equipment which are not intended to be live but which are liable under fault conditions to become live shall be earthed unless the machines or equipment are:

- .1 supplied at a voltage not exceeding 50 V direct current or 50 V root mean square between conductors; auto-transformers shall not be used for the purpose of achieving this voltage; or
- .2 supplied at a voltage not exceeding 250 V by safety isolating transformers supplying only one consuming device; or
- .3 constructed in accordance with the principle of double insulation.

1.2 The Administration may require additional precautions for portable electrical equipment for use in confined or exceptionally damp spaces where particular risks due to conductivity may exist.

1.3 All electrical apparatus shall be so constructed and so installed as not to cause injury when handled or touched in the normal manner.

2 Main and emergency switchboards shall be so arranged as to give easy access as may be needed to apparatus and equipment, without danger to personnel. The sides and the rear and, where necessary, the front of switchboards shall be suitably guarded. Exposed live parts having voltages to earth exceeding a voltage to be specified by the Administration shall not be installed on the front of such switchboards. Where necessary, non-conducting mats or gratings shall be provided at the front and rear of the switchboard.

3.1 The hull return system of distribution shall not be used for any purpose in a tanker, or for power, heating, or lighting in any other ship of 1,600 gross tonnage and upwards.

3.2 The requirement of paragraph 3.1 does not preclude under conditions approved by the Administration the use of:

- .1 impressed current cathodic protective systems;
- .2 limited and locally earthed systems; or
- .3 insulation level monitoring devices provided the circulation current does not exceed 30 mA under the most unfavourable conditions.

3.2-1 For ships constructed on or after 1 October 1994, the requirement of paragraph 3.1 does not preclude the use of limited and locally earthed systems, provided that any possible resulting current does not flow directly through any dangerous spaces.

3.3 Where the hull return system is used, all final subcircuits, i.e. all circuits fitted after the last protective device, shall be two-wire and special precautions shall be taken to the satisfaction of the Administration.

4.1 Earthed distribution systems shall not be used in a tanker. The Administration may exceptionally permit in a tanker the earthing of the neutral for alternating current power networks of 3,000 V (line to line) and over, provided that any possible resulting current does not flow directly through any of the dangerous spaces.

4.2 When a distribution system, whether primary or secondary, for power, heating or lighting, with no connection to earth is used, a device capable of continuously monitoring the insulation level to earth and of giving an audible or visual indication of abnormally low insulation values shall be provided.

4.3 Ships constructed on or after 1 October 1994, in lieu of the provisions of paragraph 4.1, shall comply with the following requirements:

- .1 Except as permitted by paragraph 4.3.2, earthed distribution systems shall not be used in a tanker.
- .2 The requirement of paragraph 4.3.1 does not preclude the use of earthed intrinsically safe circuits and in addition, under conditions approved by the Administration, the use of the following earthed systems:
 - .1 power-supplied control circuits and instrumentation circuits where technical or safety reasons preclude the use of a system with no connection to earth, provided the current in the hull is limited to not more than 5 A in both normal and fault conditions; or
 - .2 limited and locally earthed systems, provided that any possible resulting current does not flow directly through any of the dangerous spaces; or
 - .3 alternating current power networks of 1,000 V root mean square (line to line) and over, provided that any possible resulting current does not flow directly through any of the dangerous spaces.

5.1 Except as permitted by the Administration in exceptional circumstances, all metal sheaths and armour of cables shall be electrically continuous and shall be earthed.

5.2 All electric cables and wiring external to equipment shall be at least of a flame-retardant type and shall be so installed as not to impair their original flame-retarding properties. Where necessary for particular applications the Administration may permit the use of special types of cables such as radio frequency cables, which do not comply with the foregoing.

5.3 Cables and wiring serving essential or emergency power, lighting, internal communications or signals shall so far as practicable be routed clear of galleys, laundries, machinery spaces of category A and their casings and other high fire risk areas. In ro-ro passenger ships, cabling for emergency alarms and public address systems installed on or after 1 July 1998 shall be approved by the Administration having regard to the recommendations developed by the Organization.* Cables connecting fire pumps to the emergency switchboard shall be of a fire-resistant type where they pass through high fire risk areas. Where practicable all such cables should be run in such a manner as to preclude their being rendered unserviceable by heating of the bulkheads that may be caused by a fire in an adjacent space.

5.4 Where cables which are installed in hazardous areas introduce the risk of fire or explosion in the event of an electrical fault in such areas, special precautions against such risks shall be taken to the satisfaction of the Administration.

5.5 Cables and wiring shall be installed and supported in such a manner as to avoid chafing or other damage.

5.6 Terminations and joints in all conductors shall be so made as to retain the original electrical, mechanical, flame-retarding and, where necessary, fire-resisting properties of the cable.

6.1 Each separate circuit shall be protected against short circuit and against overload, except as permitted in regulations 29 and 30 or where the Administration may exceptionally otherwise permit.

6.2 The rating or appropriate setting of the overload protective device for each circuit shall be permanently indicated at the location of the protective device.

* Refer to *Recommendation on performance standards for public address systems on passenger ships, including cabling* (MSC/Circ.808).

7 Lighting fittings shall be so arranged as to prevent temperature rises which could damage the cables and wiring, and to prevent surrounding material from becoming excessively hot.

8 All lighting and power circuits terminating in a bunker or cargo space shall be provided with a multiple-pole switch outside the space for disconnecting such circuits.

9.1 Accumulator batteries shall be suitably housed, and compartments used primarily for their accommodation shall be properly constructed and efficiently ventilated.

9.2 Electrical or other equipment which may constitute a source of ignition of flammable vapours shall not be permitted in these compartments except as permitted in paragraph 10.

9.3 Accumulator batteries shall not be located in sleeping quarters except where hermetically sealed to the satisfaction of the Administration.

10 No electrical equipment shall be installed in any space where flammable mixtures are liable to collect, e.g. in compartments assigned principally to accumulator batteries, in paint lockers, acetylene stores or similar spaces, unless the Administration is satisfied that such equipment is:

- .1 essential for operational purposes;
- .2 of a type which will not ignite the mixture concerned;
- .3 appropriate to the space concerned; and
- .4 appropriately certified for safe usage in the dusts, vapours or gases likely to be encountered.

11 In tankers, electrical equipment, cables and wiring shall not be installed in hazardous locations unless it conforms with standards not inferior to those acceptable to the Organization.* However, for locations not covered by such standards, electrical equipment, cables and wiring which do not conform to the standards may be installed in hazardous locations based on a risk assessment to the satisfaction of the Administration, to ensure that an equivalent level of safety is assured.

SEE INTERPRETATION 47

12 In a passenger ship, distribution systems shall be so arranged that fire in any main vertical zone as is defined in regulation II-2/3.32 will not interfere with services essential for safety in any other such zone. This requirement will be met if main and emergency feeders passing through any such zone are separated both vertically and horizontally as widely as is practicable.

* Refer to the standards published by the International Electrotechnical Commission, and in particular IEC 60092-502:1999, *Electrical installations in ships – Tankers*.

Part E

Additional requirements for periodically unattended machinery spaces

(Part E applies to cargo ships except that regulation 54 refers to passenger ships)

Regulation 46

General

- 1 The arrangements provided shall be such as to ensure that the safety of the ship in all sailing conditions, including manoeuvring, is equivalent to that of a ship having the machinery spaces manned.
- 2 Measures shall be taken to the satisfaction of the Administration to ensure that the equipment is functioning in a reliable manner and that satisfactory arrangements are made for regular inspections and routine tests to ensure continuous reliable operation.
- 3 Every ship shall be provided with documentary evidence, to the satisfaction of the Administration, of its fitness to operate with periodically unattended machinery spaces.

Regulation 47

Fire precautions

- 1 Means shall be provided to detect and give alarms at an early stage in case of fires:
 - .1 in boiler air supply casings and exhausts (uptakes); and
 - .2 in scavenging air belts of propulsion machinery,

unless the Administration considers this to be unnecessary in a particular case.

- 2 Internal combustion engines of 2,250 kW and above or having cylinders of more than 300 mm bore shall be provided with crankcase oil mist detectors or engine bearing temperature monitors or equivalent devices.

Regulation 48

Protection against flooding

- 1 Bilge wells in periodically unattended machinery spaces shall be located and monitored in such a way that the accumulation of liquids is detected at normal angles of trim and heel, and shall be large enough to accommodate easily the normal drainage during the unattended period.
- 2 Where the bilge pumps are capable of being started automatically, means shall be provided to indicate when the influx of liquid is greater than the pump capacity or when the pump is operating more frequently than would normally be expected. In these cases, smaller bilge wells to cover a reasonable period of time may be permitted. Where automatically controlled bilge pumps are provided, special attention shall be given to oil pollution prevention requirements.

3 The location of the controls of any valve serving a sea inlet, a discharge below the waterline or a bilge injection system shall be so sited as to allow adequate time for operation in case of influx of water to the space, having regard to the time likely to be required in order to reach and operate such controls. If the level to which the space could become flooded with the ship in the fully loaded condition so requires, arrangements shall be made to operate the controls from a position above such level.

SEE INTERPRETATION 48

Regulation 49

Control of propulsion machinery from the navigation bridge

1 Under all sailing conditions, including manoeuvring, the speed, direction of thrust and, if applicable, the pitch of the propeller shall be fully controllable from the navigation bridge.

1.1 Such remote control shall be performed by a single control device for each independent propeller, with automatic performance of all associated services, including, where necessary, means of preventing overload of the propulsion machinery.

1.2 The main propulsion machinery shall be provided with an emergency stopping device on the navigation bridge which shall be independent of the navigation bridge control system.

2 Propulsion machinery orders from the navigation bridge shall be indicated in the main machinery control room or at the propulsion machinery control position as appropriate.

3 Remote control of the propulsion machinery shall be possible only from one location at a time; at such locations interconnected control positions are permitted. At each location there shall be an indicator showing which location is in control of the propulsion machinery. The transfer of control between the navigation bridge and machinery spaces shall be possible only in the main machinery space or in the main machinery control room. The system shall include means to prevent the propelling thrust from altering significantly when transferring control from one location to another.

4 It shall be possible for all machinery essential for the safe operation of the ship to be controlled from a local position, even in the case of failure in any part of the automatic or remote control systems.

5 The design of the remote automatic control system shall be such that in case of its failure an alarm will be given. Unless the Administration considers it impracticable, the preset speed and direction of thrust of the propeller shall be maintained until local control is in operation.

6 Indicators shall be fitted on the navigation bridge for:

- .1 propeller speed and direction of rotation in the case of fixed pitch propellers; or
- .2 propeller speed and pitch position in the case of controllable pitch propellers.

7 The number of consecutive automatic attempts which fail to produce a start shall be limited to safeguard sufficient starting air pressure. An alarm shall be provided to indicate low starting air pressure set at a level which still permits starting operations of the propulsion machinery.

Regulation 50

Communication

A reliable means of vocal communication shall be provided between the main machinery control room or the propulsion machinery control position as appropriate, the navigation bridge and the engineer officers' accommodation.

Regulation 51*Alarm system*

- 1 An alarm system shall be provided indicating any fault requiring attention and shall:
 - .1 be capable of sounding an audible alarm in the main machinery control room or at the propulsion machinery control position, and indicate visually each separate alarm function at a suitable position;
 - .2 have a connection to the engineers' public rooms and to each of the engineers' cabins through a selector switch, to ensure connection to at least one of those cabins. Administrations may permit equivalent arrangements;
 - .3 activate an audible and visual alarm on the navigation bridge for any situation which requires action by or attention of the officer on watch;
 - .4 as far as is practicable be designed on the fail-to-safety principle; and
 - .5 activate the engineers' alarm required by regulation 38 if an alarm function has not received attention locally within a limited time.
- 2.1 The alarm system shall be continuously powered and shall have an automatic change-over to a stand-by power supply in case of loss of normal power supply.
- 2.2 Failure of the normal power supply of the alarm system shall be indicated by an alarm.
- 3.1 The alarm system shall be able to indicate at the same time more than one fault and the acceptance of any alarm shall not inhibit another alarm.
- 3.2 Acceptance at the position referred to in paragraph 1 of any alarm condition shall be indicated at the positions where it was shown. Alarms shall be maintained until they are accepted and the visual indications of individual alarms shall remain until the fault has been corrected, when the alarm system shall automatically reset to the normal operating condition.

Regulation 52*Safety systems*

A safety system shall be provided to ensure that serious malfunction in machinery or boiler operations, which presents an immediate danger, shall initiate the automatic shutdown of that part of the plant and that an alarm shall be given. Shutdown of the propulsion system shall not be automatically activated except in cases which could lead to serious damage, complete breakdown, or explosion. Where arrangements for overriding the shutdown of the main propelling machinery are fitted, these shall be such as to preclude inadvertent operation. Visual means shall be provided to indicate when the override has been activated.

Regulation 53*Special requirements for machinery, boiler and electrical installations*

- 1 The special requirements for the machinery, boiler and electrical installations shall be to the satisfaction of the Administration and shall include at least the requirements of this regulation.
- 2 The main source of electrical power shall comply with the following:
 - 2.1 Where the electrical power can normally be supplied by one generator, suitable load-shedding arrangements shall be provided to ensure the integrity of supplies to services required for propulsion and steering as well as the safety of the ship. In the case of loss of the generator in operation, adequate provision shall be made for automatic starting and connecting to the main switchboard of a stand-by generator of sufficient capacity to permit propulsion and steering and to ensure the safety of the ship with automatic

restarting of the essential auxiliaries including, where necessary, sequential operations. The Administration may dispense with this requirement for a ship of less than 1,600 gross tonnage, if it is considered impracticable.

2.2 If the electrical power is normally supplied by more than one generator simultaneously in parallel operation, provision shall be made, for instance by load shedding, to ensure that, in case of loss of one of these generating sets, the remaining ones are kept in operation without overload to permit propulsion and steering, and to ensure the safety of the ship.

3 Where stand-by machines are required for other auxiliary machinery essential to propulsion, automatic change-over devices shall be provided.

4 Automatic control and alarm system

4.1 The control system shall be such that the services needed for the operation of the main propulsion machinery and its auxiliaries are ensured through the necessary automatic arrangements.

4.2 An alarm shall be given on the automatic change-over.

4.3 An alarm system complying with regulation 51 shall be provided for all important pressures, temperatures and fluid levels and other essential parameters.

4.4 A centralized control position shall be arranged with the necessary alarm panels and instrumentation indicating any alarm.

5 Means shall be provided to keep the starting air pressure at the required level where internal combustion engines are used for main propulsion.

Regulation 54

Special consideration in respect of passenger ships

Passenger ships shall be specially considered by the Administration as to whether or not their machinery spaces may be periodically unattended and if so whether additional requirements to those stipulated in these regulations are necessary to achieve equivalent safety to that of normally attended machinery spaces.

Part F

Alternative design and arrangements

Regulation 55

Alternative design and arrangements

1 Purpose

The purpose of this regulation is to provide a methodology for alternative design and arrangements for machinery, electrical installations and low-flashpoint fuel storage and distribution systems.

2 General

2.1 Machinery, electrical installation and low-flashpoint fuel storage and distribution systems design and arrangements may deviate from the requirements set out in parts C, D, E or G, provided that the alternative design and arrangements meet the intent of the requirements concerned and provide an equivalent level of safety to this chapter.

2.2 When alternative design or arrangements deviate from the prescriptive requirements of parts C, D, E or G, an engineering analysis, evaluation and approval of the design and arrangements shall be carried out in accordance with this regulation.

3 Engineering analysis

The engineering analysis shall be prepared and submitted to the Administration, based on the guidelines developed by the Organization* and shall include, as a minimum, the following elements:

- .1 determination of the ship type, machinery, electrical installations, low-flashpoint fuel storage and distribution systems and space(s) concerned;
- .2 identification of the prescriptive requirement(s) with which the machinery, electrical installations and low-flashpoint fuel storage and distribution systems will not comply;
- .3 identification of the reason the proposed design will not meet the prescriptive requirements supported by compliance with other recognized engineering or industry standards;
- .4 determination of the performance criteria for the ship, machinery, electrical installation, low-flashpoint fuel storage and distribution system or the space(s) concerned addressed by the relevant prescriptive requirement(s):
 - .1 performance criteria shall provide a level of safety not inferior to the relevant prescriptive requirements contained in parts C, D, E or G; and
 - .2 performance criteria shall be quantifiable and measurable;
- .5 detailed description of the alternative design and arrangements, including a list of the assumptions used in the design and any proposed operational restrictions or conditions;
- .6 technical justification demonstrating that the alternative design and arrangements meet the safety performance criteria; and

* Refer to the *Guidelines on alternative design and arrangements for SOLAS chapters II-1 and III (MSC.1/Circ.1212)* and the *Guidelines for the approval of alternatives and equivalents as provided for in various IMO instruments (MSC.1/Circ.1455)*.

- .7 risk assessment based on identification of the potential faults and hazards associated with the proposal.

4 Evaluation of the alternative design and arrangements

4.1 The engineering analysis required in paragraph 3 shall be evaluated and approved by the Administration, taking into account the guidelines developed by the Organization.*

4.2 A copy of the documentation, as approved by the Administration, indicating that the alternative design and arrangements comply with this regulation shall be carried on board the ship.

5 Exchange of information

The Administration shall communicate to the Organization pertinent information concerning alternative design and arrangements approved by them for circulation to all Contracting Governments.

6 Re-evaluation due to change of conditions

If the assumptions and operational restrictions that were stipulated in the alternative design and arrangements are changed, the engineering analysis shall be carried out under the changed condition and shall be approved by the Administration.

* Refer to *Revised guidelines on alternative design and arrangements for SOLAS chapters II-1 and III* (MSC.1/Circ.1212/Rev.1).

Part G

Ships using low-flashpoint fuels

Regulation 56

Application

- 1 Except as provided for in paragraphs 4 and 5, this part shall apply to ships using low-flashpoint fuels:
 - .1 for which the building contract is placed on or after 1 January 2017;
 - .2 in the absence of a building contract, the keels of which are laid or which are at a similar stage of construction on or after 1 July 2017; or
 - .3 the delivery of which is on or after 1 January 2021.

Such ships using low-flashpoint fuels shall comply with the requirements of this part in addition to any other applicable requirements of the present regulations.

2 Except as provided for in paragraphs 4 and 5, a ship, irrespective of the date of construction, including one constructed before 1 January 2009, which converts to using low-flashpoint fuels on or after 1 January 2017 shall be treated as a ship using low-flashpoint fuels on the date on which such conversion commenced.

3 Except as provided for in paragraphs 4 and 5, a ship using low-flashpoint fuels, irrespective of the date of construction, including one constructed before 1 January 2009, which, on or after 1 January 2017, undertakes to use low-flashpoint fuels different from those which it was originally approved to use before 1 January 2017 shall be treated as a ship using low-flashpoint fuels on the date on which such undertaking commenced.

- 4 This part shall not apply to gas carriers, as defined in regulation VII/11.2:
 - .1 using their cargoes as fuel and complying with the requirements of the IGC Code, as defined in regulation VII/11.1; or
 - .2 using other low-flashpoint gaseous fuels provided that the fuel storage and distribution systems design and arrangements for such gaseous fuels comply with the requirements of the IGC Code for gas as a cargo.

5 This part shall not apply to ships owned or operated by a Contracting Government and used, for the time being, only in government non-commercial service. However, ships owned or operated by a Contracting Government and used, for the time being, only in Government non-commercial service are encouraged to act in a manner consistent, so far as reasonable and practicable, with this part.

Regulation 57

Requirements for ships using low-flashpoint fuels

Except as provided in regulations 56.4 and 56.5, ships using low-flashpoint fuels shall comply with the requirements of the IGF Code.

Unified Interpretations for Chapter II-1

1 Application

(Source: MSC-MEPC.2/Circ.10)

- Reg. 1.3 For conversions of single-hull oil tankers to double-hull oil tankers or bulk carriers, the following should apply:
- .1 Conversions of single-hull oil tankers to double-hull oil tankers or bulk carriers should be regarded as modifications of a major character for the purposes of SOLAS chapter II-1.
 - .2 Repairs, alterations and modifications of a major character include:
 - .1 Substantial alteration of the dimensions of a ship, for example lengthening of a ship by adding a new midbody. The new midbody should comply with SOLAS chapter II-1.
 - .2 A change of ship type, for example an oil tanker converted to a bulk carrier. Any structure, machinery and systems that are added or modified should comply with SOLAS chapter II-1, taking into account the interpretation of SOLAS chapter II-1 regulations as contained herein.

2 Deadweight to be stated on certificates

(Source: MSC.1/Circ.1573)

- Reg. 2.20 Even-keel hydrostatics should be used to determine the regulatory deadweight to be entered on relevant statutory certificates.

3 Definition of the term "Lightweight"

(Source: MSC.1/Circ.1539/Rev.1)

- Reg. 2.21 The weight of mediums on board for the fixed fire-fighting systems (e.g. freshwater, CO₂, dry chemical powder, foam concentrate, etc.) should be included in the lightweight and lightweight condition.

4 Protective coatings of dedicated seawater ballast tanks in all types of ships and double-side skin spaces of bulk carriers

(Source: MSC.1/Circ.1539/Rev.1)

- Reg. 3-2 The following tanks should not be considered to be dedicated seawater ballast tanks and should, therefore, be exempted from the application and requirements of the *Performance standard for protective coatings for dedicated seawater ballast tanks in all types of ships and double-side skin spaces of bulk carriers* (resolution MSC.215(82)), provided the coatings applied in the tanks described in sub-paragraphs .2 and .3 below are confirmed by the coating manufacturer to be resistant to the media stored in these tanks and provided such coatings are applied and maintained according to the coating manufacturer's procedures.

- .1 ballast tanks identified as "Spaces included in Net Tonnage" in the International Tonnage Certificate (1969);
- .2 seawater ballast tanks in passenger ships also designated for the carriage of grey water or black water; and
- .3 seawater ballast tanks in livestock carriers also designated for the carriage of livestock dung.

5 Protective coatings of dedicated seawater ballast tanks in all types of ships and double-side skin spaces of bulk carriers

(Source: MSC-MEPC.2/Circ.10)

- Regs. 3-2.2 and 3-2.4
- 5.1 For single-hull oil tanker conversion into double-hull oil tanker, SOLAS regulation II-1/3-2 as adopted by resolution MSC.216(82) should apply to dedicated water ballast tanks if constructed with all structural members being entirely new. If converting existing spaces into water ballast tanks with part of the existing structural members remaining in place, revised SOLAS regulation II-1/3-2 (MSC.216(82)) need not be applied. However, dedicated seawater ballast tanks should have an efficient corrosion prevention system such as hard protective coatings or equivalent and be of light colour.
- 5.2 For single-hull oil tanker conversion into bulk carrier, SOLAS regulation II-1/3-2 as adopted by resolution MSC.216(82) should apply to dedicated water ballast tanks and double-side skin spaces of bulk carriers if constructed with all structural members being entirely new. If converting existing spaces into dedicated water ballast tanks or double-side skin space of bulk carriers with part of the existing structural members remaining in place, revised SOLAS regulation II-1/3-2 (MSC.216(82)) need not be applied. However, dedicated seawater ballast tanks should have an efficient corrosion prevention system such as hard protective coatings or equivalent and be of light colour.

6 New installation of materials containing asbestos (Source: MSC.1/Circ.1426/Rev.1)

Reg. 3-5 Administrations or recognized organizations acting on their behalf should verify that materials which contain asbestos, as prohibited under SOLAS regulation II-1/3-5, are not installed on ships by reviewing asbestos-free declarations and supporting documentation for the structure, machinery, electrical installations and equipment covered by the SOLAS Convention, which should be provided to the Administration or recognized organization by shipyards, repair yards and equipment manufacturers, taking into account appendix 6 of the 2015 *Guidelines for the development of the inventory of hazardous materials* (resolution MEPC.269(68)).

7 Access to and within spaces in, and forward of, the cargo area of oil tankers and bulk carriers (Source: MSC-MEPC.2/Circ.10)Reg. 3-6 **7.1 For single-hull oil tanker conversion into double-hull oil tanker**

7.1.1 Permanent means of access contained in table 1 of the *Technical provisions for means of access for inspections* (resolution MSC.158(78)) need not apply. However, if, in the course of conversion, substantial new structures are added, these new structures should comply with the regulation.

7.1.2 The term "substantial new structures" means hull structures that are entirely renewed or augmented by new double bottom and/or double-side construction (e.g. replacing the entire structure within cargo area or adding a new double bottom and/or double-side section to the existing cargo area).

7.1.3 Additionally, an approved Ship Structure Access Manual should be provided.

7.2 For single-hull oil tanker conversion into bulk carrier

7.2.1 Permanent means of access contained in table 2 of the *Technical provisions for means of access for inspections* (resolution MSC.158(78)) need not apply. However, if, in the course of conversion, substantial new structures are added, these new structures should comply with the regulation.

7.2.2 The term "substantial new structures" means hull structures that are entirely renewed or augmented by new double bottom and/or double-side skin construction (e.g. replacing the entire structure within cargo area or adding a new double bottom and/or double-side section to the existing cargo area).

7.2.3 Additionally, an approved Ship Structure Access Manual should be provided.

8 Application (Source: MSC.1/Circ.1572)Reg. 3-6.1 **Oil tankers**

8.1 This regulation is only applicable to oil tankers having integral tanks for carriage of oil in bulk, which is contained in the definition of oil in Annex 1 of MARPOL. Independent oil tanks can be excluded. Regulation II-1/3-6 should not normally be applied to FPSO or FSU unless the Administration decides otherwise.

Technical background

8.2 Means of access specified in the Technical provisions contained in resolution MSC.158(78) are not specific with respect to the application to integral cargo oil tanks or also to independent cargo oil tanks. Enhanced survey programme (ESP) requirements of oil tankers have been established assuming the target cargo oil tanks are integral tanks. The means of access regulated under regulation II-1/3-6 is for overall and close-up inspections as defined in regulation IX/1. Therefore it is assumed that the target cargo oil tanks are those of ESP, i.e. integral cargo tanks. Regulation II-1/3-6 is applicable to new, purpose-built FPSO or FSU if they are subject to the scope of the 2011 ESP Code (resolution A.1049(27), as amended). Considering that the principles of the *Technical provisions for means of access for inspections* (resolution MSC.158(78)) recognize that permanent means of access should be considered and provided for at the design stage so that, to the maximum extent possible, they can be made an integral part of the designed structural arrangement, regulation II 1/3-6 is not considered applicable to an FPSO/FSU that is converted from an existing tanker.

Reference

8.3 SOLAS regulation IX/1 and the 2011 ESP Code, as amended.

9 Means of access to cargo and other spaces (Source: MSC.1/Circ.1572)

Reg. 3-6.2.1 Each space for which close-up inspection is not required such as fuel oil tanks and void spaces forward of cargo area, may be provided with a means of access necessary for overall survey intended to report on the overall conditions of the hull structure.

10 Means of access to cargo and other spaces

(Source: MSC.1/Circ.1572)

- Reg. 3-6.2.2 10.1 Some possible alternative means of access are listed under paragraph 3.9 of the *Technical provisions for means of access for inspections*. Always subject to acceptance as equivalent by the Administration, alternative means such as an unmanned robot arm, ROVs and dirigibles with necessary equipment of the permanent means of access for overall and close-up inspections and thickness measurements of the deck head structure such as deck transverses and deck longitudinals of cargo oil tanks and ballast tanks, should be capable of:
- .1 safe operation in ullage space in gas-free environment; and
 - .2 introduction into the place directly from a deck access.

Technical background

10.2 Innovative approaches, in particular the development of robots in place of elevated passageways, are encouraged and it is considered worthwhile to provide the functional requirement for the innovative approach.

11 Means of access to cargo and other spaces

(Source: MSC.1/Circ.1572)

Reg. 3-6.2.3 *Inspection*

11.1 The means of access arrangements, including portable equipment and attachments, should be periodically inspected by the crew or competent inspectors as and when it is going to be used to confirm that the means of access remains in serviceable condition.

Procedures

11.2 Any Company authorized person using the means of access should assume the role of inspector and check for obvious damage prior to using the access arrangements. Whilst using the means of access, the inspector should verify the condition of the sections used by close-up examination of those sections and note any deterioration in the provisions. Should any damage or deterioration be found, the effect of such deterioration should be assessed as to whether the damage or deterioration affects the safety for continued use of the access. Deterioration found that is considered to affect safe use should be determined as "substantial damage" and measures should be put in place to ensure that the affected section(s) are not to be further used prior to effective repair.

11.3 Statutory survey of any space that contains means of access should include verification of the continued effectiveness of the means of access in that space. Survey of the means of access should not be expected to exceed the scope and extent of the survey being undertaken. If the means of access is found deficient the scope of survey should be extended if this is considered appropriate.

11.4 Records of all inspections should be established based on the requirements detailed in the ship's Safety Management System. The records should be readily available to persons using the means of access and a copy attached to the Ship Structure Access Manual. The latest record for the portion of the means of access inspected should include as a minimum the date of the inspection, the name and title of the inspector, a confirmation signature, the sections of means of access inspected, verification of continued serviceable condition or details of any deterioration or substantial damage found. A file of permits issued should be maintained for verification.

Technical background

11.5 It is recognized that means of access may be subject to deterioration in the long term due to corrosive environment and external forces from ship motions and sloshing of liquid contained in the tank. Means of access therefore should be inspected at every opportunity of tank/space entry. The above interpretation should be contained in a section of the Ship Structure Access Manual.

12 Safe access to cargo holds, cargo tanks, ballast tanks and other spaces

(Source: MSC.1/Circ.1572)

- Reg. 3-6.3.1 12.1 Access to a double-side skin space of bulk carriers may be either from a topside tank or double-bottom tank or from both.
- 12.2 The wording "not intended for the carriage of oil or hazardous cargoes" applies only to "similar compartments", i.e. safe access can be through a pump-room, deep cofferdam, pipe tunnel, cargo hold or double-hull space.

Technical background

12.3 Unless used for other purposes, the double-side skin space should be designed as a part of a large U-shaped ballast tank and such space should be accessed through the adjacent part of the tank,

i.e. topside tank or double-bottom/bilge hopper tank. Access to the double-side skin space from the adjacent part rather than direct from the open deck is justified. Any such arrangement should provide a directly routed, logical and safe access that facilitates easy evacuation of the space.

13 Safe access to cargo holds, cargo tanks, ballast tanks and other spaces

(Source: MSC.1/Circ.1572)

Reg. 3-6.3.2 131 A cargo oil tank of less than 35 m length without a swash bulkhead requires only one access hatch.

13.2 Where rafting is indicated in the ship structures access manual as the means to gain ready access to the under-deck structure, the term "similar obstructions" referred to in the regulation includes internal structures (e.g. webs > 1.5 m deep) which restrict the ability to raft (at the maximum water level needed for rafting of under-deck structure) directly to the nearest access ladder and hatchway to deck. When rafts or boats alone, as an alternative means of access, are allowed under the conditions specified in the 2011 ESP Code, permanent means of access are to be provided to allow safe entry and exit. This means:

- .1 access direct from the deck via a vertical ladder and small platform fitted approximately 2 m below the deck in each bay; or
- .2 access to the deck from a longitudinal permanent platform having ladders to the deck in each end of the tank. The platform should, for the full length of the tank, be arranged in level with, or above, the maximum water level needed for rafting of the under-deck structure. For this purpose, the ullage corresponding to the maximum water level should not be assumed more than 3 m from the deck plate measured at the midspan of deck transverses and in the middle length of the tank (see figure below). A permanent means of access from the longitudinal permanent platform to the water level indicated above should be fitted in each bay (e.g. permanent rungs on one of the deck webs inboard of the longitudinal permanent platform).

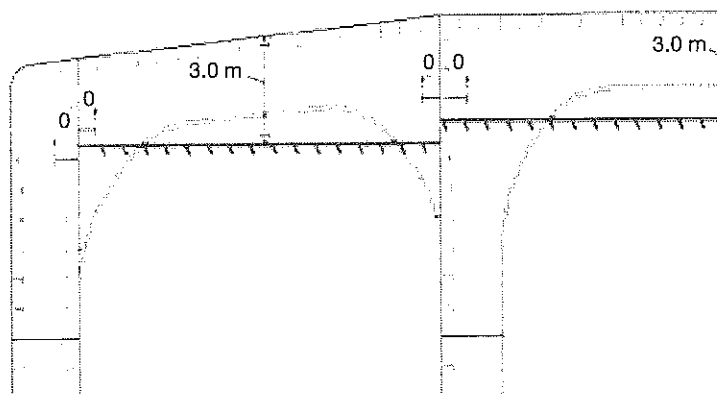

Figure 1

14 Ship Structure Access Manual

(Source: MSC.1/Circ.1572)

Reg. 3-6.4.1 14.1 The access manual should address spaces listed in paragraph 3 of regulation II-1/3-6. As a minimum the English version should be provided. The ship structure access manual should contain at least the following two parts:

Part 1: Plans, instructions and inventory required by paragraphs 4.1.1 to 4.1.7 of regulation II-1/3-6. This part should be approved by the Administration or the organization recognized by the Administration.

Part 2: Form of record of inspections and maintenance, and change of inventory of portable equipment due to additions or replacement after construction. This part should be approved for its form only at new building.

14.2 The following matters should be addressed in the ship structure access manual:

- .1 the access manual should clearly cover scope as specified in the regulations for use by crews, surveyors and port State control officers;
- .2 approval/re-approval procedure for the manual, i.e. any changes of the permanent, portable, movable or alternative means of access within the scope of the regulation and the Technical provisions are subject to review and approval by the Administration or by the organization recognized by the Administration;

- .3 verification of means of access should be part of the safety construction survey for continued effectiveness of the means of access in that space which is subject to the statutory survey;
- .4 inspection of means of access by the crew and/or a competent inspector of the company as a part of regular inspection and maintenance (see interpretation of paragraph 2.3 of regulation II-1/3-6);
- .5 actions to be taken if means of access is found unsafe to use; and
- .6 in case of use of portable equipment plans showing the means of access within each space indicating from where and how each area in the space can be inspected.

15 Ship Structure Access Manual

(Source: MSC.1/Circ.1572)

Reg. 3-6.4.2 15.1 Critical structural areas should be identified by advanced calculation techniques for structural strength and fatigue performance, if available, and feedback from the service history and design development of similar or sister ships.

15.2 Reference should be made to the following publications for critical structural areas, where applicable:

- .1 Oil tankers: *Guidance Manual for Tanker Structures* by TSCF;
- .2 Bulk carriers: *Bulk Carriers – Guidelines for Surveys, Assessment and Repair of Hull Structures* by IACS; and
- .3 Oil tankers and bulk carriers: the 2011 ESP Code (resolution A.1049(27), as amended).

Technical background

15.3 These documents contain the relevant information for the present ship types. However, identification of critical areas for new double-hull tankers and double-side skin bulk carriers of improved structural design should be made by structural analysis at the design stage, this information should be taken into account to ensure appropriate access to all identified critical areas.

16 General technical specifications

(Source: MSC.1/Circ.1572)

Reg. 3-6.5.1 16.1 The minimum clear opening of 600 mm × 600 mm may have corner radii up to 100 mm maximum. The clear opening is specified in MSC/Circ.686/Rev.1 to keep the opening fit for passage of personnel wearing a breathing apparatus. In such a case where as a consequence of structural analysis of a given design the stress should be reduced around the opening, it is considered appropriate to take measures to reduce the stress such as making the opening larger with increased radii, e.g. 600 × 800 with 300 mm radii, in which a clear opening of 600 × 600 mm with corner radii up to 100 mm maximum fits.

Technical background

16.2 The interpretation is based upon the established Guidelines in MSC.1/Circ.1572.

Reference

16.3 Paragraph 9 of the annex to MSC.1/Circ.1572

17 General technical specifications

(Source: MSC.1/Circ.1572)

Reg. 3-6.5.2 17.1 The minimum clear opening of not less than 600 mm × 800 mm may also include an opening with corner radii of 300 mm. An opening of 600 mm in height × 800 mm in width may be accepted as access openings in vertical structures where it is not desirable to make large openings in the structural strength aspects, i.e. girders and floors in double-bottom tanks.

17.2 Subject to verification of easy evacuation of an injured person on a stretcher the vertical opening 850 mm × 620 mm with wider upper half than 600 mm, while the lower half may be less than 600 mm with the overall height not less than 850 mm is considered an acceptable alternative to the traditional opening of 600 mm × 800 mm with corner radii of 300 mm.

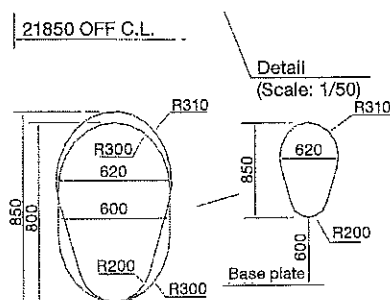

Figure 2

17.3 If a vertical opening is at a height of more than 600 mm steps then handgrips should be provided. In such arrangements it should be demonstrated that an injured person can be easily evacuated.

Technical background

17.4 The interpretation is based upon the established Guidelines in MSC/Circ.686/Rev.1 and an innovative design is considered for easy access by humans through the opening.

Reference

17.5 Paragraph 11 of the annex to MSC/Circ.686/Rev.1.

18 Towing and mooring equipment

(Source: MSC-MEPC.2/Circ.10)

Reg. 3-8

For single-hull oil tanker conversion into double-hull oil tanker or bulk carrier

This regulation should be applied when equipment and fittings for mooring/towing are replaced, modified or the safe working load of the existing equipment and fittings is known. Where the latter cannot be ascertained, alternative compliance with SOLAS regulation II-1/3-8 should be sought (e.g. the equipment should be replaced, tested or modified).

19 Subdivision and stability

(Source: MSC-MEPC.2/Circ.10)

Part B

19.1 For single-hull oil tanker conversion into double-hull oil tanker

Oil tankers complying with damage stability requirements contained in Annex I to MARPOL 73/78 (except for combination carriers with type B freeboards) may be excluded from the damage stability requirements contained in SOLAS chapter II-1, part B-1.

19.2 For single-hull oil tanker conversion into bulk carrier

19.2.1 A bulk carrier which is assigned a B reduced freeboard complying with damage stability requirements contained in regulation 27 of the 1966 Load Line Convention, and resolutions A.320(IX) and A.514(13); or regulation 27 of the 1988 Load Line Protocol, may be excluded from the damage stability requirements contained in SOLAS chapter II-1, part B-1.

19.2.2 For a bulk carrier which is assigned a B freeboard, SOLAS chapter II-1, parts B and B-1 should be applied.

20 Calculation of the factor s_f

(Source: MSC.1/Circ.1539/Rev.1)

Reg. 7-2

In applying θ_v , openings which cannot be or are incapable of being closed weathertight include ventilators (complying with regulation 19(4) of the *International Convention on Load Lines, 1966*) that for operational reasons have to remain open to supply air to the engine-room, emergency generator room or closed ro-ro and vehicle spaces (if the same is considered buoyant in the stability calculation or protecting openings leading below) for the effective operation of the ship. Where it is not technically feasible to treat some closed ro-ro and vehicle space ventilators as unprotected openings, Administrations may allow an alternative arrangement that provides an equivalent level of safety.

**21 Subdivision, watertight and weathertight integrity
Stability management**

(Source: MSC.1/Circ.1572)

Regs. 13,
13-1, 15-1, 17,
17-1 and 22

21.1 Doors in watertight bulkheads of passenger ships and cargo ships

This interpretation pertains to doors* located in way of the internal watertight subdivision boundaries and the external watertight boundaries necessary to ensure compliance with the relevant subdivision and damage stability regulations.

This interpretation does not apply to doors located in external boundaries above equilibrium or intermediate waterplanes.

The design and testing requirements for watertight doors vary according to their location relative to the equilibrium waterplane or intermediate waterplane at any stage of assumed flooding.

21.1.1 Definitions

For the purpose of this interpretation the following definitions apply:

21.1.1.1 Watertight: Capable of preventing the passage of water in any direction under a design head. The design head for any part of a structure should be determined by reference to its location relative to the bulkhead deck or freeboard deck, as applicable, or to the most unfavourable equilibrium/intermediate waterplane, in accordance with the applicable subdivision and damage stability regulations, whichever is the greater. A watertight door is thus one that will maintain the watertight integrity of the subdivision bulkhead in which it is located.

21.1.1.2 Equilibrium waterplane: The waterplane in still water when, taking account of flooding due to an assumed damage, the weight and buoyancy forces acting on a ship are in balance. This relates to the final condition when no further flooding takes place or after cross flooding is completed.

21.1.1.3 Intermediate waterplane: The waterplane in still water, which represents the instantaneous floating position of a ship at some intermediate stage between commencement and completion of flooding when, taking account of the assumed instantaneous state of flooding, the weight and buoyancy forces acting on a ship are in balance.

21.1.1.4 Sliding door or rolling door: A door having a horizontal or vertical motion generally parallel to the plane of the door.

21.1.1.5 Hinged door: A door having a pivoting motion about one vertical or horizontal edge.

21.2 Structural design

Doors and their frames should be of approved design and substantial construction in accordance with the requirements of the Administration and should preserve the strength of the subdivision bulkheads in which they are fitted.

21.3 Operation mode, location and outfitting

Doors should be fitted in accordance with all requirements regarding their operation mode, location and outfitting, i.e. provision of controls, means of indication, etc., as shown in table 1 below. This table should be read in conjunction with paragraphs 21.3.1 to 21.5.4 below.

21.3.1 Frequency of use whilst at sea

21.3.1.1 Normally closed: Kept closed at sea but may be used if authorized. To be closed again after use.

21.3.1.2 Permanently closed: The time of opening such doors in port and of closing them before the ship leaves port should be entered in the logbook. Should such doors be accessible during the voyage, they should be fitted with a device to prevent unauthorized opening.

21.3.1.3 Normally open: May be left open provided it is always ready to be immediately closed.

21.3.1.4 Used: In regular use, may be left open provided it is ready to be immediately closed.

21.3.2 Type

Power operated, sliding or rolling†	POS
Power operated, hinged	POH
Sliding or rolling	S
Hinged	H

* Doors in watertight bulkheads of small cargo ships, not subject to any statutory subdivision and damage stability requirements, may be hinged quick-acting doors arranged to open out of the major space protected. They should be constructed in accordance with the requirements of the Administration and have notices affixed to each side stating: "To be kept closed at sea".

† Rolling doors are technically identical to sliding doors.

21.3.3 Control**21.3.3.1 Local**

21.3.3.1.1 All doors, except those which should be permanently closed at sea, should be capable of being opened and closed by hand locally,* from both sides of the doors, with the ship listed to either side.

21.3.3.1.2 For passenger ships, the angle of list at which operation by hand should be possible is 15° or 20° if the ship is allowed to heel up to 20° during intermediate stages of flooding.

21.3.3.1.3 For cargo ships, the angle of list at which operation by hand should be possible is 30°.

21.3.3.2 Remote

Where indicated in table 1, doors should be capable of being remotely closed by power from the bridge.† Where it is necessary to start the power unit for operation of the watertight door, means to start the power unit is also to be provided at remote control stations. The operation of such remote control should be in accordance with regulations II-1/13.8.1 to II 1/13.8.3.

21.3.4 Indication

21.3.4.1 Where shown in table 1, position indicators should be provided at all remote operating positions‡ as well as locally, on both sides of the doors,§ to show whether the doors are open or closed and, if applicable, with all dogs/cleats fully and properly engaged.

21.3.4.2 The door position indicating system should be of self-monitoring type and the means for testing of the indicating system should be provided at the position where the indicators are fitted.

21.3.4.3 An indication (i.e. red light) should be placed locally showing that the door is in remote control mode ("doors closed mode"). Refer also to regulation II-1/13.8.1. Special care should be taken in order to avoid potential danger when passing through the door. Signboard/instructions should be placed in way of the door advising how to act when the door is in "doors closed" mode.

21.3.5 Alarms

21.3.5.1 Doors which should be capable of being remotely closed should be provided with an audible alarm, distinct from any other alarm in the area, which will sound whenever such a door is remotely closed. For passenger ships the alarm should sound for at least 5 seconds but not more than 10 seconds before the door begins to move and should continue sounding until the door is completely closed. In the case of remote closure by hand operation, an alarm is required to sound only while the door is actually moving.

21.3.5.2 In passenger areas and areas of high ambient noise, the audible alarms should be supplemented by visual signals at both sides of the doors.

21.3.6 Notices

As shown in table 1, doors which are normally closed at sea, but are not provided with means of remote closure, should have notices fixed to both sides of the doors stating: "To be kept closed at sea". Doors which should be permanently closed at sea should have notices fixed to both sides stating: "Not to be opened at sea".

21.3.7 Location

For passenger ships the watertight doors and their controls should be located in compliance with regulations II-1/13.5.3 and II-1/13.7.1.2.2.

21.4 Fire doors

21.4.1 Watertight doors may also serve as fire doors but need not be fire tested when intended for use below the bulkhead deck. Where such doors are used at locations above the bulkhead deck they should, in addition to complying with the provisions applicable to fire doors at the same locations, also comply with means of escape provisions of regulation II-2/13.

* Arrangements for passenger ships should be in accordance with regulation II-1/13.7.1.4.

† Arrangements for passenger ships should be in accordance with regulation II-1/13.7.1.5.

‡ Indication at all remote control positions (regulation II-1/13.6).

§ Refer to regulation II-1/13-1.3.

21.4.2 Where a watertight door is located adjacent to a fire door, both doors should be capable of independent operation, remotely if required by regulations II-1/13.8.1 to II-1/13.8.3 and from both sides of each door.

21.5 Testing

21.5.1 Doors which become immersed by an equilibrium or intermediate waterplane or are below the freeboard or bulkhead deck should be subjected to a hydrostatic pressure test.

21.5.2 For large doors intended for use in the watertight subdivision boundaries of cargo spaces, structural analysis may be accepted in lieu of pressure testing. Where such doors utilize gasket seals, a prototype pressure test to confirm that the compression of the gasket material is capable of accommodating any deflection, revealed by the structural analysis, should be carried out.

21.5.3 Doors above freeboard or bulkhead deck, which are not immersed by an equilibrium or intermediate waterplane but become intermittently immersed at angles of heel in the required range of positive stability beyond the equilibrium position, should be hose tested.

21.5.4 Pressure testing

21.5.4.1 The head of water used for the pressure test should correspond at least to the head measured from the lower edge of the door opening, at the location in which the door should be fitted in the ship, to the bulkhead deck or freeboard deck, as applicable, or to the most unfavourable damage waterplane, if that be greater. Testing may be carried out at the factory or other shore-based testing facility prior to installation in the ship.

21.5.4.2 Leakage criteria

21.5.4.2.1 The following acceptable leakage criteria should apply:

Doors with gaskets	No leakage
Doors with metallic sealing	Maximum leakage 1 L/min

21.5.4.2.2 Limited leakage may be accepted for pressure tests on large doors located in cargo spaces employing gasket seals or guillotine doors located in conveyor tunnels, in accordance with the following:*

$$\text{Leakage rate (L/min)} = \frac{(P + 4.572)h^3}{6568}$$

where P = perimeter of door opening (metres)

h = test head of water (metres)

21.5.4.2.3 However, in the case of doors where the water head taken for the determination of the scantling does not exceed 6.1 m, the leakage rate may be taken equal to 0.375 L/min if this value is greater than that calculated by the above-mentioned formula.

21.5.4.3 For doors of passenger ships which are normally open and used at sea and which become submerged by the equilibrium or intermediate waterplane, a prototype test should be conducted, on each side of the door, to check the satisfactory closing of the door against a force equivalent to a water height of at least 1 m above the sill on the centre line of the door.†

21.5.5 Hose testing after installation

All watertight doors should be subject to a hose test‡ after installation in a ship. Hose testing should be carried out from each side of a door unless, for a specific application, exposure to floodwater is anticipated only from one side. Where a hose test is not practicable because of possible damage to machinery, electrical equipment insulation, or outfitting items, it may be replaced by means such as an ultrasonic leak test or an equivalent test.

* Published in the ASTM F1196, *Standard Specification for Sliding Watertight Door Assemblies* and referenced in the Title 46 US Code of Federal Regulations 170.270 Door design, operation, installation, and testing.

† Arrangements for passenger ships should be in accordance with regulation II-1/13.5.2.

‡ Refer to IACS UR S14.2.3 IACS Reg. 1996/Rev.2, 2001.

Table 1 – Internal doors in watertight bulkheads in cargo ships and passenger ships

Position relative to equilibrium or intermediate waterplane	1 Frequency of use whilst at sea	2 Type	3 Remote control ⁶	4 Indication locally and on bridge ⁶	5 Audible alarm ⁶	6 Notice	7 Comments	8 Regulation
I. Passenger ships								
A. At or below	Normally closed	POS	Yes	Yes	Yes	No	Certain doors may be left open, see regulation II-1/22.4	II-1/22.1 to II-1/22.4
	Permanently closed	S, H	No	No	No	Yes	See Notes 1 + 4	II-1/13.9.1 and II-1/13.9.2
B. Above	Normally open	POS, POH	Yes	Yes	Yes	No		II-1/22.4 II-1/17.1 MSC/Circ.541
	Normally closed	S, H S, H	No No	Yes Yes	No No	Yes Yes	See Note 2 Doors giving access to ro-ro deck	II-1/17-1
II. Cargo ships								
A. At or below	Used	POS	Yes	Yes	Yes	No		II-1/13-1.2
	Normally closed	S, H	No	Yes	No	Yes	see Notes 2 + 3 + 5	II-1/13-1.3
B. Above	Permanently closed	S, H	No	No	No	Yes	see Notes 1 + 4	II-1/13-1.4 II-1/15-1
	Used	POS	Yes	Yes	Yes	No		II-1/13-1.2
	Normally closed	S, H	No	Yes	No	Yes	See Notes 2 + 5	II-1/13-1.3 II-1/15-1

Notes:

- 1 Doors in watertight bulkheads subdividing cargo spaces.
- 2 If hinged, this door should be of quick-acting or single-action type.
- 3 SOLAS requires remotely operated watertight doors to be sliding doors.
- 4 The time of opening such doors in port and closing them before the ship leaves port should be entered in the logbook.
- 5 The use of such doors should be authorized by the officer of the watch.
- 6 Cables for control and power systems to power-operated watertight doors and their status indication should comply with the requirements of IACS UR E15.

22 Integrity of the hull and superstructure, damage prevention and control on ro-ro passenger ships/Loading of ships *(Source: MSC.1/Circ.1571)*

- Reg. 17-1.1.1** 22.1 Stern, bow and side doors of large dimensions, when manual devices would not be readily accessible, should be normally secured by means of power systems.
- 22.2 Alternative means of securing should also be provided for emergency use in case of failure of the power systems.
- 22.3 In ro-ro passenger ships constructed before 1 July 1997, all access doors or hatchways to spaces below the ro-ro deck, which may be used at sea, should have sills or coamings not less than 380 mm in height above the ro-ro deck, and should be provided with doors or covers considered weathertight in relation to their position; refer to SOLAS regulation II-1/20.2.
- 22.4 For ro-ro passenger ships constructed on or after 1 July 1997 but before 1 January 2009, refer to SOLAS regulation II-1/20-2.
- 22.5 The ro-ro deck, referred to in paragraph 3 above, is the deck above which the stern, bow or side doors are fitted, or the first deck above the load waterline.

23 Flooding detection systems for passenger ships carrying 36 or more persons *(Source: MSC.1/Circ.1539/Rev.1)*

- Reg. 22-1** For passenger ships carrying 36 or more persons and subject to SOLAS regulation II-1/8-1, the Safe Return To Port (SRTP) requirements of SOLAS regulation II-2/21.4 apply to both:
- .1 the flooding detection systems in the spaces as defined in paragraph 6 of MSC.1/Circ.1291; and
 - .2 the liquid level monitoring systems, which are used as, or replace, the flooding detection systems, as specified in paragraph 7 of MSC.1/Circ.1291.

Therefore, for systems noted in sub-paragraph .2 above, the phrase "excluded from these requirements" in paragraph 7 of MSC.1/Circ.1291 is not an exclusion from the general provision in SOLAS regulation II-2/21.4.13 (remain operational in the event of fire). This exclusion pertains only to the detailed provisions in MSC.1/Circ.1291.

24 Fuel pump arrangement required for ships to maintain normal operation of propulsion machinery when operating in emission control areas and non-restricted areas *(Source: MSC.1/Circ.1467)*

- Reg. 26.3.4** 24.1 For ships intending to use heavy fuel oil (HFO) or marine diesel oil (MDO) in non-restricted areas and marine fuels with a sulphur content not exceeding 0.1 per cent/m/m and minimum viscosity of 2 cSt in emission control areas, the following arrangements should be considered to be in compliance with SOLAS regulation II-1/26.3.4:
- .1 in non-restricted areas, ships provided with two fuel oil pumps that can each supply the fuel primarily used by the ship (i.e. HFO or MDO) in the required capacity for normal operation of the propulsion machinery; and
 - .2 in emission control areas one of the following configurations:
 - .1 fuel oil pumps as in .1, provided these are each suitable for marine fuels with a sulphur content not exceeding 0.1 per cent/m/m and minimum viscosity of 2 cSt operation at the required capacity for normal operation of propulsion machinery;
 - .2 when the fuel oil pumps in .1 are suitable to operate on marine fuels with a sulphur content not exceeding 0.1 per cent/m/m and minimum viscosity of 2 cSt but one pump alone is not capable of delivering marine fuels with a sulphur content not exceeding 0.1 per cent/m/m and minimum viscosity of 2 cSt at the required capacity, then both pumps may operate in parallel to achieve the required capacity for normal operation of propulsion machinery. In this case, one additional (third) fuel oil pump should be provided. The additional pump should, when operating in parallel with one of the pumps in .1, be suitable for and capable of delivering marine fuels with a sulphur content not exceeding 0.1 per cent/m/m and minimum viscosity of 2 cSt at the required capacity for normal operation of the propulsion machinery; and
 - .3 in addition to .1, two separate fuel oil pumps should be provided, each capable of and suitable for supplying marine fuels with a sulphur content not exceeding 0.1 per cent/m/m and minimum viscosity of 2 cSt at the required capacity for normal operation of propulsion machinery.

Notes:

- 1 For the purpose of this interpretation, if a marine distillate grade fuel with a different maximum sulphur content is specified by regulation for the area of operation of the ship (e.g. ECA, specific ports or local areas, etc.) then that maximum should be applied.
- 2 IACS UR35.4.1 (automatic start of standby pumps) applies independent of the pump arrangement for ships holding the class notation for unattended machinery space.
- 3 Where electrical power is required for the operation of propulsion machinery, the requirements should also be applicable for machinery for power generation when such machinery is supplied by common fuel supply pumps.

25 Machinery installations – General*(Source: MSC.1/Circ.1572)*

Reg. 26.4 25.1 Dead ship condition for the purpose of regulation II-1/26.4 should be understood to mean a condition under which the main propulsion plant, boilers and auxiliaries are not in operation and in restoring the propulsion, no stored energy for starting and operating the propulsion plant, the main source of electrical power and other essential auxiliaries is assumed to be available.

25.2 Where the emergency source of power is an emergency generator which complies with regulation II-1/44, IACS SC185 and IACS SC124, this generator may be used for restoring operation of the main propulsion plant, boilers and auxiliaries where any power supplies necessary for engine operation are also protected to a similar level as the starting arrangements.

25.3 Where there is no emergency generator installed or an emergency generator does not comply with regulation II-1/44, the arrangements for bringing main and auxiliary machinery into operation should be such that the initial charge of starting air or initial electrical power and any power supplies for engine operation can be developed on board ships without external aid. If for this purpose an emergency air compressor or an electric generator is required, these units should be powered by a hand-starting oil engine or a hand-operated compressor. The arrangements for bringing main and auxiliary machinery into operation should have capacity such that the starting energy and any power supplies for engine operation are available within 30 min of a dead ship condition.

26 Machinery installations – General*(Source: MSC.1/Circ.1572)*

Reg. 26.11 26.1 Arrangements complying with this regulation and acceptable “equivalent arrangements”, for the most commonly utilized fuel systems, are shown in appendix 1.

26.2 A service tank is a fuel oil tank which contains only fuel of a quality ready for use, i.e. fuel of a grade and quality that meets the specification required by the equipment manufacturer. A service tank should be declared as such and not be used for any other purpose.

26.3 Use of a setting tank with or without purifiers, or purifiers alone, and one service tank is not acceptable as an “equivalent arrangement” to two service tanks.

27 Means of going astern**(Source: MSC.1/Circ.1416/Rev.1)*

Reg. 28.3 The stopping times, ship headings and distances recorded on trials, together with the results of trials to determine the ability of ships having multiple propulsion/steering arrangements to navigate and manoeuvre with one or more of these devices inoperative, should be available on board for the use of the master or designated personnel.

28 Steering gear*(Source: MSC.1/Circ.1398)*

Reg. 29 28.1 Basic requirements

28.1.1 Two independent steering gear control systems should be provided and should be so arranged that a mechanical or electrical failure in one of them will not render the other one inoperative.

* The SOLAS requirements for steering gears have been established for ships having a traditional propulsion system and one rudder. For ships fitted with alternative propulsion and steering arrangements, such as but not limited to, azimuthing propulsors or water jet propulsion systems, SOLAS regulations II-1/28.2, 28.3, 29.1, 29.2.1, 29.3, 29.4, 29.6.1, 29.14 and 30.2 should be interpreted as follows, except 29.14, which is limited to the steering systems having a certain steering capability due to ship speed also in case propulsion power has failed.

28.1.2 The term "steering gear control system" as defined in SOLAS chapter II-1, part A, regulation 3.1, should be understood as "steering control system" covering "the equipment required to control the steering gear power actuating system".

28.2 Separation of control systems and components

28.2.1 General

Wires, terminals and the components for duplicated steering gear control systems installed in units, control boxes, switchboards or bridge consoles should be separated as far as practicable. Where physical separation is not practicable, separation may be achieved by means of a fire retardant plate.

28.2.2 Steering wheel or steering lever

All electric components of the steering gear control systems should be duplicated. This does not require duplication of the steering wheel or steering lever.

28.2.3 Steering mode selector switch

If a joint steering mode selector switch (uniaxial switch) is employed for both steering gear control systems, the connections for the circuits of the control systems should be divided accordingly and separated from each other by an isolating plate or by air gap.

28.2.4 Follow-up amplifier

In the case of double follow-up control (see appendix 2, example 2), the amplifiers should be designed and fed so as to be electrically and mechanically separated. In the case of non follow-up control and follow-up control, it should be ensured that the follow-up amplifiers are protected selectively (see appendix 2, example 3).

28.2.5 Additional control systems

Control circuits for additional control systems, e.g. steering lever or autopilot, should be designed for all-pole disconnection (see appendix 2, examples 1, 2 and 3).

28.2.6 Feed-back units and limit switches

The feed-back units and limit switches, if any, for the steering gear control systems should be separated electrically and mechanically connected to the rudder stock or actuator separately.

28.2.7 Hydraulic control components

28.2.7.1 Hydraulic system components in the power actuating or hydraulic servo systems controlling the power systems of the steering gear (e.g. solenoid valves, magnetic valves) should be considered as part of the steering gear control system and should be duplicated and separated.

28.2.7.2 Hydraulic system components in the steering gear control system that are part of a power unit may be regarded as being duplicated and separated when there are two or more separate power units provided and the piping to each power unit can be isolated.

28.3 Failure detection and response of control systems

28.3.1 Failure detection

28.3.1.1 The most probable failures that may cause reduced or erroneous system performance should be detected, and should consider at least the following:

- .1 power supply failure;
- .2 loop failures in closed loop systems, both command and feedback loops (normally short circuit, broken connections and earth faults);
- .3 if programmable electronic systems are used:
 - .1 data communication errors; and
 - .2 computer hardware and software failures; and
- .4 hydraulic locking considering order given by steering wheel or lever.

28.3.1.2 All failures detected should initiate an audible and visual alarm on the navigation bridge. Hydraulic locking should always be warned individually unless system design makes manual action unnecessary.

Note: "Hydraulic locking" includes all situations where two hydraulic systems (usually identical) oppose each other in such a way that it may lead to loss of steering. It can either be caused by pressure in the two hydraulic systems working against each other or by hydraulic "by pass" meaning that the systems puncture each other and cause pressure drop on both sides or make it impossible to build up pressure.

28.3.1.3 Alternatively to 28.3.1.1.2 and 28.1.1.3, depending on the rudder characteristic, critical deviations between rudder order and response should be indicated visually and audibly as steering failure alarm on the navigating bridge.

28.3.1.4 The following parameters should be monitored:

- .1 *Direction:* Actual rudder position follows the set value.
- .2 *Delay:* Rudder's actual position reaches set position within acceptable time limits.
- .3 *Accuracy:* The end actual position should correspond to the set value within the design offset tolerances.

28.3.2 System response upon failure

The most probable failures, e.g. loss of power or loop failure, should result in the least critical of any new possible conditions.

29 Steering gear*

(Source: MSC.1/Circ.1416/Rev.1)

Reg. 29.1 29.1 For a ship fitted with multiple steering-propulsion units, such as, but not limited to, azimuthing propulsors or water jet propulsion systems, each of the steering-propulsion units should be provided with a main steering gear and an auxiliary steering gear or with two or more identical steering actuating systems in compliance with interpretation of SOLAS regulation II-1/29.6.1 (see Interpretation 34). The main steering gear and the auxiliary steering gear should be so arranged that the failure of one of them will not render the other one inoperative.

29.2 For a ship fitted with a single steering-propulsion unit, the requirement in SOLAS regulation II-1/29.1 is considered satisfied if the steering gear is provided with two or more steering actuating systems and is in compliance with interpretation of SOLAS regulation II-1/29.6.1 (see Interpretation 34). A detailed risk assessment should be submitted in order to demonstrate that in the case of any single failure in the steering gear, control system and power supply the ship steering is maintained.

30 Steering gear*

(Source: MSC.1/Circ.1416/Rev.1)

Reg. 29.2.1 All components used in steering arrangements for ship directional control should be of sound reliable construction to the satisfaction of the Administration or recognized organizations acting on its behalf. Special consideration should be given to the suitability of any essential component which is not duplicated. Any such essential component should, where appropriate, utilize anti-friction bearings such as ball bearings, roller bearings or sleeve bearings which should be permanently lubricated or provided with lubrication fittings.

31 Steering gear

(Source: MSC.1/Circ.1536)

Regs. 29.3, 29.4 31.1 In order for ships to comply with the performance requirements stated in regulations II 1/29.3.2 and 29.4.2, they are to have steering gear capable of meeting these performance requirements when at their deepest seagoing draught.

31.2 In order to demonstrate this ability, the trials may be conducted in accordance with section 6.1.5.1 of the standard ISO 19019:2005 (*Sea-going vessels and marine technology – Instructions for planning, carrying out and reporting sea trials*).

31.3 On all occasions when trials are conducted with the vessel not at the deepest seagoing draught, the loading condition can be accepted on the conditions that either:

- .1 The rudder is fully submerged (at zero speed waterline) and the vessel is in an acceptable trim condition.

* The SOLAS requirements for steering gears have been established for ships having a traditional propulsion system and one rudder. For ships fitted with alternative propulsion and steering arrangements, such as but not limited to, azimuthing propulsors or water jet propulsion systems, SOLAS regulations II-1/28.2, 28.3, 29.1, 29.2.1, 29.3, 29.4, 29.6.1, 29.14 and 30.2 should be interpreted as follows, except 29.14, which is limited to the steering systems having a certain steering capability due to ship speed also in case propulsion power has failed.

- .2 The rudder torque at the trial loading condition has been reliably predicted (based on the system pressure measurement) and extrapolated to the maximum seagoing draught condition using the following method to predict the equivalent torque and actuator pressure at the deepest seagoing draught:

$$Q_F = Q_T \alpha$$

$$\alpha = 1.25 \left(\frac{A_F}{A_T} \right) \left(\frac{V_F}{V_T} \right)^2$$

where:

α is the Extrapolation factor.

Q_F is the rudder stock moment (torque in the rudder stock) for the deepest service draught and maximum service speed condition.

Q_T is the rudder stock moment (torque in the rudder stock) for the trial condition.

A_F is the total immersed projected area of the movable part of the rudder in the deepest seagoing condition.

A_T is the total immersed projected area of the movable part of the rudder in the trial condition.

V_F is the contractual design speed of the vessel corresponding to the maximum continuous revolutions of the main engine at the deepest seagoing draught.

V_T is the measured speed of the vessel (considering current) in the trial condition.

Where the rudder actuator system pressure is shown to have a linear relationship to the rudder stock torque the above equation can be taken as:

$$P_F = P_T \alpha$$

where:

P_F is the estimated steering actuator hydraulic pressure in the deepest seagoing draught condition.

P_T is the maximum measured actuator hydraulic pressure in the trial condition.

Where constant volume fixed displacement pumps are utilized then the regulations can be deemed satisfied if the estimated steering actuator hydraulic pressure at the deepest draught is less than the specified maximum working pressure of the rudder actuator. Where a variable delivery pump is utilized pump data should be supplied and interpreted to estimate the delivered flow rate corresponds to the deepest seagoing draught in order to calculate the steering time and allow it to be compared to the required time.

Where A_T is greater than $0.95A_F$ there is no need for extrapolation methods to be applied.

- .3 Alternatively, the designer or builder may use computational fluid dynamic (CFD) studies or experimental investigations to predict the rudder stock moment at the full seagoing draught condition and service speed. These calculations or experimental investigations should be to the satisfaction of the Administration.

31.4 In any case for the main steering gear trial, the speed of the ship corresponding to the number of maximum continuous revolution of main engine and maximum design pitch applies.

32 Steering gear*

(Source: MSC.1/Circ.1416/Rev.1)

Reg. 29.3

32.1 The main steering arrangements for ship directional control should be:

- .1 of adequate strength and capable of steering the ship at maximum ahead service speed which should be demonstrated;
- .2 capable of changing direction of the steering-propulsion unit from one side to the other at declared steering angle limits at an average turning speed of not less than 2.3°/s with the ship running ahead at maximum ahead service speed;
- .3 for all ships, operated by power; and
- .4 so designed that they will not be damaged at maximum astern speed; this design requirement need not be proved by trials at maximum astern speed and declared steering angle limits.

* The SOLAS requirements for steering gears have been established for ships having a traditional propulsion system and one rudder. For ships fitted with alternative propulsion and steering arrangements, such as but not limited to, azimuthing propulsors or water jet propulsion systems, SOLAS regulations II-1/28.2, 28.3, 29.1, 29.2.1, 29.3, 29.4, 29.6.1, 29.14 and 30.2 should be interpreted as follows, except 29.14, which is limited to the steering systems having a certain steering capability due to ship speed also in case propulsion power has failed.

Ship manoeuvrability tests, such as according to resolution MSC.137(76) on *Standards for ship manoeuvrability*, should be carried out with steering angles not exceeding the declared steering angle limits.

Definition: *Declared steering angle limits* are the operational limits in terms of maximum steering angle, or equivalent, according to manufacturers' guidelines for safe operation, also taking into account the ship's speed or propeller torque/speed or other limitation; the "declared steering angle limits" are to be declared by the directional control system manufacturer for each ship specific non-traditional steering gear; ship manoeuvrability tests, such as those in the *Standards for ship manoeuvrability* (resolution MSC.137(76)) should be carried out with steering angles not exceeding the declared steering angle limits.

33 Steering gear* (Source: MSC.1/Circ.1416/Rev.1)

- Reg. 29.4 33.1 The auxiliary steering arrangements for ship directional control should be:
- .1 of adequate strength and capable of steering the ship at navigable speed and of being brought speedily into action in an emergency;
 - .2 capable of changing direction of the ship's directional control system from one side to the other at declared steering angle limits at an average turning speed, of not less than 0.5°/s; with the ship running ahead at one half of the maximum ahead service speed or 7 knots, whichever is the greater; and
 - .3 for all ships, operated by power where necessary to meet the requirements of SOLAS regulation II-1/29.4.2 and in any ship having power of more than 2,500 kW propulsion power per steering-propulsion unit.

Ship manoeuvrability tests, such as according to resolution MSC.137(76), should be carried out with steering angles not exceeding the declared steering angle limits.

Definition: *Declared steering angle limits* are the operational limits in terms of maximum steering angle, or equivalent, according to manufacturers' guidelines for safe operation, also taking into account the ship's speed or propeller torque/speed or other limitation; the "declared steering angle limits" are to be declared by the directional control system manufacturer for each ship specific non-traditional steering gear; ship manoeuvrability tests, such as those in the *Standards for ship manoeuvrability* (resolution MSC.137(76)) should be carried out with steering angles not exceeding the declared steering angle limits.

34 Steering gear* (Source: MSC.1/Circ.1416/Rev.1)

- Reg. 29.6.1 34.1 For a ship fitted with a single steering-propulsion unit where the main steering gear comprises two or more identical power units and two or more identical steering actuators, an auxiliary steering gear need not be fitted provided that the steering gear:
- .1 in a passenger ship, is capable of satisfying the requirements in interpretation to SOLAS regulation II-1/29.3 (see Interpretations 31 and 32) while any one of the power units is out of operation;
 - .2 in a cargo ship, is capable of satisfying the requirements in interpretation to SOLAS regulation II-1/29.3 (see Interpretations 31 and 32) while operating with all power units; and
 - .3 is arranged so that after a single failure in its piping system or in one of the power units, steering capability can be maintained or speedily regained.
- 29.2 For a ship fitted with multiple steering-propulsion units, where each main steering system comprises two or more identical steering actuating systems, an auxiliary steering gear need not be fitted provided that each steering gear:
- .1 in a passenger ship, is capable of satisfying the requirements in interpretation to SOLAS regulation II-1/29.3 (see Interpretations 31 and 32) while any one of the steering gear steering actuating systems is out of operation;
 - .2 in a cargo ship, is capable of satisfying the requirements in interpretation to SOLAS regulation II-1/29.3 (see Interpretations 31 and 32) while operating with all steering gear steering actuating systems;

* The SOLAS requirements for steering gears have been established for ships having a traditional propulsion system and one rudder. For ships fitted with alternative propulsion and steering arrangements, such as but not limited to, azimuthing propulsors or water jet propulsion systems, SOLAS regulations II-1/28.2, 28.3, 29.1, 29.2.1, 29.3, 29.4, 29.6.1, 29.14 and 30.2 should be interpreted as follows, except 29.14, which is limited to the steering systems having a certain steering capability due to ship speed also in case propulsion power has failed.

- .3 is arranged so that after a single failure in its piping or in one of the steering actuating systems, steering capability can be maintained or speedily regained; and
- .4 the above capacity requirements apply regardless whether the steering systems are arranged with common or dedicated power units.

Definition: Steering gear power unit – For the purposes of alternative steering arrangements, the steering gear power unit should be considered as defined in SOLAS regulation II-1/3. For electric steering gears, refer to SOLAS regulation II-1/3; electric steering motors should be considered as part of the power unit and actuator.

35 Steering gear* (Source: MSC.1/Circ.1416/Rev.1)

Reg. 29.14 This interpretation is valid to steering-propulsion units having a certain proven steering capability due to ship speed also in case propulsion power has failed.

Where the propulsion power exceeds 2,500 kW per thruster unit, an alternative power supply, sufficient at least to supply the steering arrangements which complies with the requirements of SOLAS regulation II-1/29.4.2 and also its associated control system and the steering gear response indicator, should be provided automatically, within 45 s, either from the emergency source of electrical power or from an independent source of power located in the steering gear compartment. This independent source of power should be used only for this purpose. In every ship of 10,000 gross tonnage and upwards, the alternative power supply should have a capacity for at least 30 min of continuous operation and in any other ship for at least 10 min.

36 Additional requirements for electric and electrohydraulic steering gear* (Source: MSC.1/Circ.1416/Rev.1)

Reg. 30.2 For a ship fitted with multiple steering systems, the requirements in SOLAS regulation II-1/30.2 are to be applied to each of the steering systems.

37 Passenger ships and cargo ships (Source: MSC.1/Circ.1571)

Reg. 35-1.2.6.1 The drainage of enclosed spaces situated on the bulkhead deck to suitable spaces below the bulkhead deck is also permitted provided such drainage is arranged in accordance with the provisions of regulation 22(2) of the Protocol of 1988 relating to the International Convention on Load Lines, 1966.

38 General/Main source of electrical power and lighting systems (Source: MSC.1/Circ.1572)

Regs. 40, 41 38.1 Essential services and arrangements of sources of power, supply, control and monitoring to the different categories of essential services

38.1.1 Classification of essential services

38.1.1.1 Essential services are those services essential for propulsion and steering, and safety of the ship, which are made up of "Primary Essential Services" and "Secondary Essential Services". Definitions and examples of such services are given in 38.2 and 38.3 below.

38.1.1.2 Services to ensure minimum comfortable conditions of habitability are those services defined in 38.4 below.

38.2 Primary Essential Services

Primary Essential Services are those services which need to be in continuous operation to maintain propulsion and steering. Examples of equipment for "Primary Essential Services" are as follows:

- steering gears;
- pumps for controllable pitch propellers;
- scavenging air blower, fuel oil supply pumps, fuel valve cooling pumps, lubricating oil pumps and cooling water pumps for main and auxiliary engines and turbines necessary for propulsion;

* The SOLAS requirements for steering gears have been established for ships having a traditional propulsion system and one rudder. For ships fitted with alternative propulsion and steering arrangements, such as but not limited to, azimuthing propulsors or water jet propulsion systems, SOLAS regulations II-1/28.2, 28.3, 29.1, 29.2.1, 29.3, 29.4, 29.6.1, 29.14 and 30.2 should be interpreted as follows, except 29.14, which is limited to the steering systems having a certain steering capability due to ship speed also in case propulsion power has failed.

- forced draught fans, feed water pumps, water circulating pumps, vacuum pumps and condensate pumps for steam plants on steam turbine ships, and also for auxiliary boilers on ships where steam is used for equipment supplying primary essential services;
- oil burning installations for steam plants on steam turbine ships and for auxiliary boilers where steam is used for equipment supplying primary essential services;
- azimuth thrusters, which are the sole means for propulsion/steering with lubricating oil pumps, cooling water pumps;
- electrical equipment for electric propulsion plant with lubricating oil pumps and cooling water pumps;
- electric generators and associated power sources supplying the above equipment;
- hydraulic pumps supplying the above equipment;
- viscosity control equipment for heavy fuel oil;
- control, monitoring, and safety devices/systems for equipment to primary essential services;
- fire pumps and other fire extinguishing medium pumps;
- navigation lights, aids and signals;
- internal safety communication equipment; and
- lighting system.

38.3 Secondary Essential Services

Secondary Essential Services are those services which need not necessarily be in continuous operation to maintain propulsion and steering but which are necessary for maintaining the vessel's safety. Examples of equipment for secondary essential services are as follows:

- windlass;
- fuel oil transfer pumps and fuel oil treatment equipment;
- lubrication oil transfer pumps and lubrication oil treatment equipment;
- pre-heaters for heavy fuel oil;
- starting air and control air compressors;
- bilge, ballast and heeling pumps;
- ventilating fans for engine and boiler rooms;
- services considered necessary to maintain dangerous spaces in a safe condition;
- fire detection and alarm system;
- electrical equipment for watertight closing appliances;
- electric generators and associated power sources supplying the above equipment;
- hydraulic pumps supplying the above equipment;
- control, monitoring, and safety systems for cargo containment systems; and
- control, monitoring, and safety devices/systems for equipment to secondary essential services.

38.4 Services for habitability

Services for habitability are those services which need to be in operation for maintaining the ship's minimum comfort conditions for the crew and passengers. Examples of equipment for maintaining conditions of habitability are as follows:

- cooking;
- heating;
- domestic refrigeration;
- mechanical ventilation;
- sanitary and fresh water; and
- electrical generators and associated power sources supplying the above equipment.

38.5 *Regulations II-1/40.1.1 and II-1/41.1.1* – For the purposes of these regulations, the services as included in paragraphs 33.2 to 33.4 should be considered.

38.6 *Regulation II-1/40.1.2* – For the purposes of this regulation, the services as included in paragraphs 38.2 and 38.3 and the services in regulations II-1/42 or II-1/43, as applicable, should be considered.

38.7 *Regulation II-1/41.1.2* – For the purposes of this regulation, the services as included in paragraphs 38.2 to 38.4, except for those also listed in Interpretation 39, should be considered.

38.8 *Regulation II-1/41.1.5* – For the purposes of this regulation, the services as included in paragraphs 38.2, 38.3 and 38.4 should be considered.*

38.9 *Regulation II-1/41.5.1.2* – For the purposes of this regulation, the following interpretations are applicable:

- .1 services in paragraph 38.2 should not be included in any automatic load shedding or other equivalent arrangements;
- .2 services in paragraph 38.3 may be included in the automatic load shedding or other equivalent arrangement provided disconnection will not prevent services required for safety being immediately available when the power supply is restored to normal operating conditions; and
- .3 services for habitability in paragraph 38.4 may be included in the load shedding or other equivalent arrangement.

39 Main source of electrical power and lighting systems (Source: MSC.1/Circ.1572)

Reg. 41.1.2 Those services necessary to provide normal operational conditions of propulsion and safety do not include services such as:

- .1 thrusters not forming part of the main propulsion;
- .2 moorings;
- .3 cargo handling gear;
- .4 cargo pumps; and
- .5 refrigerators for air conditioning (those which are not necessary to establish a minimum condition of habitability).

40 Main source of electrical power and lighting systems (Source: MSC.1/Circ.1572)

Reg. 41.1.3 Generators and generator systems, having the ship's main propulsion machinery as their prime mover, may be accepted as part of the ship's main source of electrical power, provided that:

- .1 they are capable of operating under all weather conditions during sailing and during manoeuvring, also when the ship is stopped, within the specified limits for the voltage variation in IEC 60092-301 and the frequency variation in IACS UR E5;
- .2 their rated capacity is safeguarded during all operations given under 1, and is such that in the event of any other one of the generators failing, the services given under regulation II-1/41.1.2 (see Interpretation 39) can be maintained;
- .3 the short circuit current of the generator/generator system is sufficient to trip the generator/generator system circuit-breaker taking into account the selectivity of the protective devices for the distribution system. Protection should be arranged in order to safeguard the generator/generator system in case of a short circuit in the main busbar. The generator/generator system should be suitable for further use after fault clearance; and
- .4 standby sets are started in compliance with paragraph 2 of the interpretation of regulation II-1/41.5.1.1 (see Interpretation 41.2 below).

41 Main source of electrical power and lighting systems (Source: MSC.1/Circ.1572)

Reg. 41.5.1.1 41.1 Where the electrical power is normally supplied by more than one generator set simultaneously in parallel operation, provision of protection, including automatic disconnection of sufficient non-essential services and, if necessary, secondary essential services as defined in the unified interpretation of SOLAS regulations II-1/40 and II-1/41 (see Interpretation 38) and those provided for habitability, should be made to ensure that, in case of loss of any of these generating sets, the remaining ones are kept in operation to permit propulsion and steering and to ensure safety.

41.2 Where Administrations permit electrical power to be normally supplied by one generator, provision should be made, upon loss of power, for automatic starting and connecting to the main switchboard of stand-by generator(s) of sufficient capacity with automatic restarting of the essential auxiliaries, in sequential operation if required. Starting and connection to the main switchboard of one generator should be as rapid as possible, preferably within 30 sec after loss of power. Where prime movers with

* See also IACS UI SC83.

longer starting time are used, this starting and connection time may be exceeded upon approval from the Administration.

42 Main source of electrical power and lighting systems (Source: MSC.1/Circ.1572)

Reg. 41.5.1.2 42.1 The load shedding should be automatic.

42.2 The non-essential services, service for habitable conditions, may be shed and, where necessary, additionally the Secondary Essential Services, sufficient to ensure the connected generator set(s) is/are not overloaded.

43 Main source of electrical power and lighting systems (Source: MSC.1/Circ.1572)

Reg. 41.5.1.3 43.1 Other approved means can be achieved by:

- .1 circuit breaker without tripping mechanism; or
- .2 disconnecting link or switch by which busbars can be split easily and safely.

43.2 Bolted links, for example bolted busbar sections, should not be accepted.

44 Emergency source of electrical power in passenger and cargo ships (Source: MSC.1/Circ.1572)

Regs. 42, 43 44.1 "Blackout" as used in regulations II-1/42.3.4 and II-1/43.3.4 should be understood to mean a "dead ship" condition-initiating event.

44.2 "Dead ship" condition, for the purpose of regulations II-1/42.3.4 and II-1/43.3.4, should be understood to mean a condition under which the main propulsion plant, boilers and auxiliaries are not in operation and in restoring the propulsion, no stored energy for starting the propulsion plant, the main source of electrical power and other essential auxiliaries should be assumed available. It is assumed that means are available to start the emergency generator at all times.

44.3 Emergency generator stored starting energy is not to be directly used for starting the propulsion plant, the main source of electrical power and/or other essential auxiliaries (emergency generator excluded).

44.4 For steam ships, the 30-min time limit given in SOLAS can be interpreted as time from blackout defined above to light-off of the first boiler.

44.5 "Exceptionally" is understood to mean conditions such as:

- .1 blackout situation;
- .2 dead ship situation;
- .3 routine use for testing;
- .4 short-term parallel operation with the main source of electrical power for the purpose of load transfer; and
- .5 use of the emergency generator during lay time in port for the supply of the ship's main switchboard, provided the requirements of 44.6 (Suitable measures for the exceptional use of the emergency generator for power supply of non-emergency circuits in port) are achieved and unless instructed otherwise by the Administration.

44.6 Suitable measures for the exceptional use of the emergency generator for power supply of non-emergency circuits in port:

- .1 To prevent the generator or its prime mover from becoming overloaded when used in port, arrangements should be provided to shed sufficient non-emergency loads to ensure its continued safe operation.
- .2 The prime mover should be arranged with fuel oil filters and lubrication oil filters, monitoring equipment and protection devices as required for the prime mover for main power generation and for unattended operation.
- .3 The fuel oil supply tank to the prime mover should be provided with a low-level alarm, arranged at a level ensuring sufficient fuel oil capacity for the emergency services for the period of time as required by SOLAS.
- .4 The prime mover should be designed and built for continuous operation and should be subjected to a planned maintenance scheme ensuring that it is always available and capable of fulfilling its role in the event of an emergency at sea.

- .5 Fire detectors should be installed in the location where the emergency generator set and emergency switchboard are installed.
- .6 Means should be provided to readily change over to emergency operation.
- .7 Control, monitoring and supply circuits for the purpose of the use of emergency generator in port should be so arranged and protected that any electrical fault will not influence the operation of the main and emergency services.
- .8 When necessary for safe operation, the emergency switchboard should be fitted with switches to isolate the circuits.
- .9 Instructions should be provided on board to ensure that when the ship is under way all control devices (e.g. valves, switches) are in a correct position for the independent emergency operation of the emergency generator set and emergency switchboard.

45 Starting arrangements for emergency generating sets (Source: MSC.1/Circ.1572)

Reg. 44.1 Emergency generating sets should be capable of being readily started in their cold condition at a temperature of 0°C. If this is impracticable, or if lower temperatures are likely to be encountered, heating should be provided to ensure ready starting of the generating sets.

46 Starting arrangements for emergency generating sets (Source: MSC.1/Circ.1572)

Reg. 44.2 Each emergency generating set arranged to be automatically started should be equipped with starting devices with a stored energy capability of at least three consecutive starts. A second source of energy should be provided for an additional three starts within 30 min unless manual starting can be demonstrated to be effective.

47 Hazardous area classification (Source: MSC.1/Circ.1557)

Reg. 45.11 Where the prescriptive requirements within SOLAS and related Codes (IBC and IGC Codes) and the standards published by the International Electrotechnical Commission (IEC), such as, but not limited to, IEC 60092-502, are not aligned, the prescriptive requirements in SOLAS and other relevant IMO instruments should take precedence and be applied. The differences between the above-mentioned documents are listed in appendix 3, as provided by IACS.

48 Protection against flooding (Source: MSC.1/Circ.1424)

Reg. 48.3 48.1 "Bilge injection system" is the same as "direct suction" referred to in SOLAS regulation II-1/35-1.3.7.1 and 3.7.2 and is understood to mean "emergency bilge suction", which is used to discharge overboard large quantities of seawater accumulated in engine room bilges using the main circulating pump or another suitable pump as permitted by SOLAS regulation II-1/35-1.3.7.2.

48.2 The requirements for the controls of the "valves serving a sea inlet, a discharge below the waterline or a bilge injection system" should not be applied to valves serving an emergency bilge system, provided:

- .1 the emergency bilge valve is normally maintained in a closed position;
 - .2 a non-return device is installed in the emergency bilge piping; and
- Note:** A normally closed non-return valve with positive means of closing is considered to satisfy both .1 and .2 above.
- .3 the emergency bilge suction piping is located inboard of a shell valve that is fitted with the control arrangements required by SOLAS regulation II-1/48.3.



Appendices to Unified Interpretations for Chapter II-1

Appendix 1 Examples of application for the most common systems

(Source: MSC.1/Circ.1572)

1 Example 1

- 1.1 Requirement according to SOLAS – Main and auxiliary engines and boiler(s) operating with heavy fuel oil (HFO) (one fuel ship)

HFO Serv. TK Capacity for at least 8 h Main Eng. + Aux. Eng. + Aux. Boiler	HFO Serv. TK Capacity for at least 8 h Main Eng. + Aux. Eng. + Aux. Boiler	MDO TK For initial cold starting or repair work Engines/Boiler
--	--	---

- 1.2 Equivalent arrangement

HFO Serv. TK Capacity for at least 8 h Main Eng. + Aux. Eng. + Aux. Boiler	MDO Serv. TK Capacity for at least 8 h Main Eng. + Aux. Eng. + Aux. Boiler
--	--

This interpretation only applies where main and auxiliary engines can operate with heavy fuel oil under all load conditions and, in the case of main engines, during manoeuvring.

For pilot burners of auxiliary boilers if provided, an additional MDO tank for 8 hours may be necessary.

2 Example 2

- 2.1 Requirement according to SOLAS – Main engine(s) and auxiliary boiler(s) operating with HFO and auxiliary engine operating with marine diesel oil (MDO)

HFO Serv. TK Capacity for at least 8 h Main Eng. + Aux. Boiler	HFO Serv. TK Capacity for at least 8 h Main Eng. + Aux. Boiler	MDO Serv. TK Capacity for at least 8 h Aux. Eng.	MDO Serv. TK Capacity for at least 8 h Aux. Eng.
---	---	---	---

- 2.2 Equivalent arrangement

HFO Serv. TK Capacity for at least 8 h Main Eng. + Aux. Boiler	MDO Serv. TK Capacity for at least the highest of: • 4 h Main Eng. + Aux. Eng. + Aux. Boiler or • 8 h Aux. Eng. + Aux. Boiler	MDO Serv. TK Capacity for at least the highest of: • 4 h Main Eng. + Aux. Eng. + Aux. Boiler or • 8 h Aux. Eng. + Aux. Boiler
---	---	---

The arrangements in paragraphs 1.2 and 2.2 apply, provided the propulsion and vital systems which use two types of fuel support rapid fuel changeover and are capable of operating in all normal operating conditions at sea with both types of fuel (MDO and HFO).

Appendix 2
Principle scheme for double non follow-up control and autopilot or other additional control

(Source: MSC.1/Circ.1398)

Reference should be made to the following examples 1, 2 and 3, which can be regarded as basic design.

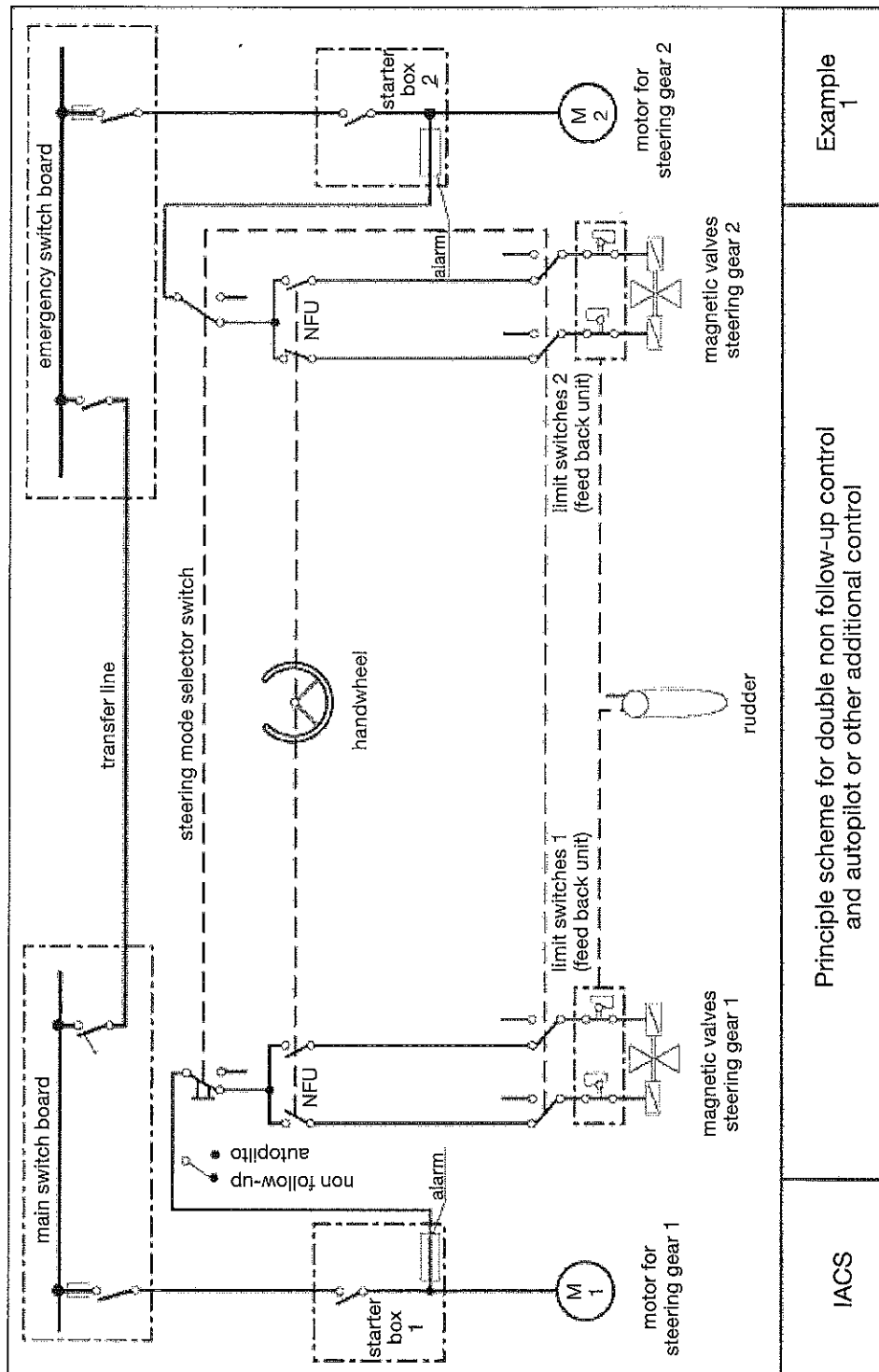

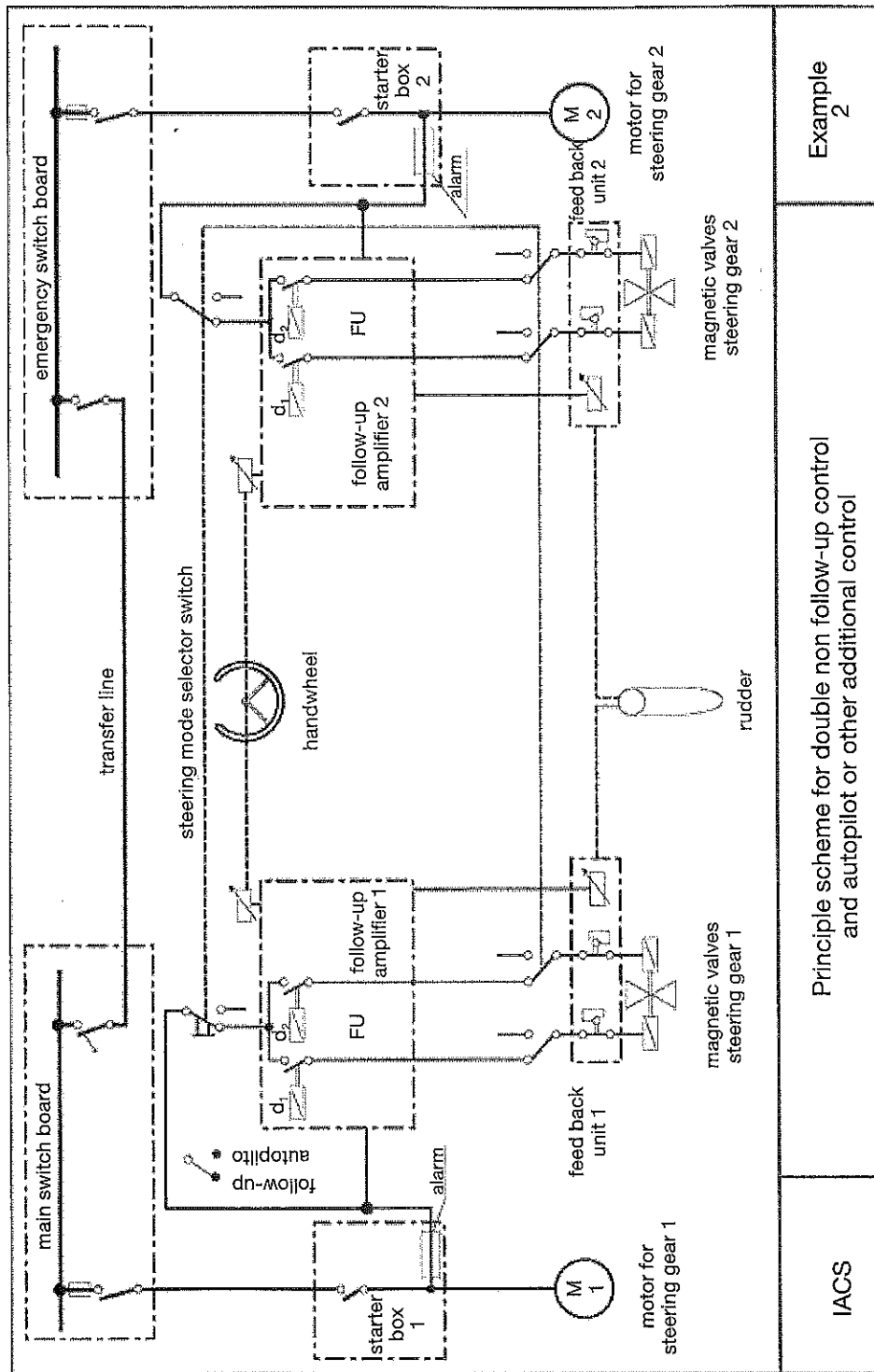

Example 2

Principle scheme for double non follow-up control and autopilot or other additional control

IACS

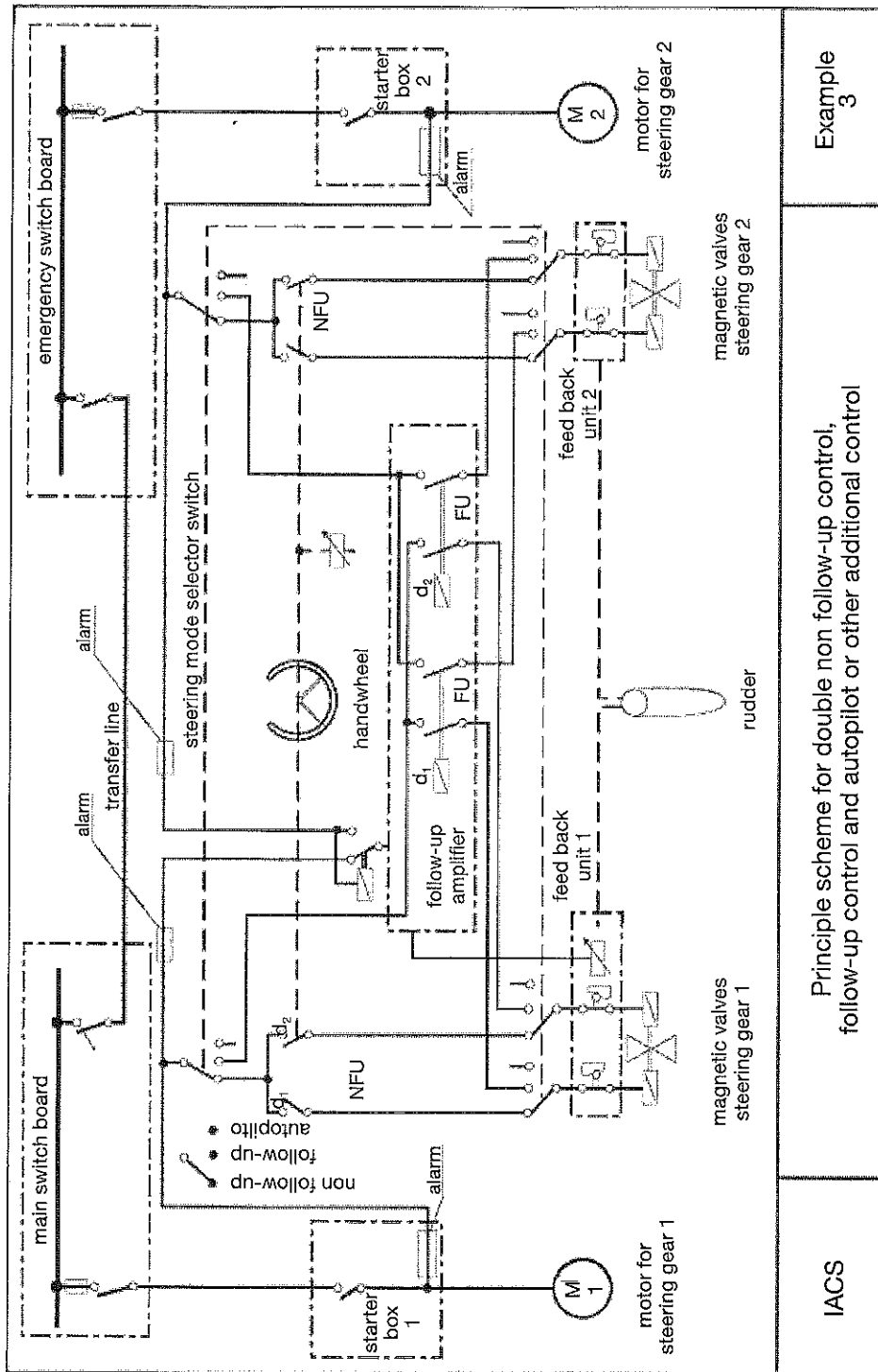

Example 3

Principle scheme for double non follow-up control, follow-up control and autopilot or other additional control

IACS

(Source: MSC.1/Circ.1557)

Appendix 3
Summary of discrepancies on the hazardous area classification issues
among the SOLAS Convention, the IBC and IGC Codes and standard IEC 60092-502

No.	Title	SOLAS	IBC	IGC	IEC 60092-502:1999
1	Hazardous area and classification on open deck from the cargo tank ventilation outlet for small flow by thermal variations	Within 5 m radius; SOLAS regulation II-2/11.6.2.2. Reference is made to U1 SC70 "Cargo tank vent systems and selection of electrical equipment".			Within 4.5 m radius; IEC 60092-502, 4.2.2.7 and 4.2.3.1. Zone 1: open areas on deck within a 3 m radius. Zone 2: additional 1.5 m beyond Zone 1; IEC 60092-502, 4.2.2.7 and 4.2.3.1. At least 6 m; IEC 60092-502, 4.2.2.7, 4.2.3.1 and 8.2.5.
2	The separation distance of the nearest air intakes for non-hazardous spaces from the tank ventilation outlet for small flow by thermal variations	At least 5 m; SOLAS regulation II-2/11.6.2.2.	At least 10 m; IBC Code, paragraph 8.3.4.2. At least 15 m; IBC Code, paragraph 15.12.1.3 (although toxicity not flammability).	At least 10 m; IGC Code, paragraph 8.2.10 and 2014 amended IGC Code, paragraph 8.2.11.2. Cargo tank PRV vent exits: at least equal to <i>B</i> or 25 m, whichever is less. For ships less than 90 m in length, smaller distances may be permitted; IGC Code, paragraph 8.2.10 and 2014 amended IGC Code, paragraph 8.2.11.1.	
3	The separation distance of the nearest air intakes for non-hazardous spaces from the tank vent outlets for cargo loading, discharging and ballasting	At least 10 m; SOLAS regulation II-2/4.5.3.4.1.3. At least 10 m; For tankers constructed on or after 1 January 2017 as per resolution MSC.392(95) SOLAS amendments of regulation II-2/11.6.2.2 referring back to regulation II-2/4.5.3.4.1.	At least 10 m; IBC Code, paragraph 12.1.5. At least 15 m; IBC Code, paragraph 15.12.1.3 (although toxicity not flammability).	At least 10 m; IGC Code, paragraph 12.1.6. Cargo tank PRV vent exits: at least equal to <i>B</i> or 25 m, whichever is less. For ships less than 90 m in length, smaller distances may be permitted; 2014 amended IGC Code, paragraph 8.2.11.1. All other vent outlets connected to the cargo containment system: at least 10 m; 2014 amended IGC Code, paragraph 8.2.11.2.	At least 11.5 m; IEC 60092-502, 4.2.2.8, 4.2.3.2 and 8.2.5.

Appendices to Unified Interpretations for Chapter II-1

No.	Title	SOLAS	IBC	IGC	IEC 60092-502:1999
4	The separation distance of the nearest air intakes for non-hazardous areas from the ventilation exhaust outlet for hazardous areas (i.e. cargo compressor room, cargo pump-room, etc.)	MSC.1/Circ.1321, part IV chapter 3, paragraph 1.2: the position of the cargo pump-room vent outlet should be arranged at a distance of at least 3 m measured horizontally from any ignition source and from the nearest opening to accommodation, service or machinery spaces.	At least 10 m; IBC Code, paragraph 12.1.5. Within the coaming required by 3.7.7 or within a 3 m radius beyond the coaming; IBC Code, paragraph 3.7.8. It should be noted that paragraph 3.7.8 only applies to stern or bow loading arrangements.	At least 10 m; IGC Code, paragraph 12.1.6. Ventilation ducts, air intakes and exhaust outlets serving artificial ventilation systems shall be positioned in accordance with recognized standards*, 2014 amended IGC Code, paragraph 12.1.5.	At least 6 m; IEC 60092-502, 4.2.2.7, 4.2.3.1 and 8.2.5.
5	Hazardous area and classification on open deck from the cargo shore connection or spillage coaming			Within 3 m radius; IGC Code, paragraph 3.8.6. It should be noted that paragraph 3.8.6 of the pre-2014 Code only applies to stern or bow loading arrangements. Within 3 m beyond the spillage coming up to a height of 2.4 m above the deck; 2014 amended IGC Code, paragraph 1.2.24.15.	Within 4.5 m radius; IEC 60092-502, 4.2.2.10 and 4.2.3.1. Zone 1: open areas on deck within a 3 m radius, up to a height of 2.4 m above the deck. Zone 2: additional 1.5 m beyond Zone 1; IEC 60092-502, 4.2.2.10 and 4.2.3.1.
6	Opening to main cargo control stations and service spaces not giving access to accommodations, control stations and similar spaces containing sources of ignition	Subject to Administration; SOLAS regulation II-2/4.5.2.2. Note: SOLAS regulation II-2/4.5.2.2 does not categorize the space as hazardous or non-hazardous.	IBC Code, paragraph 3.2.3.		The intent of a minimum distance of 1.5 m from the boundaries of any hazardous area is to be followed; IEC 60092-502, 8.2.5.
7	Openings to accommodation spaces, service spaces, control stations and machinery spaces facing the cargo area	Not less than 4% of L, but not less than 3 m from the end of the superstructure or deckhouse. (This distance need not exceed 5 m); SOLAS regulation II-2/4.5.2.	Not less than 4% of L, but not less than 3 m from the end of the superstructure or deckhouse. (This distance need not exceed 5 m); IBC Code, paragraph 3.2.3.	Not less than 4% of L, but not less than 3 m from the end of the superstructure or deckhouse. (This distance need not exceed 5 m); IGC Code, paragraph 3.2.4 and 2014 amended IGC Code, paragraph 3.2.4.1.	At least 1.5 m from the boundaries of any hazardous area; IEC 60092-502, 8.2.5.

* IEC 60092-502:1999.

No.	Title	SOLAS	IBC	IGC	IEC 60092-502:1999
8	Access doors to forecastle spaces containing source of ignition facing the cargo area	<p>Access doors to forecastle spaces containing source of ignition shall not face the cargo area; SOLAS regulation II-2/4.5.2.1.</p> <p>Access doors to forecastle spaces containing source of ignition shall not face the cargo area and are to be at not less than 3 m from the end of the superstructure or deckhouse. (This distance need not exceed 5 m); SOLAS regulation II-2/4.5.2.1.</p> <p>Reference is made to UI SC120 "Access to forecastle spaces on tankers; SOLAS regulations II-2/4.5.2.1 and 4.5.2.2, IBC Code paragraph 3.2.3 and IGC Code paragraph 3.2.4".</p>	<p>Access doors to forecastle spaces containing source of ignition shall not face the cargo area; IBC Code, paragraph 3.2.3.</p> <p>Reference is made to UI SC120 "Access to forecastle spaces on tankers; SOLAS regulations II-2/4.5.2.1 and 4.5.2.2, IBC Code paragraph 3.2.3 and IGC Code paragraph 3.2.4".</p>	<p>Access doors to forecastle spaces containing source of ignition shall not face the cargo area; IGC Code, paragraph 3.2.4.</p> <p>Accesses to forecastle spaces containing sources of ignition may be permitted through a single door facing the cargo area, provided the doors are located outside hazardous areas as defined in chapter 10; 2014 amended IGC Code, paragraph 3.2.4.4.</p> <p>Reference is made to UI SC120 "Access to forecastle spaces on tankers; SOLAS regulations II-2/4.5.2.1 and 4.5.2.2, IBC Code paragraph 3.2.3 and IGC Code paragraph 3.2.4".</p>	<p>The forecastle spaces installed the access doors facing the cargo area shall be designated as the hazardous area of Zone 2; IEC 60092-502, 4.2.</p> <p>See also IEC 60092-502, 4.2.3.6 as commented in item 18 below.</p>
9	Ventilation of cargo pump-rooms (cargo handling spaces on chemical and gas carriers)	<p>20 air changes/hour; SOLAS regulation II-2/4.5.4.1 and MSC.1/Circ.1321, part IV, chapter 3, paragraph 1.1.</p>	<p>30 air changes/hour; IBC Code, paragraph 12.1.3.</p> <p>45 air changes/hour; IBC Code, paragraph 15.17 (toxic).</p>	<p>30 air changes/hour; IGC Code, paragraph 12.1.2 and 2014 amended IGC Code, paragraph 12.1.3.</p>	<p>Spaces containing sources of release: 30 air changes/hour; IEC 60092-502, 8.1.3.</p> <p>Note: The IEC standard refer to spaces "containing sources of release", while the IBC and IGC Codes refer to spaces for "cargo handling operations".</p>
10	Ventilation of hazardous spaces not containing source of release		<p>20 air changes/hour; spaces normally entered IBC Code, paragraph 12.2.</p> <p>8 air changes/hour; spaces not normally entered; IBC Code, paragraph 12.3 (16 air changes/hour if portable).</p>		<p>Spaces not containing sources of release: 6 air changes/hour; IEC 60092-502, 8.1.3.</p>

No.	Title	SOLAS	IBC	IGC	IEC 60092-502:1999
11	Concentration of gas implying that space is non-hazardous (alarm limits)	10% LFL (lower flammable limit) for cargo pump-rooms in tankers; SOLAS regulation II-2/4.5.10.1.3. 30% LFL for all ballast tanks and void spaces of double-hull and double-bottom spaces adjacent to the cargo tanks in oil tankers of 20,000 tonnes deadweight and above; SOLAS regulation II-2/4.5.7.3 and the FSS Code, chapter 16, paragraph 2.2.3.3.	10% LFL for cargo pump-room; IBC Code, paragraph 11.1.1.7 (resolution MSC.219(82)), clarifying that SOLAS regulation II-2/4.5.10 applies, in which case "hydrocarbon gases" are replaced by "flammable vapours".	Alarms should be activated for flammable products when the vapour concentration reaches 30% of the lower flammable limit, for the spaces of paragraph 13.6.7 of the IGC Code; IGC Code, paragraph 13.6.10. 30% LFL for the spaces specified in paragraph 13.6.2 of the amended IGC Code; 2014 amended IGC Code, paragraph 13.6.15.	30% LFL; IEC 60092-502, 8.4.2. Note: The requirement of the standard applies to spaces protected by over-pressure.
12	Fan monitoring (air lock)			Monitoring of current or power in the electrical supply is accepted; IGC Code, paragraph 3.6.4 (MSC/Circ.406). Where spaces are protected by pressurization, the ventilation shall be designed and installed in accordance with recognized standards*; 2014 amended IGC Code, paragraph 3.6.2.	Motor running or rotating fan monitoring device is not accepted; IEC 60092-502, 8.4.3.
13	Tanks for heated cargo	Tanker requirements apply to tankers carrying cargo with FP below 60°C; SOLAS regulation II-2/1.6.1. For petroleum cargoes with FP of 60°C and above only deck foam requirements apply; SOLAS regulation II-2/1.6.4. Hazardous zone classification and electrical installation shall be complied with; IEC 60092-502:1999; SOLAS regulation II-1/45.11.	Follows SOLAS principle related to flashpoint. However, the IBC Code considers non-flammable (NF) products and products with a flashpoint of 60°C and above in a different way (paragraphs 11.1.2 and 11.1.3); In the case of a heated cargo, carriage conditions might need to be established and the requirements for cargoes having a flashpoint not exceeding 60°C applied; IBC Code, regulation 10.1.6.		When carrying cargoes heated to temperature within 15°C of their flash point, hazardous zone classification for tankers carrying cargoes with FP not exceeding 60°C applies; IEC 60092-502, 4.3.2 referring back to 4.2.

* IEC 60092-502:1999. As per the Note to 8.4.3 of the standard, a fan motor or a fan rotation monitoring device will not satisfy this requirement.

No.	Title	SOLAS	IBC	IGC	IEC 60092-502:1999
14	Classification of cargo pump-room	Hazardous zone classification and electrical installation shall be compiled with: IEC 60092-502:1999; SOLAS regulation II-1/45.11.		IGC Code, paragraph 1.3.17.7; 2014 amended IGC Code, paragraph 1.2.24.6.	IEC 60092-502, 4.1.4.1 Table 1 and 4.2.2.4 may indicate that cargo pump-rooms are Zone 1. However, as ventilation is only running during cargo handling, the requirements may be interpreted that it is Zone 0 (flag Administration position may be required).
15	Discontinuation of ventilation for long periods		Spare parts shall be carried for each type of ventilation fan required on board; IBC Code, paragraph 12.1.9.	Spare parts shall be carried for each type of ventilation fan required on board; IGC Code, paragraph 12.1.10. Where fans are required, full required ventilation capacity for each space shall be available after failure of any single fan, or spare parts shall be provided comprising a motor, starter spares and complete rotating element, including bearings of each type; 2014 amended IGC Code, paragraph 12.1.8.	IEC 60092-502, 8.3.1 includes an assumption that ventilation shall not be discontinued for long periods.
16	Gas carrier ballast tanks			Ballast tanks may be connected to pumps in machinery spaces; IGC Code, paragraph 3.7.4; 2014 amended IGC Code, paragraph 3.7.5.	Ballast tanks on gas carriers, separated from a hold space, where cargo is carried in a cargo tank requiring a secondary barrier, by a single gastight boundary, are hazardous areas Zone 1.
17	Gas carrier hold space				Hold spaces of gas carriers (except those with C-tanks), where a secondary barrier is required, are considered hazardous areas Zone 0; IEC 60092-502, 4.4.1 and annex D.

Appendices to Unified Interpretations for Chapter II-1

No.	Title	SOLAS	IBC	IGC	IEC 60092-502:1999
18	Access to forward spaces below level of main deck	Access openings to service spaces, control stations and machinery spaces are not to face the cargo area; SOLAS regulation II-2/4.5.2. Reference is made to UI SC120 "Access to forecastle spaces on tankers; SOLAS regulations II-2/4.5.2.1 and 4.5.2.2, IBC Code, paragraph 3.2.3 and IGC Code, paragraph 3.2.4".	Reference is made to UI SC120 "Access to forecastle spaces on tankers; SOLAS regulations II-2/4.5.2.1 and 4.5.2.2, IBC Code paragraph 3.2.3 and IGC Code paragraph 3.2.4".	Reference is made to UI SC120 "Access to forecastle spaces on tankers; SOLAS regulations II-2/4.5.2.1 and 4.5.2.2, IBC Code paragraph 3.2.3 and IGC Code paragraph 3.2.4".	It is implied that as long as the sill height is above 0.5 m then it is exempted from SOLAS and can face the cargo area; IEC 60092-502, 4.2.3.6.
19	Hazardous zone classification on main deck of tankers with deck girders				The entire deck area up to 2.4 m is considered as Zone 1 if deck girders are provided as they are considered to restrict natural ventilation; IEC 60092-502, 4.2.2.11.
20	Hazardous zone in way of P/V-breaker	SOLAS regulation II-2/11.6.2.2: at least 5 m. SOLAS amended regulation II-2/11.6.2.2 as per resolution MSC.392(95): at least 10 m for tankers constructed on or after 1 January 2017.			10 m from a cargo gas outlet intended for the passage of large volumes of gas or vapour mixture during cargo loading; IEC 60092-502, 4.2.2.8 & 4.2.3.2 based on UI SC140, otherwise 4.5 m from a P/V breaker which does not release large volumes of gas or vapour locally; IEC 60092-502, 4.2.2.7 & 4.2.3.1.
21	Location of fan motors for cargo pump-room and compressor room		To be located outside ducts; IBC Code, paragraph 12.1.8.	To be located outside ducts; IGC Code, paragraph 12.1.9. 2014 amended IGC Code, paragraph 12.1.7.	IEC 60092-502; follows zone classification, i.e. if Zone 0, outside ventilation duct (based on 6.5.2). If Zone 1, inside OK, provided certified for Zone 1.

No.	Title	SOLAS	IBC	IGC	IEC 60092-502:1999
22	Openings to accommodation spaces, service spaces, control stations and machinery spaces facing the cargo area	Shall not face the cargo area. Can be located at the transverse bulkhead not facing the cargo area, at a distance of at least 4% of the length of the ship but not less than 3 m from the end of the superstructure or deck-house facing the cargo area. This distance need not exceed 5 m; SOLAS regulation II-2/4.5.2.1. Refer to SOLAS regulation II-2/4.5.2.2 for permitted access doors to main cargo control stations and service spaces and to wheelhouse doors and windows.	Shall not face the cargo area. They shall be located on the end bulkhead not facing the cargo area and/or on the outboard side of the superstructure or deck-house at a distance of at least 4% of the length (L) of the ship but not less than 3 m from the end of the superstructure or deck-house facing the cargo area. This distance, however, need not exceed 5 m. Refer to same paragraph for permitted access doors to spaces not having access to accommodation and service spaces and control stations, and wheelhouse doors and windows; IBC Code, paragraph 3.2.3.	Should not face the cargo area. They should be located on the end bulkhead not facing the cargo area or on the outboard side of the superstructure or deck-house or on both at a distance of at least 4% of the length (L) of the ship but not less than 3 m from the end of the superstructure or deck-house facing the cargo area. This distance, however, need not exceed 5 m. Refer to same paragraph for wheelhouse doors and windows; IGC Code, paragraph 3.2.4. 2014 amended IGC Code: paragraphs 3.2.4.1 and 3.2.4.2 (same requirements, except the amended Code uses "shall" instead of "should").	Access doors or other openings shall not be intended to be considered as non-hazardous and a hazardous area, or between a space intended to be considered as Zone 2 and a Zone 1 space except where required for operational reasons. Where access doors or other openings are provided for operational reasons, 4.1.5.2, 4.1.5.3, 4.1.5.4 or 4.1.5.5 apply; IEC 60092-502, 4.1.5. Where a space has an opening into an adjacent, more hazardous space or area, it may be made into a less hazardous space or non-hazardous space by pressurisation designed and operated in accordance with the requirements given in 8.2 and 8.4; IEC 60092-502, 8.1.4. Note: SOLAS and Codes refer to permitted openings of spaces, while the IEC standard defines hazardous areas. Protection by over-pressure where a non-hazardous space has openings into a hazardous space; IEC 60092-502, 8.4. IEC 60092-502, 4.1.5.3.
23	Protection by over-pressure			IGC Code, paragraph 12.1.4. 2014 amended IGC Code, paragraph 12.1.4.	
24	Air locks			IGC Code, paragraph 3.6. 2014 amended IGC Code, paragraph 3.6.	

Appendices to Unified Interpretations for Chapter II-1

No.	Title	SOLAS	IBC	IGC	IEC 60092-502:1999
25	Earthed distribution systems and hull return systems	<p>Earthed distribution systems shall not be used in a tanker. The Administration may exceptionally permit in a tanker the earthing of the neutral for alternating current power networks of 3,000 V (line to line) and over, provided that any possible resulting current does not flow directly through any of the dangerous spaces; SOLAS regulation II-1/45.4.1.</p> <p>The hull return system of distribution shall not be used for any purpose in a tanker; SOLAS regulation II-1/45.3.1.</p> <p>The above regulation does not preclude under conditions approved by the Administration the use of:</p> <ul style="list-style-type: none"> - impressed current cathodic protective systems; - limited and locally earthed systems; or - insulation level monitoring devices provided the circulation current does not exceed 30 mA under the most unfavourable conditions. <p>SOLAS regulation II-1/45.3.2.</p>	IBC Code, chapter 10: IEC 60092-502:1999.	IGC Code, paragraph 1.3.17.8, 2014 amended IGC Code, paragraph 1.2.24.9.	<p>Distribution systems: Distribution systems shall comply with the provisions of IEC 60092-201.</p> <p>Both insulated and earthed distribution systems are permitted; systems with a hull or structure return, other than those noted under 5.2.2, are not permitted; IEC 60092-502, 5.2.1.</p> <p>The following systems are permitted to be of hull or structure return type:</p> <ul style="list-style-type: none"> - limited and locally earthed systems outside any hazardous area; - intrinsically-safe systems; - impressed current cathodic protective systems; <p>IEC 60092-502, 5.2.2.</p> <p>The neutral and any conductor required for protection against electric shock shall not be connected together or combined in a single conductor in a hazardous area; IEC 60092-502, 5.2.3.</p>
26	Hazardous zone classification on main deck of tankers	<p>Hazardous zone classification and electrical installation shall be complied with IEC 60092-502:1999; SOLAS regulation II-1/45.11.</p>	IBC Code, chapter 10: IEC 60092-502:1999.	IGC Code, paragraph 1.3.17.8, 2014 amended IGC Code, paragraph 1.2.24.9.	<p>The cargo tanks, including all ballast tanks with cargo tank area; IEC 60092-502, 4.2.2.11 and 4.2.3.5 (areas on open deck over cargo tanks as per the above IEC paragraphs do not coincide with the definition of the cargo area in SOLAS or the Codes).</p>

Chapter II-2

Construction – Fire protection,
fire detection and fire extinction

Chapter II-2

Construction – Fire protection, fire detection and fire extinction

II-2

Part A	General	
Regulation 1	Application	163
Regulation 2	Fire safety objectives and functional requirements	166
Regulation 3	Definitions	167
Part B	Prevention of fire and explosion	
Regulation 4	Probability of ignition	173
Regulation 5	Fire growth potential	184
Regulation 6	Smoke generation potential and toxicity	187
Part C	Suppression of fire	
Regulation 7	Detection and alarm	188
Regulation 8	Control of smoke spread	191
Regulation 9	Containment of fire	192
Regulation 10	Fire fighting	220
Regulation 11	Structural integrity	234
Part D	Escape	
Regulation 12	Notification of crew and passengers	237
Regulation 13	Means of escape	237
Part E	Operational requirements	
Regulation 14	Operational readiness and maintenance	246
Regulation 15	Instructions, on-board training and drills	247
Regulation 16	Operations	249
Part F	Alternative design and arrangements	
Regulation 17	Alternative design and arrangements	252
Part G	Special requirements	
Regulation 18	Helicopter facilities	254
Regulation 19	Carriage of dangerous goods	257
Regulation 20	Protection of vehicle, special category and ro-ro spaces	264



Regulation 20-1	Requirements for vehicle carriers carrying motor vehicles with compressed hydrogen or natural gas in their tanks for their own propulsion as cargo	269
Regulation 21	Casualty threshold, safe return to port and safe areas	270
Regulation 22	Design criteria for systems to remain operational after a fire casualty	272
Regulation 23	Safety centre on passenger ships	273
Unified Interpretations for Chapter II-2		275

Part A

General

Regulation 1*

Application

1 Application

1.1 Unless expressly provided otherwise, this chapter shall apply to ships constructed on or after 1 July 2012.

1.2 For the purpose of this chapter:

- .1 the expression *ships constructed* means ships the keels of which are laid or which are at a similar stage of construction;
- .2 the expression *all ships* means ships, irrespective of type, constructed before, on or after 1 July 2012; and
- .3 a cargo ship, whenever built, which is converted to a passenger ship shall be treated as a passenger ship constructed on the date on which such a conversion commences.

1.3 For the purpose of this chapter, the expression *a similar stage of construction* means the stage at which:

- .1 construction identifiable with a specific ship begins; and
- .2 assembly of that ship has commenced comprising at least 50 tonnes or 1% of the estimated mass of all structural material, whichever is less.

2 Applicable requirements to existing ships

2.1 Unless expressly provided otherwise, for ships constructed before 1 July 2012, the Administration shall ensure that the requirements which are applicable under chapter II-2 of the International Convention for the Safety of Life at Sea, 1974, as amended by resolutions MSC.1(XLV), MSC.6(48), MSC.13(57), MSC.22(59), MSC.24(60), MSC.27(61), MSC.31(63), MSC.57(67), MSC.99(73), MSC.134(76), MSC.194(80), MSC.201(81), MSC.216(82), MSC.256(84), MSC.269(85) and MSC.291(87) are complied with.

2.2 Ships constructed before 1 July 2002 shall also comply with:

- .1 paragraphs 3, 6.5 and 6.7 as appropriate;
- .2 regulations 13.3.4.2 to 13.3.4.5, 13.4.3 and part E, except regulations 16.3.2.2 and 16.3.2.3 thereof, as appropriate, not later than the date of the first survey[†] after 1 July 2002;
- .3 regulations 10.4.1.3 and 10.6.4 for new installations only;
- .4 regulation 10.5.6 not later than 1 October 2005 for passenger ships of 2,000 gross tonnage and above;

* The application date of 1 July 2012 was introduced by resolution MSC.308(88). However, this resolution amended, under chapter II-2, regulations II-2/3.23 (definition of "Fire Test Procedures Code") and II-2/7.4.1 (new subparagraph .3) only, and all other regulations with the original application date of 1 July 2002 were not amended.

[†] Refer to the *Unified interpretation of the term "first survey" referred to in SOLAS regulations (MSC.1/Circ.1290)*.

- .5 regulations 5.3.1.3.2 and 5.3.4 to passenger ships not later than the date of the first survey after 1 July 2008; and
- .6 regulation 4.5.7.1.

2.3 Ships constructed on or after 1 July 2002 and before 1 July 2010 shall comply with paragraphs 7.1.1, 7.4.4.2, 7.4.4.3 and 7.5.2.1.2 of regulation 9, as adopted by resolution MSC.99(73).

2.4 The following ships, with cargo spaces intended for the carriage of packaged dangerous goods, shall comply with regulation 19.3, except when carrying dangerous goods specified as classes 6.2 and 7 and dangerous goods in limited quantities* and excepted quantities† in accordance with tables 19.1 and 19.3, not later than the date of the first renewal survey on or after 1 January 2011:

- .1 cargo ships of 500 gross tonnage and upwards and passenger ships constructed on or after 1 September 1984 but before 1 January 2011; and
- .2 cargo ships of less than 500 gross tonnage constructed on or after 1 February 1992 but before 1 January 2011,

and notwithstanding these provisions:

- .3 cargo ships of 500 gross tonnage and upwards and passenger ships constructed on or after 1 September 1984 but before 1 July 1986 need not comply with regulation 19.3.3 provided that they comply with regulation 54.2.3 as adopted by resolution MSC.1(XLV);
- .4 cargo ships of 500 gross tonnage and upwards and passenger ships constructed on or after 1 July 1986 but before 1 February 1992 need not comply with regulation 19.3.3 provided that they comply with regulation 54.2.3 as adopted by resolution MSC.6(48);
- .5 cargo ships of 500 gross tonnage and upwards and passenger ships constructed on or after 1 September 1984 but before 1 July 1998 need not comply with regulations 19.3.10.1 and 19.3.10.2;
- .6 cargo ships of less than 500 gross tonnage constructed on or after 1 February 1992 but before 1 July 1998 need not comply with regulations 19.3.10.1 and 19.3.10.2;
- .7 cargo ships of 500 gross tonnage and upwards and passenger ships constructed on or after 1 February 1992 but before 1 July 2002 need not comply with regulation 19.3.3 provided that they comply with regulation 54.2.3 as adopted by resolution MSC.13(57); and
- .8 cargo ships of 500 gross tonnage and upwards and passenger ships constructed on or after 1 September 1984 but before 1 July 2002 need not comply with regulations 19.3.1, 19.3.5, 19.3.6, 19.3.9, provided that they comply with regulations 54.2.1, 54.2.5, 54.2.6, 54.2.9 as adopted by resolution MSC.1(XLV).

2.5 Ships constructed before 1 July 2012 shall also comply with regulation 10.10.1.2, as adopted by resolution MSC.338(91).

2.6 Vehicle carriers constructed before 1 January 2016, including those constructed before 1 July 2012, shall comply with paragraph 2.2 of regulation 20-1, as adopted by resolution MSC.365(93).

2.7 Tankers constructed before 1 January 2016, including those constructed before 1 July 2012, shall comply with regulation 16.3.3 except 16.3.3.3.

2.8 Regulations 4.5.5.1.1 and 4.5.5.1.3 apply to ships constructed on or after 1 July 2002 but before 1 January 2016, and regulation 4.5.5.2.1 applies to all ships constructed before 1 January 2016.

2.9 Regulation 10.5.1.2.2, as amended by resolution MSC.409(97), applies to ships constructed before 1 January 2020, including those constructed before 1 July 2012.

* Refer to chapter 3.4 of the IMDG Code.

† Refer to chapter 3.5 of the IMDG Code.

3 Repairs, alterations, modifications and outfitting

SEE INTERPRETATION 1

3.1 All ships which undergo repairs, alterations, modifications and outfitting related thereto shall continue to comply with at least the requirements previously applicable to these ships. Such ships, if constructed before 1 July 2012, shall, as a rule, comply with the requirements for ships constructed on or after that date to at least the same extent as they did before undergoing such repairs, alterations, modifications or outfitting.

3.2 Repairs, alterations and modifications which substantially alter the dimensions of a ship or the passenger accommodation spaces, or substantially increase a ship's service life and outfitting related thereto, shall meet the requirements for ships constructed on or after 1 July 2012 in so far as the Administration deems reasonable and practicable.

4 Exemptions

4.1 The Administration may, if it considers that the sheltered nature and conditions of the voyage are such as to render the application of any specific requirements of this chapter unreasonable or unnecessary, exempt* from those requirements individual ships or classes of ships entitled to fly the flag of its State, provided that such ships, in the course of their voyage, do not sail at distances of more than 20 miles from the nearest land.

4.2 In the case of passenger ships which are employed in special trades for the carriage of large numbers of special trade passengers, such as the pilgrim trade, the Administration, if satisfied that it is impracticable to enforce compliance with the requirements of this chapter, may exempt such ships from those requirements, provided that they comply fully with the provisions of:

- .1 the rules annexed to the Special Trade Passenger Ships Agreement, 1971; and
- .2 the rules annexed to the Protocol on Space Requirements for Special Trade Passenger Ships, 1973.

5 Applicable requirements depending on ship type

Unless expressly provided otherwise:

- .1 requirements not referring to a specific ship type shall apply to ships of all types; and
- .2 requirements referring to "tankers" shall apply to tankers subject to the requirements specified in paragraph 6 below.

6 Application of requirements for tankers

6.1 Requirements for tankers in this chapter shall apply to tankers carrying crude oil or petroleum products having a flashpoint not exceeding 60°C (closed-cup test), as determined by an approved flashpoint apparatus, and a Reid vapour pressure which is below the atmospheric pressure or other liquid products having a similar fire hazard.

6.2 Where liquid cargoes other than those referred to in paragraph 6.1 or liquefied gases which introduce additional fire hazards are intended to be carried, additional safety measures shall be required, having due regard to the provisions of the International Bulk Chemical Code, as defined in regulation VII/8.1, the Bulk Chemical Code, the International Gas Carrier Code, as defined in regulation VII/11.1, and the Gas Carrier Code, as appropriate.

6.2.1 A liquid cargo with a flashpoint of less than 60°C for which a regular foam fire-fighting system complying with the Fire Safety Systems Code is not effective, is considered to be a cargo introducing additional fire hazards in this context. The following additional measures are required:

- .1 the foam shall be of alcohol-resistant type;

* Refer to *Port State concurrence with SOLAS exemptions* (MSC/Circ.606).

- II-2
- .2 the type of foam concentrates for use in chemical tankers shall be to the satisfaction of the Administration, taking into account the guidelines developed by the Organization;* and
 - .3 the capacity and application rates of the foam extinguishing system shall comply with chapter 11 of the International Bulk Chemical Code, except that lower application rates may be accepted based on performance tests. For tankers fitted with inert gas systems, a quantity of foam concentrate sufficient for 20 min of foam generation may be accepted.†

6.2.2 For the purpose of this regulation, a liquid cargo with a vapour pressure greater than 1.013 bar absolute at 37.8°C is considered to be a cargo introducing additional fire hazards. Ships carrying such substances shall comply with paragraph 15.14 of the International Bulk Chemical Code. When ships operate in restricted areas and at restricted times, the Administration concerned may agree to waive the requirements for refrigeration systems in accordance with paragraph 15.14.3 of the International Bulk Chemical Code.

6.3 Liquid cargoes with a flashpoint exceeding 60°C other than oil products or liquid cargoes subject to the requirements of the International Bulk Chemical Code are considered to constitute a low fire risk, not requiring the protection of a fixed foam extinguishing system.

6.4 Tankers carrying petroleum products with a flashpoint exceeding 60°C (closed-cup test), as determined by an approved flashpoint apparatus, shall comply with the requirements provided in regulations 10.2.1.4.4 and 10.10.2.3 and the requirements for cargo ships other than tankers, except that, in lieu of the fixed fire-extinguishing system required in regulation 10.7, they shall be fitted with a fixed deck foam system which shall comply with the provisions of the Fire Safety Systems Code.

6.5 Combination carriers constructed before, on or after 1 July 2002 shall not carry cargoes other than oil unless all cargo spaces are empty of oil and gas-freed or unless the arrangements provided in each case have been approved by the Administration taking into account the guidelines developed by the Organization.‡

6.6 Chemical tankers and gas carriers shall comply with the requirements for tankers, except where alternative and supplementary arrangements are provided to the satisfaction of the Administration, having due regard to the provisions of the International Bulk Chemical Code and the International Gas Carrier Code, as appropriate.

6.7 The requirements of regulations 4.5.10.1.1 and 4.5.10.1.4 and a system for continuous monitoring of the concentration of hydrocarbon gases shall be fitted on all tankers constructed before 1 July 2002 by the date of the first scheduled dry-docking after 1 July 2002, but not later than 1 July 2005. Sampling points or detector heads shall be located in suitable positions in order that potentially dangerous leakages are readily detected. When the hydrocarbon gas concentration reaches a pre-set level which shall not be higher than 10% of the lower flammable limit, a continuous audible and visual alarm signal shall be automatically effected in the pump-room and cargo control room to alert personnel to the potential hazard. However, existing monitoring systems already fitted having a pre-set level not greater than 30% of the lower flammable limit may be accepted.

Regulation 2

Fire safety objectives and functional requirements

1 Fire safety objectives

1.1 The fire safety objectives of this chapter are to:

- .1 prevent the occurrence of fire and explosion;
- .2 reduce the risk to life caused by fire;
- .3 reduce the risk of damage caused by fire to the ship, its cargo and the environment;
- .4 contain, control and suppress fire and explosion in the compartment of origin; and
- .5 provide adequate and readily accessible means of escape for passengers and crew.

* Refer to *Revised guidelines for the performance and testing criteria, and surveys of foam concentrates for fixed fire-extinguishing systems* (MSC.1/Circ.1312 and Corr.1).

† Refer to *Information on flashpoint and recommended fire-fighting media for chemicals to which neither the IBC nor BCH Codes apply* (MSC/Circ.553).

‡ Refer to *Guidelines for inert gas systems* (MSC/Circ.353, as amended by MSC/Circ.387).

2 Functional requirements

2.1 In order to achieve the fire safety objectives set out in paragraph 1, the following functional requirements are embodied in the regulations of this chapter as appropriate:

- .1 division of the ship into main vertical and horizontal zones by thermal and structural boundaries;
- .2 separation of accommodation spaces from the remainder of the ship by thermal and structural boundaries;
- .3 restricted use of combustible materials;
- .4 detection of any fire in the zone of origin;
- .5 containment and extinction of any fire in the space of origin;
- .6 protection of means of escape and access for fire fighting;
- .7 ready availability of fire-extinguishing appliances; and
- .8 minimization of possibility of ignition of flammable cargo vapour.

3 Achievement of the fire safety objectives

The fire safety objectives set out in paragraph 1 shall be achieved by ensuring compliance with the prescriptive requirements specified in parts B, C, D, E or G, or by alternative design and arrangements which comply with part F. A ship shall be considered to meet the functional requirements set out in paragraph 2 and to achieve the fire safety objectives set out in paragraph 1 when either:

- .1 the ship's design and arrangements, as a whole, comply with the relevant prescriptive requirements in parts B, C, D, E or G;
- .2 the ship's design and arrangements, as a whole, have been reviewed and approved in accordance with part F; or
- .3 part(s) of the ship's design and arrangements have been reviewed and approved in accordance with part F and the remaining parts of the ship comply with the relevant prescriptive requirements in parts B, C, D, E or G.

Regulation 3

Definitions

For the purpose of this chapter, unless expressly provided otherwise, the following definitions shall apply:

1 *Accommodation spaces* are those spaces used for public spaces, corridors, lavatories, cabins, offices, hospitals, cinemas, game and hobby rooms, barber shops, pantries containing no cooking appliances and similar spaces.

2 *"A" class divisions* are those divisions formed by bulkheads and decks which comply with the following criteria:

- .1 they are constructed of steel or other equivalent material;
- .2 they are suitably stiffened;
- .3 they are insulated with approved non-combustible materials such that the average temperature of the unexposed side will not rise more than 140°C above the original temperature, nor will the temperature, at any one point, including any joint, rise more than 180°C above the original temperature, within the time listed below:

class "A-60"	60 min
class "A-30"	30 min
class "A-15"	15 min
class "A-0"	0 min

SEE INTERPRETATION 2

- .4 they are so constructed as to be capable of preventing the passage of smoke and flame to the end of the one-hour standard fire test; and
- .5 the Administration required a test of a prototype bulkhead or deck in accordance with the Fire Test Procedures Code to ensure that it meets the above requirements for integrity and temperature rise.

3 *Atriums* are public spaces within a single main vertical zone spanning three or more open decks.

4 "*B*" class divisions are those divisions formed by bulkheads, decks, ceilings or linings which comply with the following criteria:

- .1 they are constructed of approved non-combustible materials and all materials used in the construction and erection of "*B*" class divisions are non-combustible, with the exception that combustible veneers may be permitted provided they meet other appropriate requirements of this chapter;
- .2 they have an insulation value such that the average temperature of the unexposed side will not rise more than 140°C above the original temperature, nor will the temperature at any one point, including any joint, rise more than 225°C above the original temperature, within the time listed below:

class "B-15"	15 min
class "B-0"	0 min

- .3 they are so constructed as to be capable of preventing the passage of flame to the end of the first half hour of the standard fire test; and
- .4 the Administration required a test of a prototype division in accordance with the Fire Test Procedures Code to ensure that it meets the above requirements for integrity and temperature rise.

5 *Bulkhead deck* is the uppermost deck up to which the transverse watertight bulkheads are carried.

6 *Cargo area* is that part of the ship that contains cargo holds, cargo tanks, slop tanks and cargo pump-rooms including pump-rooms, cofferdams, ballast and void spaces adjacent to cargo tanks and also deck areas throughout the entire length and breadth of the part of the ship over the aforementioned spaces.

7 *Cargo ship* is a ship as defined in regulation I/2(g).

8 *Cargo spaces* are spaces used for cargo, cargo oil tanks, tanks for other liquid cargo and trunks to such spaces.

9 *Central control station* is a control station in which the following control and indicator functions are centralized:

- .1 fixed fire detection and fire alarm systems;
- .2 automatic sprinkler, fire detection and fire alarm systems;
- .3 fire door indicator panels;
- .4 fire door closure;
- .5 watertight door indicator panels;
- .6 watertight door closures;
- .7 ventilation fans;
- .8 general/fire alarms;
- .9 communication systems including telephones; and
- .10 microphones to public address systems.

10 "*C*" class divisions are divisions constructed of approved non-combustible materials. They need meet neither requirements relative to the passage of smoke and flame nor limitations relative to the temperature rise. Combustible veneers are permitted provided they meet the requirements of this chapter.

- 11 *Chemical tanker* is a cargo ship constructed or adapted and used for the carriage in bulk of any liquid product of a flammable nature listed in chapter 17 of the International Bulk Chemical Code, as defined in regulation VII/8.1.
- 12 *Closed ro-ro spaces* are ro-ro spaces which are neither open ro-ro spaces nor weather decks.
- 13 *Closed vehicle spaces* are vehicle spaces which are neither open vehicle spaces nor weather decks.
- 14 *Combination carrier* is a cargo ship designed to carry both oil and solid cargoes in bulk.
- 15 *Combustible material* is any material other than a non-combustible material.
- 16 *Continuous "B" class ceilings or linings* are those "B" class ceilings or linings which terminate at an "A" or "B" class division.
- 17 *Continuously manned central control station* is a central control station which is continuously manned by a responsible member of the crew.
- 18 *Control stations* are those spaces in which the ship's radio or main navigating equipment or the emergency source of power is located or where the fire recording or fire control equipment is centralized. Spaces where the fire recording or fire control equipment is centralized are also considered to be a fire control station.
- 19 *Crude oil* is any oil occurring naturally in the earth, whether or not treated to render it suitable for transportation, and includes crude oil where certain distillate fractions may have been removed from or added to.
- 20 *Dangerous goods* are those goods referred to in the IMDG Code, as defined in regulation VII/1.1.
- 21 *Deadweight* is the difference in tonnes between the displacement of a ship in water of a specific gravity of 1.025 at the load waterline corresponding to the assigned summer freeboard and the lightweight of the ship.

SEE INTERPRETATION 3

- 22 *Fire Safety Systems Code* means the International Code for Fire Safety Systems as adopted by the Maritime Safety Committee of the Organization by resolution MSC.98(73), as may be amended by the Organization, provided that such amendments are adopted, brought into force and take effect in accordance with the provisions of article VIII of the present Convention concerning the amendment procedures applicable to the annex other than chapter I thereof.
- 23 *Fire Test Procedures Code* means the International Code for Application of Fire Test Procedures, 2010 (2010 FTP Code) as adopted by the Maritime Safety Committee of the Organization by resolution MSC.307(88), as may be amended by the Organization, provided that such amendments are adopted, brought into force and take effect in accordance with the provisions of article VIII of the present Convention concerning the amendment procedures applicable to the annex other than chapter I.*
- 24 *Flashpoint* is the temperature in degrees Celsius (closed-cup test) at which a product will give off enough flammable vapour to be ignited, as determined by an approved flashpoint apparatus.
- 25 *Gas carrier* is a cargo ship constructed or adapted and used for the carriage in bulk of any liquefied gas or other products of a flammable nature listed in chapter 19 of the International Gas Carrier Code, as defined in regulation VII/11.1.
- 26 *Helideck* is a purpose-built helicopter landing area located on a ship including all structure, fire-fighting appliances and other equipment necessary for the safe operation of helicopters.
- 27 *Helicopter facility* is a helideck including any refuelling and hangar facilities.

* The list of laboratories recognized by Administrations which are able to conduct fire tests in accordance with the provisions of the 2010 FTP Code are circulated through the Global Integrated Shipping Information System (GISIS) (resolution A.1074(28)) under the module called "Test Laboratories and Halon Facilities".

28 *Lightweight* is the displacement of a ship in tonnes without cargo, fuel, lubricating oil, ballast water, fresh water and feedwater in tanks, consumable stores, and passengers and crew and their effects.

29 *Low flame-spread* means that the surface thus described will adequately restrict the spread of flame, this being determined in accordance with the Fire Test Procedures Code.

30 *Machinery spaces* are machinery spaces of category A and other spaces containing propulsion machinery, boilers, oil fuel units, steam and internal combustion engines, generators and major electrical machinery, oil filling stations, refrigerating, stabilizing, ventilation and air conditioning machinery, and similar spaces, and trunks to such spaces.

31 *Machinery spaces of category A* are those spaces and trunks to such spaces which contain either:

- .1 internal combustion machinery used for main propulsion;
- .2 internal combustion machinery used for purposes other than main propulsion where such machinery has in the aggregate a total power output of not less than 375 kW; or
- .3 any oil-fired boiler or oil fuel unit, or any oil-fired equipment other than boilers, such as inert gas generators, incinerators, etc.

32 *Main vertical zones* are those sections into which the hull, superstructure and deckhouses are divided by "A" class divisions, the mean length and width of which on any deck does not in general exceed 40 m.

33 *Non-combustible material* is a material which neither burns nor gives off flammable vapours in sufficient quantity for self-ignition when heated to approximately 750°C, this being determined in accordance with the Fire Test Procedures Code.

34 *Oil fuel unit* is the equipment used for the preparation of oil fuel for delivery to an oil-fired boiler, or equipment used for the preparation for delivery of heated oil to an internal combustion engine, and includes any oil pressure pumps, filters and heaters dealing with oil at a pressure of more than 0.18 N/mm².

35 *Open ro-ro spaces* are those ro-ro spaces which are either open at both ends or have an opening at one end, and are provided with adequate natural ventilation effective over their entire length through permanent openings distributed in the side plating or deckhead or from above, having a total area of at least 10% of the total area of the space sides.

36 *Open vehicle spaces* are those vehicle spaces which are either open at both ends or have an opening at one end and are provided with adequate natural ventilation effective over their entire length through permanent openings distributed in the side plating or deckhead or from above, having a total area of at least 10% of the total area of the space sides.

37 *Passenger ship* is a ship as defined in regulation I/2(f).

38 *Prescriptive requirements* means the construction characteristics, limiting dimensions, or fire safety systems specified in parts B, C, D, E or G.

39 *Public spaces* are those portions of the accommodation which are used for halls, dining rooms, lounges and similar permanently enclosed spaces.

40 *Rooms containing furniture and furnishings of restricted fire risk*, for the purpose of regulation 9, are those rooms containing furniture and furnishings of restricted fire risk (whether cabins, public spaces, offices or other types of accommodation) in which:

- .1 case furniture such as desks, wardrobes, dressing tables, bureaux, or dressers are constructed entirely of approved non-combustible materials, except that a combustible veneer not exceeding 2 mm may be used on the working surface of such articles;
- .2 free-standing furniture such as chairs, sofas, or tables are constructed with frames of non-combustible materials;

- .3 draperies, curtains and other suspended textile materials have qualities of resistance to the propagation of flame not inferior to those of wool having a mass of 0.8 kg/m^2 , this being determined in accordance with the Fire Test Procedures Code;
 - .4 floor coverings have low flame-spread characteristics;
 - .5 exposed surfaces of bulkheads, linings and ceilings have low flame-spread characteristics;
 - .6 upholstered furniture has qualities of resistance to the ignition and propagation of flame, this being determined in accordance with the Fire Test Procedures Code; and
 - .7 bedding components have qualities of resistance to the ignition and propagation of flame, this being determined in accordance with the Fire Test Procedures Code.
- 41 *Ro-ro spaces* are spaces not normally subdivided in any way and normally extending to either a substantial length or the entire length of the ship in which motor vehicles with fuel in their tanks for their own propulsion and/or goods (packaged or in bulk, in or on rail or road cars, vehicles (including road or rail tankers), trailers, containers, pallets, demountable tanks or in or on similar stowage units or other receptacles) can be loaded and unloaded normally in a horizontal direction.
- 42 *Ro-ro passenger ship* means a passenger ship with ro-ro spaces or special category spaces.
- 43 *Steel or other equivalent material* means any non-combustible material which, by itself or due to insulation provided, has structural and integrity properties equivalent to steel at the end of the applicable exposure to the standard fire test (e.g. aluminium alloy with appropriate insulation).
- 44 *Sauna* is a hot room with temperatures normally varying between 80°C and 120°C where the heat is provided by a hot surface (e.g. by an electrically heated oven). The hot room may also include the space where the oven is located and adjacent bathrooms.
- 45 *Service spaces* are those spaces used for galleys, pantries containing cooking appliances, lockers, mail and specie rooms, store-rooms, workshops other than those forming part of the machinery spaces, and similar spaces and trunks to such spaces.
- 46 *Special category spaces* are those enclosed vehicle spaces above and below the bulkhead deck, into and from which vehicles can be driven and to which passengers have access. Special category spaces may be accommodated on more than one deck provided that the total overall clear height for vehicles does not exceed 10 m.
- 47 *A standard fire test* is a test in which specimens of the relevant bulkheads or decks are exposed in a test furnace to temperatures corresponding approximately to the standard time-temperature curve in accordance with the test method specified in the Fire Test Procedures Code.
- 48 *Tanker* is a ship as defined in regulation I/2(h).
- 49 *Vehicle spaces* are cargo spaces intended for carriage of motor vehicles with fuel in their tanks for their own propulsion.
- 50 *Weather deck* is a deck which is completely exposed to the weather from above and from at least two sides.
- 51 *Safe area* in the context of a casualty is, from the perspective of habitability, any area(s) which is not flooded or which is outside the main vertical zone(s) in which a fire has occurred such that it can safely accommodate all persons on board to protect them from hazards to life or health and provide them with basic services.
- 52 *Safety centre* is a control station dedicated to the management of emergency situations. Safety systems' operation, control and/or monitoring are an integral part of the safety centre.
- 53 *Cabin balcony* is an open deck space which is provided for the exclusive use of the occupants of a single cabin and has direct access from such a cabin.

II-2

54 *Fire damper* is, for the purpose of implementing regulation 9.7 adopted by resolution MSC.365(93), as may be amended, a device installed in a ventilation duct, which under normal conditions remains open allowing flow in the duct, and is closed during a fire, preventing the flow in the duct to restrict the passage of fire. In using the above definition the following terms may be associated:

- .1 *automatic fire damper* is a fire damper that closes independently in response to exposure to fire products;
- .2 *manual fire damper* is a fire damper that is intended to be opened or closed by the crew by hand at the damper itself; and
- .3 *remotely operated fire damper* is a fire damper that is closed by the crew through a control located at a distance away from the controlled damper.

55 *Smoke damper* is, for the purpose of implementing regulation 9.7 adopted by resolution MSC.365(93), as may be amended, a device installed in a ventilation duct, which under normal conditions remains open allowing flow in the duct, and is closed during a fire, preventing the flow in the duct to restrict the passage of smoke and hot gases. A smoke damper is not expected to contribute to the integrity of a fire rated division penetrated by a ventilation duct. In using the above definition the following terms may be associated:

- .1 *automatic smoke damper* is a smoke damper that closes independently in response to exposure to smoke or hot gases;
- .2 *manual smoke damper* is a smoke damper intended to be opened or closed by the crew by hand at the damper itself; and
- .3 *remotely operated smoke damper* is a smoke damper that is closed by the crew through a control located at a distance away from the controlled damper.

56 *Vehicle carrier* means a cargo ship which only carries cargo in ro-ro spaces or vehicle spaces, and which is designed for the carriage of unoccupied motor vehicles without cargo, as cargo.

57 *Helicopter landing area* is an area on a ship designated for occasional or emergency landing of helicopters but not designed for routine helicopter operations.

58 *Winching area* is a pick-up area provided for the transfer by helicopter of personnel or stores to or from the ship, while the helicopter hovers above the deck.

SEE INTERPRETATION 4

Part B

Prevention of fire and explosion*

II-2

Regulation 4

Probability of ignition

SEE INTERPRETATION 5

1 Purpose

The purpose of this regulation is to prevent the ignition of combustible materials or flammable liquids. For this purpose, the following functional requirements shall be met:

- .1 means shall be provided to control leaks of flammable liquids;
- .2 means shall be provided to limit the accumulation of flammable vapours;
- .3 the ignitability of combustible materials shall be restricted;
- .4 ignition sources shall be restricted;
- .5 ignition sources shall be separated from combustible materials and flammable liquids; and
- .6 the atmosphere in cargo tanks shall be maintained out of the explosive range.

2 Arrangements for oil fuel, lubrication oil and other flammable oils

2.1 Limitations in the use of oils as fuel

The following limitations shall apply to the use of oil as fuel:

- .1 except as otherwise permitted by this paragraph, no oil fuel with a flashpoint of less than 60°C shall be used;†
- .2 in emergency generators, oil fuel with a flashpoint of not less than 43°C may be used;
- .3 the use of oil fuel having a flashpoint of less than 60°C but not less than 43°C may be permitted (e.g. for feeding the emergency fire pump's engines and the auxiliary machines which are not located in the machinery spaces of category A) subject to the following:
 - .1 fuel oil tanks except those arranged in double-bottom compartments shall be located outside of machinery spaces of category A;
 - .2 provisions for the measurement of oil temperature are provided on the suction pipe of the oil fuel pump;
 - .3 stop valves and/or cocks are provided on the inlet side and outlet side of the oil fuel strainers; and
 - .4 pipe joints of welded construction or of circular cone type or spherical type union joint are applied as much as possible;

* Refer to *Guidelines for measures to prevent fires in engine-rooms and cargo pump-rooms* (MSC.1/Circ.1321).

† Refer to *Recommended procedures to prevent the illegal or accidental use of low flashpoint cargo oil as fuel* (resolution A.565(14)).

- .4 in cargo ships, to which part G of chapter II-1 is not applicable, the use of oil fuel having a lower flashpoint than otherwise specified in paragraph 2.1.1, for example crude oil, may be permitted provided that such fuel is not stored in any machinery space and subject to the approval by the Administration of the complete installation; and
- .5 in ships, to which part G of chapter II-1 is applicable, the use of oil fuel having a lower flashpoint than otherwise specified in paragraph 2.1.1 is permitted.

2.2 Arrangements for oil fuel

In a ship in which oil fuel is used, the arrangements for the storage, distribution and utilization of the oil fuel shall be such as to ensure the safety of the ship and persons on board and shall at least comply with the following provisions.

2.2.1 Location of oil fuel systems

As far as practicable, parts of the oil fuel system containing heated oil under pressure exceeding 0.18 N/mm² shall not be placed in a concealed position such that defects and leakage cannot readily be observed. The machinery spaces in way of such parts of the oil fuel system shall be adequately illuminated.

2.2.2 Ventilation of machinery spaces

The ventilation of machinery spaces shall be sufficient under normal conditions to prevent accumulation of oil vapour.

2.2.3 Oil fuel tanks

2.2.3.1 Fuel oil, lubrication oil and other flammable oils shall not be carried in forepeak tanks.

2.2.3.2 As far as practicable, oil fuel tanks shall be part of the ship's structure and shall be located outside machinery spaces of category A. Where oil fuel tanks, other than double-bottom tanks, are necessarily located adjacent to or within machinery spaces of category A, at least one of their vertical sides shall be contiguous to the machinery space boundaries, and shall preferably have a common boundary with the double-bottom tanks, and the area of the tank boundary common with the machinery spaces shall be kept to a minimum.* Where such tanks are situated within the boundaries of machinery spaces of category A they shall not contain oil fuel having a flashpoint of less than 60°C. In general, the use of free-standing oil fuel tanks shall be avoided. When such tanks are employed their use shall be prohibited in category A machinery spaces on passenger ships. Where permitted, they shall be placed in an oil-tight spill tray of ample size having a suitable drain pipe leading to a suitably sized spill oil tank.

2.2.3.3 No oil fuel tank shall be situated where spillage or leakage therefrom can constitute a fire or explosion hazard by falling on heated surfaces.

2.2.3.4 Oil fuel pipes, which, if damaged, would allow oil to escape from a storage, settling or daily service tank having a capacity of 500 L and above situated above the double bottom, shall be fitted with a cock or valve directly on the tank capable of being closed from a safe position outside the space concerned in the event of a fire occurring in the space in which such tanks are situated. In the special case of deep tanks situated in any shaft or pipe tunnel or similar space, valves on the tank shall be fitted, but control in the event of fire may be effected by means of an additional valve on the pipe or pipes outside the tunnel or similar space. If such an additional valve is fitted in the machinery space, it shall be operated from a position outside this space. The controls for remote operation of the valve for the emergency generator fuel tank shall be in a separate location from the controls for remote operation of other valves for tanks located in machinery spaces.

2.2.3.5 Safe and efficient means of ascertaining the amount of oil fuel contained in any oil fuel tank shall be provided.

* Refer to *Unified interpretations of SOLAS chapter II-2* (MSC.1/Circ.1322).

2.2.3.5.1 Where sounding pipes are used, they shall not terminate in any space where the risk of ignition of spillage from the sounding pipe might arise. In particular, they shall not terminate in passenger or crew spaces. As a general rule, they shall not terminate in machinery spaces. However, where the Administration considers that these latter requirements are impracticable, it may permit termination of sounding pipes in machinery spaces on condition that all of the following requirements are met:

- .1 an oil-level gauge is provided meeting the requirements of paragraph 2.2.3.5.2;
- .2 the sounding pipes terminate in locations remote from ignition hazards unless precautions are taken, such as the fitting of effective screens, to prevent the oil fuel in the case of spillage through the terminations of the sounding pipes from coming into contact with a source of ignition; and
- .3 the terminations of sounding pipes are fitted with self-closing blanking devices and with a small-diameter self-closing control cock located below the blanking device for the purpose of ascertaining before the blanking device is opened that oil fuel is not present. Provisions shall be made so as to ensure that any spillage of oil fuel through the control cock involves no ignition hazard.

2.2.3.5.2 Other oil-level gauges may be used in place of sounding pipes subject to the following conditions:

- .1 in passenger ships, such gauges shall not require penetration below the top of the tank and their failure or overfilling of the tanks shall not permit release of fuel; and
- .2 in cargo ships, the failure of such gauges or overfilling of the tank shall not permit release of fuel into the space. The use of cylindrical gauge glasses is prohibited. The Administration may permit the use of oil-level gauges with flat glasses and self-closing valves between the gauges and fuel tanks.

2.2.3.5.3 The means prescribed in paragraph 2.2.3.5.2 which are acceptable to the Administration shall be maintained in the proper condition to ensure their continued accurate functioning in service.

2.2.4 Prevention of overpressure

Provisions shall be made to prevent overpressure in any oil tank or in any part of the oil fuel system, including the filling pipes served by pumps on board. Air and overflow pipes and relief valves shall discharge to a position where there is no risk of fire or explosion from the emergence of oils and vapour and shall not lead into crew spaces, passenger spaces nor into special category spaces, closed ro-ro spaces, machinery spaces or similar spaces.

2.2.5 Oil fuel piping

2.2.5.1 Oil fuel pipes and their valves and fittings shall be of steel or other approved material, except that restricted use of flexible pipes shall be permissible in positions where the Administration is satisfied that they are necessary.* Such flexible pipes and end attachments shall be of approved fire-resisting materials of adequate strength and shall be constructed to the satisfaction of the Administration. For valves fitted to oil fuel tanks and under static pressure, steel or spheroidal-graphite cast iron may be accepted. However, ordinary cast iron valves may be used in piping systems where the design pressure is lower than 7 bar and the design temperature is below 60°C.

2.2.5.2 External high-pressure fuel delivery lines between the high-pressure fuel pumps and fuel injectors shall be protected with a jacketed piping system capable of containing fuel from a high-pressure line failure. A jacketed pipe incorporates an outer pipe into which the high-pressure fuel pipe is placed, forming a permanent assembly. The jacketed piping system shall include a means for collection of leakages and arrangements shall be provided with an alarm in case of a fuel line failure.

2.2.5.3 Oil fuel lines shall not be located immediately above or near units of high temperature, including boilers, steam pipelines, exhaust manifolds, silencers or other equipment required to be insulated by paragraph 2.2.6. As far as practicable, oil fuel lines shall be arranged far apart from hot surfaces, electrical

* Refer to recommendations published by the International Organization for Standardization, in particular publications ISO 15540:1999, *Ships and marine technology – Fire resistance of hose assemblies – Test methods* and ISO 15541:1999, *Ships and marine technology – Fire resistance of hose assemblies – Requirements for the test bench*.

installations or other sources of ignition and shall be screened or otherwise suitably protected to avoid oil spray or oil leakage onto the sources of ignition. The number of joints in such piping systems shall be kept to a minimum.

2.2.5.4 Components of a diesel engine fuel system shall be designed considering the maximum peak pressure which will be experienced in service, including any high-pressure pulses which are generated and transmitted back into the fuel supply and spill lines by the action of fuel injection pumps. Connections within the fuel supply and spill lines shall be constructed having regard to their ability to prevent pressurized oil fuel leaks while in service and after maintenance.

2.2.5.5 In multi-engine installations which are supplied from the same fuel source, means of isolating the fuel supply and spill piping to individual engines shall be provided. The means of isolation shall not affect the operation of the other engines and shall be operable from a position not rendered inaccessible by a fire on any of the engines.

2.2.5.6 Where the Administration may permit the conveying of oil and combustible liquids through accommodation and service spaces, the pipes conveying oil or combustible liquids shall be of a material approved by the Administration having regard to the fire risk.

2.2.6 Protection of high-temperature surfaces

2.2.6.1 Surfaces with temperatures above 220°C which may be impinged as a result of a fuel system failure shall be properly insulated.

2.2.6.2 Precautions shall be taken to prevent any oil that may escape under pressure from any pump, filter or heater from coming into contact with heated surfaces.

2.3 Arrangements for lubricating oil

2.3.1 The arrangements for the storage, distribution and utilization of oil used in pressure lubrication systems shall be such as to ensure the safety of the ship and persons on board. The arrangements made in machinery spaces of category A, and whenever practicable in other machinery spaces, shall at least comply with the provisions of paragraphs 2.2.1, 2.2.3.3, 2.2.3.4, 2.2.3.5, 2.2.4, 2.2.5.1, 2.2.5.3 and 2.2.6, except that:

- .1 this does not preclude the use of sight-flow glasses in lubricating systems provided that they are shown by testing to have a suitable degree of fire resistance; and
- .2 sounding pipes may be authorized in machinery spaces; however, the requirements of paragraphs 2.2.3.5.1.1 and 2.2.3.5.1.3 need not be applied on condition that the sounding pipes are fitted with appropriate means of closure.

2.3.2 The provisions of paragraph 2.2.3.4 shall also apply to lubricating oil tanks except those having a capacity less than 500 L, storage tanks on which valves are closed during the normal operation mode of the ship, or where it is determined that an unintended operation of a quick-closing valve on the oil lubricating tank would endanger the safe operation of the main propulsion and essential auxiliary machinery.

2.4 Arrangements for other flammable oils

The arrangements for the storage, distribution and utilization of other flammable oils employed under pressure in power transmission systems, control and activating systems and heating systems shall be such as to ensure the safety of the ship and persons on board. Suitable oil collecting arrangements for leaks shall be fitted below hydraulic valves and cylinders. In locations where means of ignition are present, such arrangements shall at least comply with the provisions of paragraphs 2.2.3.3, 2.2.3.5, 2.2.5.3 and 2.2.6 and with the provisions of paragraphs 2.2.4 and 2.2.5.1 in respect of strength and construction.

2.5 Arrangements for oil fuel in periodically unattended machinery spaces

In addition to the requirements of paragraphs 2.1 to 2.4, the oil fuel and lubricating oil systems in a periodically unattended machinery space shall comply with the following:

- .1 where daily service oil fuel tanks are filled automatically, or by remote control, means shall be provided to prevent overflow spillages. Other equipment which treats flammable liquids automatically

- (e.g. oil fuel purifiers) which, whenever practicable, shall be installed in a special space reserved for purifiers and their heaters, shall have arrangements to prevent overflow spillages; and
- .2 where daily service oil fuel tanks or settling tanks are fitted with heating arrangements, a high temperature alarm shall be provided if the flashpoint of the oil fuel can be exceeded.

3 Arrangements for gaseous fuel for domestic purposes

Gaseous fuel systems used for domestic purposes shall be approved by the Administration. Storage of gas bottles shall be located on the open deck or in a well-ventilated space which opens only to the open deck.

4 Miscellaneous items of ignition sources and ignitability

4.1 Electric radiators

Electric radiators, if used, shall be fixed in position and so constructed as to reduce fire risks to a minimum. No such radiators shall be fitted with an element so exposed that clothing, curtains, or other similar materials can be scorched or set on fire by heat from the element.

4.2 Waste receptacles

Waste receptacles shall be constructed of non-combustible materials with no openings in the sides or bottom.

4.3 Insulation surfaces protected against oil penetration

In spaces where penetration of oil products is possible, the surface of insulation shall be impervious to oil or oil vapours.

4.4 Primary deck coverings

Primary deck coverings, if applied within accommodation and service spaces and control stations, or if applied on cabin balconies of passenger ships constructed on or after 1 July 2008, shall be of approved material which will not readily ignite, this being determined in accordance with the Fire Test Procedures Code.

5 Cargo areas of tankers

5.1 Separation of cargo oil tanks

5.1.1 Cargo pump-rooms, cargo tanks, slop tanks and cofferdams shall be positioned forward of machinery spaces. However, oil fuel bunker tanks need not be forward of machinery spaces. Cargo tanks and slop tanks shall be isolated from machinery spaces by cofferdams, cargo pump-rooms, oil bunker tanks or ballast tanks. Pump-rooms containing pumps and their accessories for ballasting those spaces situated adjacent to cargo tanks and slop tanks and pumps for oil fuel transfer shall be considered as equivalent to a cargo pump-room within the context of this regulation provided that such pump-rooms have the same safety standard as that required for cargo pump-rooms. Pump-rooms intended solely for ballast or oil fuel transfer, however, need not comply with the requirements of regulation 10.9. The lower portion of the pump-room may be recessed into machinery spaces of category A to accommodate pumps, provided that the deck head of the recess is in general not more than one third of the moulded depth above the keel, except that in the case of ships of not more than 25,000 tonnes deadweight, where it can be demonstrated that for reasons of access and satisfactory piping arrangements this is impracticable, the Administration may permit a recess in excess of such height, but not exceeding one half of the moulded depth above the keel.

5.1.2 Main cargo control stations, control stations, accommodation and service spaces (excluding isolated cargo handling gear lockers) shall be positioned aft of cargo tanks, slop tanks, and spaces which isolate cargo or slop tanks from machinery spaces, but not necessarily aft of the oil fuel bunker tanks and ballast tanks, and shall be arranged in such a way that a single failure of a deck or bulkhead shall not permit the entry of gas or fumes from the cargo tanks into main cargo control stations, control stations, or accommodation and

service spaces. A recess provided in accordance with paragraph 5.1.1 need not be taken into account when the position of these spaces is being determined.

5.1.3 However, where deemed necessary, the Administration may permit main cargo control stations, control stations, accommodation and service spaces forward of the cargo tanks, slop tanks and spaces which isolate cargo and slop tanks from machinery spaces, but not necessarily forward of oil fuel bunker tanks or ballast tanks. Machinery spaces, other than those of category A, may be permitted forward of the cargo tanks and slop tanks provided they are isolated from the cargo tanks and slop tanks by cofferdams, cargo pump-rooms, oil fuel bunker tanks or ballast tanks, and have at least one portable fire extinguisher. In cases where they contain internal combustion machinery, one approved foam-type extinguisher of at least 45 L capacity or equivalent shall be arranged in addition to portable fire extinguishers. If operation of a semi-portable fire extinguisher is impracticable, this fire extinguisher may be replaced by two additional portable fire extinguishers. Main cargo control stations, control stations and accommodation and service spaces shall be arranged in such a way that a single failure of a deck or bulkhead shall not permit the entry of gas or fumes from the cargo tanks into such spaces. In addition, where deemed necessary for the safety or navigation of the ship, the Administration may permit machinery spaces containing internal combustion machinery not being main propulsion machinery having an output greater than 375 kW to be located forward of the cargo area provided the arrangements are in accordance with the provisions of this paragraph.

5.1.4 In combination carriers only:

- .1** The slop tanks shall be surrounded by cofferdams except where the boundaries of the slop tanks are part of the hull, main cargo deck, cargo pump-room bulkhead or oil fuel bunker tank. These cofferdams shall not be open to a double bottom, pipe tunnel, pump-room or other enclosed space, nor shall they be used for cargo or ballast and shall not be connected to piping systems serving oil cargo or ballast. Means shall be provided for filling the cofferdams with water and for draining them. Where the boundary of a slop tank is part of the cargo pump-room bulkhead, the pump-room shall not be open to the double bottom, pipe tunnel or other enclosed space; however, openings provided with gastight bolted covers may be permitted;
- .2** Means shall be provided for isolating the piping connecting the pump-room with the slop tanks referred to in paragraph 5.1.4.1. The means of isolation shall consist of a valve followed by a spectacle flange or a spool piece with appropriate blank flanges. This arrangement shall be located adjacent to the slop tanks, but where this is unreasonable or impracticable, it may be located within the pump-room directly after the piping penetrates the bulkhead. A separate permanently installed pumping and piping arrangement incorporating a manifold, provided with a shut-off valve and a blank flange, shall be provided for discharging the contents of the slop tanks directly to the open deck for disposal to shore reception facilities when the ship is in the dry cargo mode. When the transfer system is used for slop transfer in the dry cargo mode, it shall have no connection to other systems. Separation from other systems by means of removal of spool pieces may be accepted;
- .3** Hatches and tank cleaning openings to slop tanks shall only be permitted on the open deck and shall be fitted with closing arrangements. Except where they consist of bolted plates with bolts at watertight spacing, these closing arrangements shall be provided with locking arrangements under the control of the responsible ship's officer; and
- .4** Where cargo wing tanks are provided, cargo oil lines below deck shall be installed inside these tanks. However, the Administration may permit cargo oil lines to be placed in special ducts provided these are capable of being adequately cleaned and ventilated to the satisfaction of the Administration. Where cargo wing tanks are not provided, cargo oil lines below deck shall be placed in special ducts.

5.1.5 Where the fitting of a navigation position above the cargo area is shown to be necessary, it shall be for navigation purposes only and it shall be separated from the cargo tank deck by means of an open space with a height of at least 2 m. The fire protection requirements for such a navigation position shall be those required for control stations, as specified in regulation 9.2.4.2 and other provisions for tankers, as applicable.

5.1.6 Means shall be provided to keep deck spills away from the accommodation and service areas. This may be accomplished by provision of a permanent continuous coaming of a height of at least 300 mm, extending from side to side. Special consideration shall be given to the arrangements associated with stern loading.

5.2 Restriction on boundary openings

5.2.1 Except as permitted in paragraph 5.2.2, access doors, air inlets and openings to accommodation spaces, service spaces, control stations and machinery spaces shall not face the cargo area. They shall be located on the transverse bulkhead not facing the cargo area or on the outboard side of the superstructure or deckhouse at a distance of at least 4% of the length of the ship, but not less than 3 m from the end of the superstructure or deckhouse facing the cargo area. This distance need not exceed 5 m.

SEE INTERPRETATION 6

5.2.2 The Administration may permit access doors in boundary bulkheads facing the cargo area or within the 5 m limits specified in paragraph 5.2.1, to main cargo control stations and to such service spaces used as provision rooms, store-rooms and lockers, provided they do not give access directly or indirectly to any other space containing or providing for accommodation, control stations or service spaces such as galleys, pantries or workshops, or similar spaces containing sources of vapour ignition. The boundary of such a space shall be insulated to "A-60" class standard, with the exception of the boundary facing the cargo area. Bolted plates for the removal of machinery may be fitted within the limits specified in paragraph 5.2.1. Wheelhouse doors and windows may be located within the limits specified in paragraph 5.2.1 so long as they are designed to ensure that the wheelhouse can be made rapidly and efficiently gastight and vapourtight.

SEE INTERPRETATION 6

5.2.3 Windows and sidescuttles facing the cargo area and on the sides of the superstructures and deckhouses within the limits specified in paragraph 5.2.1 shall be of the fixed (non-opening) type. Such windows and sidescuttles, except wheelhouse windows, shall be constructed to "A-60" class standard except that "A-0" class standard is acceptable for windows and sidescuttles outside the limit specified in regulation 9.2.4.2.5.

5.2.4 Where there is permanent access from a pipe tunnel to the main pump-room, a watertight door shall be fitted complying with the requirements of regulation II-1/13-1.2 and, in addition, with the following:

- .1** in addition to the bridge operation, the watertight door shall be capable of being manually closed from outside the main pump-room entrance; and
- .2** the watertight door shall be kept closed during normal operations of the ship except when access to the pipe tunnel is required.

5.2.5 Permanent approved gastight lighting enclosures for illuminating cargo pump-rooms may be permitted in bulkheads and decks separating cargo pump-rooms and other spaces provided they are of adequate strength and the integrity and gastightness of the bulkhead or deck is maintained.

5.2.6 The arrangement of ventilation inlets and outlets and other deckhouse and superstructure boundary space openings shall be such as to complement the provisions of paragraph 5.3 and regulation 11.6. Such vents, especially for machinery spaces, shall be situated as far aft as practicable. Due consideration in this regard shall be given when the ship is equipped to load or discharge at the stern. Sources of ignition such as electrical equipment shall be so arranged as to avoid an explosion hazard.

5.3 Cargo tank venting

5.3.1 General requirements

The venting systems of cargo tanks shall be entirely distinct from the air pipes of the other compartments of the ship. The arrangements and position of openings in the cargo tank deck from which emission of flammable vapours can occur shall be such as to minimize the possibility of flammable vapours being admitted to enclosed spaces containing a source of ignition, or collecting in the vicinity of deck machinery and equipment which may constitute an ignition hazard. In accordance with this general principle, the criteria in paragraphs 5.3.2 to 5.3.5 and regulation 11.6 will apply.

5.3.2 Venting arrangements

5.3.2.1 The venting arrangements in each cargo tank may be independent or combined with other cargo tanks and may be incorporated into the inert gas piping.

5.3.2.2 Where the arrangements are combined with other cargo tanks, either stop valves or other acceptable means shall be provided to isolate each cargo tank. Where stop valves are fitted, they shall be provided with locking arrangements which shall be under the control of the responsible ship's officer. There shall be a clear visual indication of the operational status of the valves or other acceptable means. Where tanks have been isolated, it shall be ensured that relevant isolating valves are opened before cargo loading or ballasting or discharging of those tanks is commenced. Any isolation must continue to permit the flow caused by thermal variations in a cargo tank in accordance with regulation 11.6.1.1. For tankers constructed on or after 1 January 2017, any isolation shall also continue to permit the passage of large volumes of vapour, air or inert gas mixtures during cargo loading and ballasting, or during discharging in accordance with regulation 11.6.1.2.

5.3.2.3 If cargo loading and ballasting or discharging of a cargo tank or cargo tank group which is isolated from a common venting system is intended, that cargo tank or cargo tank group shall be fitted with a means for over-pressure or under-pressure protection as required in regulation 11.6.3.2.

5.3.2.4 The venting arrangements shall be connected to the top of each cargo tank and shall be self-draining to the cargo tanks under all normal conditions of trim and list of the ship. Where it may not be possible to provide self-draining lines, permanent arrangements shall be provided to drain the vent lines to a cargo tank.

5.3.3 Safety devices in venting systems

The venting system shall be provided with devices to prevent the passage of flame into the cargo tanks. The design, testing and locating of these devices shall comply with the requirements established by the Administration based on the guidelines developed by the Organization.* Ullage openings shall not be used for pressure equalization. They shall be provided with self-closing and tightly sealing covers. Flame arresters and screens are not permitted in these openings.

5.3.4 Vent outlets for cargo handling and ballasting

5.3.4.1 Vent outlets for cargo loading, discharging and ballasting required by regulation 11.6.1.2 shall:

- .1.1 permit the free flow of vapour mixtures; or
- .1.2 permit the throttling of the discharge of the vapour mixtures to achieve a velocity of not less than 30 m/s;

SEE INTERPRETATION 6

- .2 be so arranged that the vapour mixture is discharged vertically upwards;
- .3 where the method is by free flow of vapour mixtures, be such that the outlet shall be not less than 6 m above the cargo tank deck or fore and aft gangway if situated within 4 m of the gangway and located not less than 10 m measured horizontally from the nearest air intakes and openings to enclosed spaces containing a source of ignition and from deck machinery, which may include anchor windlass and chain locker openings, and equipment which may constitute an ignition hazard; and
- .4 where the method is by high-velocity discharge, be located at a height not less than 2 m above the cargo tank deck and not less than 10 m measured horizontally from the nearest air intakes and openings to enclosed spaces containing a source of ignition and from deck machinery, which may include anchor windlass and chain locker openings, and equipment which may constitute an ignition hazard. These outlets shall be provided with high-velocity devices of an approved type.

* Refer to *Revised standards for the design, testing and locating of devices to prevent the passage of flame into cargo tanks in tankers* (MSC/Circ.677, as amended) and *Revised factors to be taken into consideration when designing cargo tank venting and gas-freeing arrangements* (MSC/Circ.731).

5.3.4.2 The arrangements for the venting of vapours displaced from the cargo tanks during loading and ballasting shall comply with paragraph 5.3 and regulation 11.6 and shall consist of either one or more mast risers, or a number of high-velocity vents. The inert gas supply main may be used for such venting.

5.3.5 Isolation of slop tanks in combination carriers

In combination carriers, the arrangements for isolating slop tanks containing oil or oil residues from other cargo tanks shall consist of blank flanges which will remain in position at all times when cargoes other than liquid cargoes referred to in regulation 1.6.1 are carried.

5.4 Ventilation

5.4.1 Ventilation systems in cargo pump-rooms

Cargo pump-rooms shall be mechanically ventilated and discharges from the exhaust fans shall be led to a safe place on the open deck. The ventilation of these rooms shall have sufficient capacity to minimize the possibility of accumulation of flammable vapours. The number of air changes shall be at least 20 per hour, based upon the gross volume of the space. The air ducts shall be arranged so that all of the space is effectively ventilated. The ventilation shall be of the suction type using fans of the non-sparking type.

5.4.2 Ventilation systems in combination carriers

In combination carriers, cargo spaces and any enclosed spaces adjacent to cargo spaces shall be capable of being mechanically ventilated. The mechanical ventilation may be provided by portable fans. An approved fixed gas warning system capable of monitoring flammable vapours shall be provided in cargo pump-rooms, pipe ducts and cofferdams, as referred to in paragraph 5.1.4, adjacent to slop tanks. Suitable arrangements shall be made to facilitate measurement of flammable vapours in all other spaces within the cargo area. Such measurements shall be made possible from the open deck or easily accessible positions.

5.5 Inert gas systems

5.5.1 Application

SEE INTERPRETATION 7

5.5.1.1 For tankers of 20,000 tonnes deadweight and upwards constructed on or after 1 July 2002 but before 1 January 2016, the protection of the cargo tanks shall be achieved by a fixed inert gas system in accordance with the requirements of the Fire Safety Systems Code, as adopted by resolution MSC.98(73), except that the Administration may accept other equivalent systems or arrangements, as described in paragraph 5.5.4.

5.5.1.2 For tankers of 8,000 tonnes deadweight and upwards constructed on or after 1 January 2016 when carrying cargoes described in regulation 1.6.1 or 1.6.2, the protection of the cargo tanks shall be achieved by a fixed inert gas system in accordance with the requirements of the Fire Safety Systems Code, except that the Administration may accept other equivalent systems or arrangements, as described in paragraph 5.5.4.

5.5.1.3 Tankers operating with a cargo tank cleaning procedure using crude oil washing shall be fitted with an inert gas system complying with the Fire Safety Systems Code and with fixed tank washing machines. However, inert gas systems fitted on tankers constructed on or after 1 July 2002 but before 1 January 2016 shall comply with the Fire Safety Systems Code, as adopted by resolution MSC.98(73).

5.5.1.4 Tankers required to be fitted with inert gas systems shall comply with the following provisions:

- .1** double-hull spaces shall be fitted with suitable connections for the supply of inert gas;
- .2** where hull spaces are connected to a permanently fitted inert gas distribution system, means shall be provided to prevent hydrocarbon gases from the cargo tanks entering the double-hull spaces through the system; and

- .3 where such spaces are not permanently connected to an inert gas distribution system, appropriate means shall be provided to allow connection to the inert gas main.

5.5.2 Inert gas systems of chemical tankers and gas carriers

5.5.2.1 The requirements for inert gas systems contained in the Fire Safety Systems Code need not be applied to chemical tankers constructed before 1 January 2016, including those constructed before 1 July 2012, and all gas carriers:

- .1 when carrying cargoes described in regulation 1.6.1, provided that they comply with the requirements for inert gas systems on chemical tankers established by the Administration, based on the guidelines developed by the Organization;* or
- .2 when carrying flammable cargoes other than crude oil or petroleum products such as cargoes listed in chapters 17 and 18 of the International Bulk Chemical Code, provided that the capacity of tanks used for their carriage does not exceed 3,000 m³ and the individual nozzle capacities of tank washing machines do not exceed 17.5 m³/h and the total combined throughput from the number of machines in use in a cargo tank at any one time does not exceed 110 m³/h.

5.5.3 General requirements for inert gas systems

5.5.3.1 The inert gas system shall be capable of inerting, purging and gas-freeing empty tanks and maintaining the atmosphere in cargo tanks with the required oxygen content.

5.5.3.2 Tankers fitted with a fixed inert gas system shall be provided with a closed ullage system.

5.5.4 Requirements for equivalent systems

5.5.4.1 The Administration may, after having given consideration to the ship's arrangement and equipment, accept other fixed installations, in accordance with regulation 1/5 and paragraph 5.5.4.3.

5.5.4.2 For tankers of 8,000 tonnes deadweight and upwards but less than 20,000 tonnes deadweight constructed on or after 1 January 2016, in lieu of fixed installations as required by paragraph 5.5.4.1, the Administration may accept other equivalent arrangements or means of protection in accordance with regulation 1/5 and paragraph 5.5.4.3.

5.5.4.3 Equivalent systems or arrangements shall:

- .1 be capable of preventing dangerous accumulations of explosive mixtures in intact cargo tanks during normal service throughout the ballast voyage and necessary in-tank operations; and
- .2 be so designed as to minimize the risk of ignition from the generation of static electricity by the system itself.

5.6 Inerting, purging and gas-freeing

5.6.1 Arrangements for purging and/or gas-freeing shall be such as to minimize the hazards due to dispersal of flammable vapours in the atmosphere and to flammable mixtures in a cargo tank.

5.6.2 The procedure for cargo tank purging and/or gas-freeing shall be carried out in accordance with regulation 16.3.2.

5.6.3 The arrangements for inerting, purging or gas-freeing of empty tanks as required in paragraph 5.5.3.1 shall be to the satisfaction of the Administration and shall be such that the accumulation of hydrocarbon vapours in pockets formed by the internal structural members in a tank is minimized and that:

- .1 on individual cargo tanks, the gas outlet pipe, if fitted, shall be positioned as far as practicable from the inert gas/air inlet and in accordance with paragraph 5.3 and regulation 11.6. The inlet of such

* Refer to Regulation for inert gas systems on chemical tankers (resolution A.567(14) and Corr.1).

outlet pipes may be located either at deck level or at not more than 1 m above the bottom of the tank;

- .2 the cross-sectional area of such gas outlet pipe referred to in paragraph 5.6.3.1 shall be such that an exit velocity of at least 20 m/s can be maintained when any three tanks are being simultaneously supplied with inert gas. Their outlets shall extend not less than 2 m above deck level; and
- .3 each gas outlet referred to in paragraph 5.6.3.2 shall be fitted with suitable blanking arrangements.

5.7 Gas measurement and detection

5.7.1 Portable instrument

Tankers shall be equipped with at least one portable instrument for measuring oxygen and one for measuring flammable vapour concentrations, together with a sufficient set of spares. Suitable means shall be provided for the calibration of such instruments.

SEE INTERPRETATIONS 8 AND 9

5.7.2 Arrangements for gas measurement in double-hull spaces and double-bottom spaces

5.7.2.1 Suitable portable instruments for measuring oxygen and flammable vapour concentrations in double-hull spaces and double-bottom spaces shall be provided. In selecting these instruments, due attention shall be given to their use in combination with the fixed gas sampling line systems referred to in paragraph 5.7.2.2.

5.7.2.2 Where the atmosphere in double-hull spaces cannot be reliably measured using flexible gas sampling hoses, such spaces shall be fitted with permanent gas sampling lines. The configuration of gas sampling lines shall be adapted to the design of such spaces.

5.7.2.3 The materials of construction and dimensions of gas sampling lines shall be such as to prevent restriction. Where plastic materials are used, they shall be electrically conductive.

5.7.3 Arrangements for fixed hydrocarbon gas detection systems in double-hull and double-bottom spaces of oil tankers

5.7.3.1 In addition to the requirements in paragraphs 5.7.1 and 5.7.2, oil tankers of 20,000 tonnes deadweight and above, constructed on or after 1 January 2012, shall be provided with a fixed hydrocarbon gas detection system complying with the Fire Safety Systems Code for measuring hydrocarbon gas concentrations in all ballast tanks and void spaces of double-hull and double-bottom spaces adjacent to the cargo tanks, including the forepeak tank and any other tanks and spaces under the bulkhead deck adjacent to cargo tanks.

SEE INTERPRETATION 10

5.7.3.2 Oil tankers provided with constant operative inerting systems for such spaces need not be equipped with fixed hydrocarbon gas detection equipment.

5.7.3.3 Notwithstanding the above, cargo pump-rooms subject to the provisions of paragraph 5.10 need not comply with the requirements of this paragraph.

5.8 Air supply to double-hull spaces and double-bottom spaces

Double-hull spaces and double-bottom spaces shall be fitted with suitable connections for the supply of air.

5.9 Protection of cargo area

Drip pans for collecting cargo residues in cargo lines and hoses shall be provided in the area of pipe and hose connections under the manifold area. Cargo hoses and tank washing hoses shall have electrical continuity over their entire lengths, including couplings and flanges (except shore connections), and shall be earthed for removal of electrostatic charges.

5.10 Protection of cargo pump-rooms

5.10.1 In tankers:

- .1 cargo pumps, ballast pumps and stripping pumps, installed in cargo pump-rooms and driven by shafts passing through pump-room bulkheads shall be fitted with temperature sensing devices for bulkhead shaft glands, bearings and pump casings. A continuous audible and visual alarm signal shall be automatically effected in the cargo control room or the pump control station;
- .2 lighting in cargo pump-rooms, except emergency lighting, shall be interlocked with ventilation such that the ventilation shall be in operation when switching on the lighting. Failure of the ventilation system shall not cause the lighting to go out;
- .3 a system for continuous monitoring of the concentration of hydrocarbon gases shall be fitted. Sampling points or detector heads shall be located in suitable positions in order that potentially dangerous leakages are readily detected. When the hydrocarbon gas concentration reaches a pre-set level, which shall not be higher than 10% of the lower flammable limit, a continuous audible and visual alarm signal shall be automatically effected in the pump-room, engine control room, cargo control room and navigation bridge to alert personnel to the potential hazard; and
- .4 all pump-rooms shall be provided with bilge level monitoring devices together with appropriately located alarms.

Regulation 5

Fire growth potential

1 Purpose

The purpose of this regulation is to limit the fire growth potential in every space of the ship. For this purpose, the following functional requirements shall be met:

- .1 means of control for the air supply to the space shall be provided;
- .2 means of control for flammable liquids in the space shall be provided; and
- .3 the use of combustible materials shall be restricted.

2 Control of air supply and flammable liquid to the space

2.1 Closing appliances and stopping devices of ventilation

2.1.1 The main inlets and outlets of all ventilation systems shall be capable of being closed from outside the spaces being ventilated. The means of closing shall be easily accessible as well as prominently and permanently marked and shall indicate whether the shut-off is open or closed.

SEE INTERPRETATION 11

2.1.2 Power ventilation of accommodation spaces, service spaces, cargo spaces, control stations and machinery spaces shall be capable of being stopped from an easily accessible position outside the space being served. This position shall not be readily cut off in the event of a fire in the spaces served.

SEE INTERPRETATION 12

2.1.3 In passenger ships carrying more than 36 passengers, power ventilation, except machinery space and cargo space ventilation and any alternative system which may be required under regulation 8.2, shall be fitted with controls so grouped that all fans may be stopped from either of two separate positions which shall be situated as far apart as practicable. Fans serving power ventilation systems to cargo spaces shall be capable of being stopped from a safe position outside such spaces.

SEE INTERPRETATION 12

2.2 Means of control in machinery spaces

2.2.1 Means of control shall be provided for opening and closure of skylights, closure of openings in funnels which normally allow exhaust ventilation and closure of ventilator dampers.

2.2.2 Means of control shall be provided for stopping ventilating fans. Controls provided for the power ventilation serving machinery spaces shall be grouped so as to be operable from two positions, one of which shall be outside such spaces. The means provided for stopping the power ventilation of the machinery spaces shall be entirely separate from the means provided for stopping ventilation of other spaces.

2.2.3 Means of control shall be provided for stopping forced and induced draught fans, oil fuel transfer pumps, oil fuel unit pumps, lubricating oil service pumps, thermal oil circulating pumps and oil separators (purifiers). However, paragraphs 2.2.4 and 2.2.5 need not apply to oily water separators.

2.2.4 The controls required in paragraphs 2.2.1 to 2.2.3 and in regulation 4.2.2.3.4 shall be located outside the space concerned so they will not be cut off in the event of fire in the space they serve.

2.2.5 In passenger ships, the controls required in paragraphs 2.2.1 to 2.2.4 and in regulations 8.3.3 and 9.5.2.3 and the controls for any required fire-extinguishing system shall be situated at one control position or grouped in as few positions as possible to the satisfaction of the Administration. Such positions shall have a safe access from the open deck.

2.3 Additional requirements for means of control in periodically unattended machinery spaces

2.3.1 For periodically unattended machinery spaces, the Administration shall give special consideration to maintaining the fire integrity of the machinery spaces, the location and centralization of the fire-extinguishing system controls, the required shutdown arrangements (e.g. ventilation, fuel pumps, etc.) and that additional fire-extinguishing appliances and other fire-fighting equipment and breathing apparatus may be required.

2.3.2 In passenger ships, these requirements shall be at least equivalent to those of machinery spaces normally attended.

3 Fire protection materials

3.1 Use of non-combustible materials

3.1.1 Insulating materials

Insulating materials shall be non-combustible, except in cargo spaces, mail rooms, baggage rooms and refrigerated compartments of service spaces. Vapour barriers and adhesives used in conjunction with insulation, as well as the insulation of pipe fittings for cold service systems, need not be of non-combustible materials, but they shall be kept to the minimum quantity practicable and their exposed surfaces shall have low flame-spread characteristics.

3.1.2 Ceilings and linings

3.1.2.1 In passenger ships, except in cargo spaces, all linings, grounds, draught stops and ceilings shall be of non-combustible material except in mail rooms, baggage rooms, saunas or refrigerated compartments of service spaces.

3.1.2.2 In cargo ships, all linings, ceilings, draught stops and their associated grounds shall be of non-combustible materials in the following spaces:

- .1 in accommodation and service spaces and control stations for ships where method IC is specified as referred to in regulation 9.2.3.1; and
- .2 in corridors and stairway enclosures serving accommodation and service spaces and control stations for ships where methods IIC or IIIC are specified as referred to in regulation 9.2.3.1.

3.1.3 Partial bulkheads and decks on passenger ships

3.1.3.1 Partial bulkheads or decks used to subdivide a space for utility or artistic treatment shall be of non-combustible materials.

3.1.3.2 Linings, ceilings and partial bulkheads or decks used to screen or to separate adjacent cabin balconies shall be of non-combustible materials. Cabin balconies on passenger ships constructed before 1 July 2008 shall comply with the requirements of this paragraph by the first survey after 1 July 2008.

3.2 Use of combustible materials

3.2.1 General

3.2.1.1 In passenger ships, "A", "B" or "C" class divisions in accommodation and service spaces and cabin balconies which are faced with combustible materials, facings, mouldings, decorations and veneers shall comply with the provisions of paragraphs 3.2.2 to 3.2.4 and regulation 6. However, traditional wooden benches and wooden linings on bulkheads and ceilings are permitted in saunas and such materials need not be subject to the calculations prescribed in paragraphs 3.2.2 and 3.2.3. However, the provisions of paragraph 3.2.3 need not be applied to cabin balconies.

3.2.1.2 In cargo ships, non-combustible bulkheads, ceilings and linings fitted in accommodation and service spaces may be faced with combustible materials, facings, mouldings, decorations and veneers provided such spaces are bounded by non-combustible bulkheads, ceilings and linings in accordance with the provisions of paragraphs 3.2.2 to 3.2.4 and regulation 6.

3.2.2 Maximum calorific value of combustible materials

Combustible materials used on the surfaces and linings specified in paragraph 3.2.1 shall have a calorific value* not exceeding 45 MJ/m² of the area for the thickness used. The requirements of this paragraph are not applicable to the surfaces of furniture fixed to linings or bulkheads.

3.2.3 Total volume of combustible materials

Where combustible materials are used in accordance with paragraph 3.2.1, they shall comply with the following requirements:

- .1 The total volume of combustible facings, mouldings, decorations and veneers in accommodation and service spaces shall not exceed a volume equivalent to 2.5 mm veneer on the combined area of the walls and ceiling linings. Furniture fixed to linings, bulkheads or decks need not be included in the calculation of the total volume of combustible materials; and
- .2 in the case of ships fitted with an automatic sprinkler system complying with the provisions of the Fire Safety Systems Code, the above volume may include some combustible material used for erection of "C" class divisions.

3.2.4 Low flame-spread characteristics of exposed surfaces

The following surfaces shall have low flame-spread characteristics in accordance with the Fire Test Procedures Code:

3.2.4.1 In passenger ships:

- .1 exposed surfaces in corridors and stairway enclosures and of bulkhead and ceiling linings in accommodation and service spaces (except saunas) and control stations;
- .2 surfaces and grounds in concealed or inaccessible spaces in accommodation and service spaces and control stations; and
- .3 exposed surfaces of cabin balconies, except for natural hard wood decking systems.

* Refer to the recommendations published by the International Organization for Standardization, in particular ISO/DIS 1716, *Reaction to fire tests for products – Determination of the gross heat of combustion (calorific value)*.

3.2.4.2 In cargo ships:

- .1 exposed surfaces in corridors and stairway enclosures and of ceilings in accommodation and service spaces (except saunas) and control stations; and
- .2 surfaces and grounds in concealed or inaccessible spaces in accommodation and service spaces and control stations.

3.3 Furniture in stairway enclosures of passenger ships

Furniture in stairway enclosures shall be limited to seating. It shall be fixed, limited to six seats on each deck in each stairway enclosure, be of restricted fire risk determined in accordance with the Fire Test Procedures Code, and shall not restrict the passenger escape route. The Administration may permit additional seating in the main reception area within a stairway enclosure if it is fixed, non-combustible and does not restrict the passenger escape route. Furniture shall not be permitted in passenger and crew corridors forming escape routes in cabin areas. In addition to the above, lockers of non-combustible material, providing storage for non-hazardous safety equipment required by these regulations, may be permitted. Drinking water dispensers and ice cube machines may be permitted in corridors provided they are fixed and do not restrict the width of the escape routes. This applies as well to decorative flower or plant arrangements, statues or other objects of art such as paintings and tapestries in corridors and stairways.

3.4 Furniture and furnishings on cabin balconies of passenger ships

On passenger ships, furniture and furnishings on cabin balconies shall comply with regulations 3.40.1, 3.40.2, 3.40.3, 3.40.6 and 3.40.7 unless such balconies are protected by a fixed pressure water-spraying and fixed fire detection and fire alarm systems complying with regulations 7.10 and 10.6.1.3. Passenger ships constructed before 1 July 2008 shall comply with the requirements of this paragraph by the first survey after 1 July 2008.

Regulation 6*Smoke generation potential and toxicity***1 Purpose**

The purpose of this regulation is to reduce the hazard to life from smoke and toxic products generated during a fire in spaces where persons normally work or live. For this purpose, the quantity of smoke and toxic products released from combustible materials, including surface finishes, during fire shall be limited.

2.1 Paints, varnishes and other finishes

Paints, varnishes and other finishes used on exposed interior surfaces shall not be capable of producing excessive quantities of smoke and toxic products, this being determined in accordance with the Fire Test Procedures Code.

2.2 On passenger ships constructed on or after 1 July 2008, paints, varnishes and other finishes used on exposed surfaces of cabin balconies, excluding natural hard wood decking systems, shall not be capable of producing excessive quantities of smoke and toxic products, this being determined in accordance with the Fire Test Procedures Code.

3.1 Primary deck coverings

Primary deck coverings, if applied within accommodation and service spaces and control stations, shall be of approved material which will not give rise to smoke or toxic or explosive hazards at elevated temperatures, this being determined in accordance with the Fire Test Procedures Code.

3.2 On passenger ships constructed on or after 1 July 2008, primary deck coverings on cabin balconies shall not give rise to smoke, toxic or explosive hazards at elevated temperatures, this being determined in accordance with the Fire Test Procedures Code.

Part C

Suppression of fire

Regulation 7

Detection and alarm

1 Purpose

The purpose of this regulation is to detect a fire in the space of origin and to provide for alarm for safe escape and fire-fighting activity. For this purpose, the following functional requirements shall be met:

- .1 fixed fire detection and fire alarm system installations shall be suitable for the nature of the space, fire growth potential and potential generation of smoke and gases;
- .2 manually operated call points shall be placed effectively to ensure a readily accessible means of notification; and
- .3 fire patrols shall provide an effective means of detecting and locating fires and alerting the navigation bridge and fire teams.

2 General requirements

2.1 A fixed fire detection and fire alarm system shall be provided in accordance with the provisions of this regulation.

2.2 A fixed fire detection and fire alarm system and a sample extraction smoke detection system required in this regulation and other regulations in this part shall be of an approved type and comply with the Fire Safety Systems Code.

2.3 Where a fixed fire detection and fire alarm system is required for the protection of spaces other than those specified in paragraph 5.1, at least one detector complying with the Fire Safety Systems Code shall be installed in each such space.

2.4 A fixed fire detection and fire alarm system for passenger ships shall be capable of remotely and individually identifying each detector and manually operated call point.

3 Initial and periodical tests

3.1 The function of fixed fire detection and fire alarm systems required by the relevant regulations of this chapter shall be tested under varying conditions of ventilation after installation.

3.2 The function of fixed fire detection and fire alarm systems shall be periodically tested to the satisfaction of the Administration by means of equipment producing hot air at the appropriate temperature, or smoke or aerosol particles having the appropriate range of density or particle size, or other phenomena associated with incipient fires to which the detector is designed to respond.

4 Protection of machinery spaces

4.1 Installation

A fixed fire detection and fire alarm system shall be installed in:

- .1 periodically unattended machinery spaces;
- .2 machinery spaces where:
 - .1 the installation of automatic and remote control systems and equipment has been approved in lieu of continuous manning of the space; and
 - .2 the main propulsion and associated machinery, including the main sources of electrical power, are provided with various degrees of automatic or remote control and are under continuous manned supervision from a control room; and
- .3 enclosed spaces containing incinerators.

4.2 Design

The fixed fire detection and fire alarm system required in paragraph 4.1.1 shall be so designed and the detectors so positioned as to detect rapidly the onset of fire in any part of those spaces and under any normal conditions of operation of the machinery and variations of ventilation as required by the possible range of ambient temperatures. Except in spaces of restricted height and where their use is specially appropriate, detection systems using only thermal detectors shall not be permitted. The detection system shall initiate audible and visual alarms distinct in both respects from the alarms of any other system not indicating fire, in sufficient places to ensure that the alarms are heard and observed on the navigation bridge and by a responsible engineer officer. When the navigation bridge is unmanned, the alarm shall sound in a place where a responsible member of the crew is on duty.

5 Protection of accommodation and service spaces and control stations

5.1 Smoke detectors in accommodation spaces

Smoke detectors shall be installed in all stairways, corridors and escape routes within accommodation spaces as provided in paragraphs 5.2, 5.3 and 5.4. Consideration shall be given to the installation of special purpose smoke detectors within ventilation ducting.

5.2 Requirements for passenger ships carrying more than 36 passengers

A fixed fire detection and fire alarm system shall be so installed and arranged as to provide smoke detection in service spaces, control stations and accommodation spaces, including corridors, stairways and escape routes within accommodation spaces. Smoke detectors need not be fitted in private bathrooms and galleys. Spaces having little or no fire risk such as voids, public toilets, carbon dioxide rooms and similar spaces need not be fitted with a fixed fire detection and alarm system. Detectors fitted in cabins, when activated, shall also be capable of emitting, or cause to be emitted, an audible alarm within the space where they are located.

5.3 Requirements for passenger ships carrying not more than 36 passengers

There shall be installed throughout each separate zone, whether vertical or horizontal, in all accommodation and service spaces and, where it is considered necessary by the Administration, in control stations, except spaces which afford no substantial fire risk such as void spaces, sanitary spaces, etc., either:

- .1 a fixed fire detection and fire alarm system so installed and arranged as to detect the presence of fire in such spaces and providing smoke detection in corridors, stairways and escape routes within accommodation spaces. Detectors fitted in cabins, when activated, shall also be capable of emitting, or cause to be emitted, an audible alarm within the space where they are located; or

- .2 an automatic sprinkler, fire detection and fire alarm system of an approved type complying with the relevant requirements of the Fire Safety Systems Code and so installed and arranged as to protect such spaces and, in addition, a fixed fire detection and fire alarm system and so installed and arranged as to provide smoke detection in corridors, stairways and escape routes within accommodation spaces.

II-2

5.4 Protection of atriums in passenger ships

The entire main vertical zone containing the atrium shall be protected throughout with a smoke detection system.

5.5 Cargo ships

SEE INTERPRETATION 13

Accommodation and service spaces and control stations of cargo ships shall be protected by a fixed fire detection and fire alarm system and/or an automatic sprinkler, fire detection and fire alarm system as follows, depending on a protection method adopted in accordance with regulation 9.2.3.1.

5.5.1 Method IC – A fixed fire detection and fire alarm system shall be so installed and arranged as to provide smoke detection in all corridors, stairways and escape routes within accommodation spaces.

5.5.2 Method IIC – An automatic sprinkler, fire detection and fire alarm system of an approved type complying with the relevant requirements of the Fire Safety Systems Code shall be so installed and arranged as to protect accommodation spaces, galleys and other service spaces, except spaces which afford no substantial fire risk such as void spaces, sanitary spaces, etc. In addition, a fixed fire detection and fire alarm system shall be so installed and arranged as to provide smoke detection in all corridors, stairways and escape routes within accommodation spaces.

5.5.3 Method IIIC – A fixed fire detection and fire alarm system shall be so installed and arranged as to detect the presence of fire in all accommodation spaces and service spaces, providing smoke detection in corridors, stairways and escape routes within accommodation spaces, except spaces which afford no substantial fire risk such as void spaces, sanitary spaces, etc. In addition, a fixed fire detection and fire alarm system shall be so installed and arranged as to provide smoke detection in all corridors, stairways and escape routes within accommodation spaces.

6 Protection of cargo spaces in passenger ships

A fixed fire detection and fire alarm system or a sample extraction smoke detection system shall be provided in any cargo space which, in the opinion of the Administration, is not accessible, except where it is shown to the satisfaction of the Administration that the ship is engaged on voyages of such short duration that it would be unreasonable to apply this requirement.

7 Manually operated call points

Manually operated call points complying with the Fire Safety Systems Code shall be installed throughout the accommodation spaces, service spaces and control stations. One manually operated call point shall be located at each exit. Manually operated call points shall be readily accessible in the corridors of each deck such that no part of the corridor is more than 20 m from a manually operated call point.

8 Fire patrols in passenger ships

8.1 Fire patrols

For ships carrying more than 36 passengers, an efficient patrol system shall be maintained so that an outbreak of fire may be promptly detected. Each member of the fire patrol shall be trained to be familiar with the arrangements of the ship as well as the location and operation of any equipment he may be called upon to use.

8.2 Inspection hatches

The construction of ceilings and bulkheads shall be such that it will be possible, without impairing the efficiency of the fire protection, for the fire patrols to detect any smoke originating in concealed and inaccessible places, except where in the opinion of the Administration there is no risk of fire originating in such places.

8.3 Two-way portable radiotelephone apparatus

Each member of the fire patrol shall be provided with a two-way portable radiotelephone apparatus.

9 Fire alarm signalling systems in passenger ships*

9.1 Passenger ships shall at all times when at sea, or in port (except when out of service), be so manned or equipped as to ensure that any initial fire alarm is immediately received by a responsible member of the crew.

9.2 The control panel of fixed fire detection and fire alarm systems shall be designed on the fail-safe principle (e.g. an open detector circuit shall cause an alarm condition).

9.3 Passenger ships carrying more than 36 passengers shall have the fire detection alarms for the systems required by paragraph 5.2 centralized in a continuously manned central control station. In addition, controls for remote closing of the fire doors and shutting down the ventilation fans shall be centralized in the same location. The ventilation fans shall be capable of reactivation by the crew at the continuously manned control station. The control panels in the central control station shall be capable of indicating open or closed positions of fire doors and closed or off status of the detectors, alarms and fans. The control panel shall be continuously powered and shall have an automatic change-over to standby power supply in case of loss of normal power supply. The control panel shall be powered from the main source of electrical power and the emergency source of electrical power defined by regulation II-1/42 unless other arrangements are permitted by the regulations, as applicable.

SEE INTERPRETATION 12

9.4 A special alarm, operated from the navigation bridge or fire control station, shall be fitted to summon the crew. This alarm may be part of the ship's general alarm system and shall be capable of being sounded independently of the alarm to the passenger spaces.

10 Protection of cabin balconies on passenger ships

A fixed fire detection and fire alarm system complying with the provisions of the Fire Safety Systems Code shall be installed on cabin balconies of ships to which regulation 5.3.4 applies, when furniture and furnishings on such balconies are not as defined in regulations 3.40.1, 3.40.2, 3.40.3, 3.40.6 and 3.40.7.

Regulation 8

Control of smoke spread

1 Purpose

The purpose of this regulation is to control the spread of smoke in order to minimize the hazards from smoke. For this purpose, means for controlling smoke in atriums, control stations, machinery spaces and concealed spaces shall be provided.

2 Protection of control stations outside machinery spaces

Practicable measures shall be taken for control stations outside machinery spaces in order to ensure that ventilation, visibility and freedom from smoke are maintained so that, in the event of fire, the machinery and equipment contained therein may be supervised and continue to function effectively. Alternative and separate

* Refer to the *Code on alerts and indicators, 2009* (resolution A.1021(26), as may be amended).

means of air supply shall be provided and air inlets of the two sources of supply shall be so disposed that the risk of both inlets drawing in smoke simultaneously is minimized. At the discretion of the Administration, such requirements need not apply to control stations situated on, and opening onto, an open deck or where local closing arrangements would be equally effective. The ventilation system serving safety centres may be derived from the ventilation system serving the navigation bridge, unless located in an adjacent main vertical zone.

3 Release of smoke from machinery spaces

3.1 The provisions of this paragraph shall apply to machinery spaces of category A and, where the Administration considers it desirable, to other machinery spaces.

3.2 Suitable arrangements shall be made to permit the release of smoke, in the event of fire, from the space to be protected, subject to the provisions of regulation 9.5.2.1 The normal ventilation systems may be acceptable for this purpose.

3.3 Means of control shall be provided for permitting the release of smoke and such controls shall be located outside the space concerned so that they will not be cut off in the event of fire in the space they serve.

3.4 In passenger ships, the controls required by paragraph 3.3 shall be situated at one control position or grouped in as few positions as possible to the satisfaction of the Administration. Such positions shall have a safe access from the open deck.

4 Draught stops

Air spaces enclosed behind ceilings, panelling or linings shall be divided by close-fitting draught stops spaced not more than 14 m apart. In the vertical direction, such enclosed air spaces, including those behind linings of stairways, trunks, etc., shall be closed at each deck.

5 Smoke extraction systems in atriums of passenger ships

Atriums shall be equipped with a smoke extraction system. The smoke extraction system shall be activated by the required smoke detection system and be capable of manual control. The fans shall be sized such that the entire volume within the space can be exhausted in 10 min or less.

Regulation 9

Containment of fire

SEE INTERPRETATION 14

1 Purpose

The purpose of this regulation is to contain a fire in the space of origin. For this purpose, the following functional requirements shall be met:

- .1** the ship shall be subdivided by thermal and structural boundaries;
- .2** thermal insulation of boundaries shall have due regard to the fire risk of the space and adjacent spaces; and
- .3** the fire integrity of the divisions shall be maintained at openings and penetrations.

2 Thermal and structural boundaries

SEE INTERPRETATION 15

2.1 Thermal and structural subdivision

Ships of all types shall be subdivided into spaces by thermal and structural divisions having regard to the fire risks of the spaces.

2.2 Passenger ships

2.2.1 Main vertical zones and horizontal zones

2.2.1.1.1 In ships carrying more than 36 passengers, the hull, superstructure and deckhouses shall be subdivided into main vertical zones by "A-60" class divisions. Steps and recesses shall be kept to a minimum, but where they are necessary they shall also be "A-60" class divisions. Where a category (5), (9) or (10) space defined in paragraph 2.2.3.2.2 is on one side or where fuel oil tanks are on both sides of the division the standard may be reduced to "A-0".

2.2.1.1.2 In ships carrying not more than 36 passengers, the hull, superstructure and deckhouses in way of accommodation and service spaces shall be subdivided into main vertical zones by "A" class divisions. These divisions shall have insulation values in accordance with tables in paragraph 2.2.4.

2.2.1.2 As far as practicable, the bulkheads forming the boundaries of the main vertical zones above the bulkhead deck shall be in line with watertight subdivision bulkheads situated immediately below the bulkhead deck. The length and width of main vertical zones may be extended to a maximum of 48 m in order to bring the ends of main vertical zones to coincide with watertight subdivision bulkheads or in order to accommodate a large public space extending for the whole length of the main vertical zone provided that the total area of the main vertical zone is not greater than 1,600 m² on any deck. The length or width of a main vertical zone is the maximum distance between the furthestmost points of the bulkheads bounding it.

2.2.1.3 Such bulkheads shall extend from deck to deck and to the shell or other boundaries.

2.2.1.4 Where a main vertical zone is subdivided by horizontal "A" class divisions into horizontal zones for the purpose of providing an appropriate barrier between a zone with sprinklers and a zone without sprinklers, the divisions shall extend between adjacent main vertical zone bulkheads and to the shell or exterior boundaries of the ship and shall be insulated in accordance with the fire insulation and integrity values given in table 9.4.

2.2.1.5.1 On ships designed for special purposes, such as automobile or railroad car ferries, where the provision of main vertical zone bulkheads would defeat the purpose for which the ship is intended, equivalent means for controlling and limiting a fire shall be substituted and specifically approved by the Administration. Service spaces and ship stores shall not be located on ro-ro decks unless protected in accordance with the applicable regulations.

2.2.1.5.2 However, in a ship with special category spaces, such spaces shall comply with the applicable provisions of regulation 20 and, where such compliance would be inconsistent with other requirements for passenger ships specified in this chapter, the requirements of regulation 20 shall prevail.

2.2.2 Bulkheads within a main vertical zone

2.2.2.1 For ships carrying more than 36 passengers, bulkheads which are not required to be "A" class divisions shall be at least "B" class or "C" class divisions as prescribed in the tables in paragraph 2.2.3.

2.2.2.2 For ships carrying not more than 36 passengers, bulkheads within accommodation and service spaces which are not required to be "A" class divisions shall be at least "B" class or "C" class divisions as prescribed in the tables in paragraph 2.2.4. In addition, corridor bulkheads, where not required to be "A" class, shall be "B" class divisions which shall extend from deck to deck except:

- .1** when continuous "B" class ceilings or linings are fitted on both sides of the bulkhead, the portion of the bulkhead behind the continuous ceiling or lining shall be of material which, in thickness and composition, is acceptable in the construction of "B" class divisions, but which shall be required to meet "B" class integrity standards only in so far as is reasonable and practicable in the opinion of the Administration; and
- .2** in the case of a ship protected by an automatic sprinkler system complying with the provisions of the Fire Safety Systems Code, the corridor bulkheads may terminate at a ceiling in the corridor provided such bulkheads and ceilings are of "B" class standard in compliance with paragraph 2.2.4. All doors and frames in such bulkheads shall be of non-combustible materials and shall have the same fire integrity as the bulkhead in which they are fitted.

2.2.2.3 Bulkheads required to be “B” class divisions, except corridor bulkheads as prescribed in paragraph 2.2.2.2, shall extend from deck to deck and to the shell or other boundaries. However, where a continuous “B” class ceiling or lining is fitted on both sides of a bulkhead which is at least of the same fire resistance as the adjoining bulkhead, the bulkhead may terminate at the continuous ceiling or lining.

II-2

2.2.3 Fire integrity of bulkheads and decks in ships carrying more than 36 passengers

2.2.3.1 In addition to complying with the specific provisions for fire integrity of bulkheads and decks of passenger ships, the minimum fire integrity of all bulkheads and decks shall be as prescribed in tables 9.1 and 9.2. Where, due to any particular structural arrangements in the ship, difficulty is experienced in determining from the tables the minimum fire integrity value of any divisions, such values shall be determined to the satisfaction of the Administration.

2.2.3.2 The following requirements shall govern application of the tables:

- .1** Table 9.1 shall apply to bulkheads not bounding either main vertical zones or horizontal zones. Table 9.2 shall apply to decks not forming steps in main vertical zones nor bounding horizontal zones.
- .2** For determining the appropriate fire integrity standards to be applied to boundaries between adjacent spaces, such spaces are classified according to their fire risk as shown in categories (1) to (14) below. Where the contents and use of a space are such that there is a doubt as to its classification for the purpose of this regulation, or where it is possible to assign two or more classifications to a space, it shall be treated as a space within the relevant category having the most stringent boundary requirements. Smaller, enclosed rooms within a space that have less than 30% communicating openings to that space are considered separate spaces. The fire integrity of the boundary bulkheads and decks of such smaller rooms shall be as prescribed in tables 9.1 and 9.2. The title of each category is intended to be typical rather than restrictive. The number in parentheses preceding each category refers to the applicable column or row in the tables.
 - (1) Control stations**
 - Spaces containing emergency sources of power and lighting.
 - Wheelhouse and chartroom.
 - Spaces containing the ship's radio equipment.
 - Fire control stations.
 - Control room for propulsion machinery when located outside the propulsion machinery space.
 - Spaces containing centralized fire alarm equipment.
 - Spaces containing centralized emergency public address system stations and equipment.
 - (2) Stairways**
 - Interior stairways, lifts, totally enclosed emergency escape trunks, and escalators (other than those wholly contained within the machinery spaces) for passengers and crew and enclosures thereto.
 - In this connection, a stairway which is enclosed at only one level shall be regarded as part of the space from which it is not separated by a fire door.
 - (3) Corridors**
 - Passenger and crew corridors and lobbies.
 - (4) Evacuation stations and external escape routes**
 - Survival craft stowage area.
 - Open deck spaces and enclosed promenades forming lifeboat and liferaft embarkation and lowering stations.
 - Assembly stations, internal and external.
 - External stairs and open decks used for escape routes.
 - The ship's side to the waterline in the lightest seagoing condition, superstructure and deckhouse sides situated below and adjacent to the liferaft and evacuation slide embarkation areas.

- (5) *Open deck spaces*
Open deck spaces and enclosed promenades clear of lifeboat and liferaft embarkation and lowering stations. To be considered in this category, enclosed promenades shall have no significant fire risk, meaning that furnishings shall be restricted to deck furniture. In addition, such spaces shall be naturally ventilated by permanent openings.
Air spaces (the space outside superstructures and deckhouses).
- (6) *Accommodation spaces of minor fire risk*
Cabins containing furniture and furnishings of restricted fire risk.
Offices and dispensaries containing furniture and furnishings of restricted fire risk.
Public spaces containing furniture and furnishings of restricted fire risk and having a deck area of less than 50 m².
- (7) *Accommodation spaces of moderate fire risk*
Spaces as in category (6) above but containing furniture and furnishings of other than restricted fire risk.
Public spaces containing furniture and furnishings of restricted fire risk and having a deck area of 50 m² or more.
Isolated lockers and small store-rooms in accommodation spaces having areas less than 4 m² (in which flammable liquids are not stowed).
Motion picture projection and film stowage rooms. Diet kitchens (containing no open flame).
Cleaning gear lockers (in which flammable liquids are not stowed).
Laboratories (in which flammable liquids are not stowed).
Pharmacies.
Small drying rooms (having a deck area of 4 m² or less).
Specie rooms.
Operating rooms.
- (8) *Accommodation spaces of greater fire risk*
Public spaces containing furniture and furnishings of other than restricted fire risk and having a deck area of 50 m² or more.
Barber shops and beauty parlours.
Saunas.
Sale shops.
- (9) *Sanitary and similar spaces*
Communal sanitary facilities, showers, baths, water closets, etc.
Small laundry rooms.
Indoor swimming pool area.
Isolated pantries containing no cooking appliances in accommodation spaces.
Private sanitary facilities shall be considered a portion of the space in which they are located.
- (10) *Tanks, voids and auxiliary machinery spaces having little or no fire risk*
Water tanks forming part of the ship's structure.
Voids and cofferdams.
Auxiliary machinery spaces which do not contain machinery having a pressure lubrication system and where storage of combustibles is prohibited, such as:
 ventilation and air-conditioning rooms; windlass room; steering gear room; stabilizer equipment room; electrical propulsion motor room; rooms containing section switchboards and purely electrical equipment other than oil-filled electrical transformers (above 10 kVA); shaft alleys and pipe tunnels; and spaces for pumps and refrigeration machinery (not handling or using flammable liquids).
Closed trunks serving the spaces listed above.
Other closed trunks such as pipe and cable trunks.

Table 9.1 – Bulkheads not bounding either main vertical zones or horizontal zones

Spaces	(1)	(2)	(3)	(4)	(5)	(6)	(7)	(8)	(9)	(10)	(11)	(12)	(13)	(14)
Control stations	B-0 ^a	A-0	A-0	A-0	A-0	A-60	A-60	A-60	A-0	A-0	A-60	A-60	A-60	A-60
Stairways		A-0 ^a	A-0	A-0	A-0	A-0	A-15	A-15	A-0 ^c	A-0	A-15	A-30	A-15	A-30
Corridors			B-15	A-60	A-0	B-15	B-15	B-15	B-15	A-0	A-15	A-30	A-0	A-30
Evacuation stations and external escape routes					A-0	A-60 ^{b,d}	A-60 ^{b,d}	A-60 ^{b,d}	A-0 ^d	A-0	A-60 ^b	A-60 ^b	A-60 ^b	A-60 ^b
Open deck spaces						A-0	A-0	A-0	A-0	A-0	A-0	A-0	A-0	A-0
Accommodation spaces of minor fire risk						B-0	B-0	B-0	C	A-0	A-0	A-30	A-0	A-30
Accommodation spaces of moderate fire risk							B-0	B-0	C	A-0	A-15	A-60	A-15	A-60
Accommodation spaces of greater fire risk								B-0	C	A-0	A-30	A-60	A-15	A-60
Sanitary and similar spaces									C	A-0	A-0	A-0	A-0	A-0
Tanks, voids and auxiliary machinery spaces having little or no fire risk										A-0 ^a	A-0	A-0	A-0	A-0
Auxiliary machinery spaces, cargo spaces, cargo and other oil tanks and other similar spaces of moderate fire risk											A-0 ^a	A-0	A-0	A-15
Machinery spaces and main galleys												A-0 ^a	A-0	A-60
Store-rooms, workshops, pantries, etc.													A-0 ^a	A-0
Other spaces in which flammable liquids are stowed														A-30

See notes following table 9.2.

Table 9.2 – Decks not forming steps in main vertical zones nor bounding horizontal zones

Spaces below ↓	Spaces above →	(1)	(2)	(3)	(4)	(5)	(6)	(7)	(8)	(9)	(10)	(11)	(12)	(13)	(14)
Control stations	(1) A-30	A-30	A-30	A-15	A-0	A-0	A-0	A-15	A-30	A-0	A-0	A-0	A-60	A-0	A-60
Stairways	(2) A-0	A-0	A-0	A-0	A-0	A-0	A-0	A-0	A-0	A-0	A-0	A-0	A-30	A-0	A-30
Corridors	(3) A-15	A-0	A-0	A-0 ^a	A-60	A-0	A-0	A-15	A-15	A-0	A-0	A-0	A-30	A-0	A-30
Evacuation stations and external escape routes	(4) A-0	A-0	A-0	A-0	A-0	—	A-0	A-0	A-0	A-0	A-0	A-0	A-0	A-0	A-0
Open deck spaces	(5) A-0	A-0	A-0	A-0	A-0	—	A-0	A-0	A-0	A-0	A-0	A-0	A-0	A-0	A-0
Accommodation spaces of minor fire risk	(6) A-60	A-15	A-15	A-0	A-60	A-0	A-0	A-0	A-0	A-0	A-0	A-0	A-0	A-0	A-0
Accommodation spaces of moderate fire risk.	(7) A-60	A-15	A-15	A-15	A-60	A-0	A-0	A-15	A-15	A-0	A-0	A-0	A-0	A-0	A-0
Accommodation spaces of greater fire risk	(8) A-60	A-15	A-15	A-15	A-60	A-0	A-15	A-15	A-30	A-0	A-0	A-0	A-0	A-0	A-0
Sanitary and similar spaces	(9) A-0	A-0	A-0	A-0	A-0	A-0	A-0	A-0	A-0	A-0	A-0	A-0	A-0	A-0	A-0
Tanks, voids and auxiliary machinery spaces having little or no fire risk	(10) A-0	A-0	A-0	A-0	A-0	A-0	A-0	A-0	A-0	A-0	A-0 ^a	A-0	A-0	A-0	A-0
Auxiliary machinery spaces, cargo spaces, cargo and other oil tanks and other similar spaces of moderate fire risk	(11) A-60	A-60	A-60	A-60	A-60	A-0	A-0	A-15	A-30	A-0	A-0	A-0 ^a	A-0	A-0	A-30
Machinery spaces and main galleys	(12) A-60	A-60	A-60	A-60	A-60	A-0	A-60	A-60	A-60	A-0	A-0	A-30	A-30 ^a	A-0	A-60
Store-rooms, workshops, pantries, etc.	(13) A-60	A-30	A-30	A-15	A-60	A-0	A-15	A-30	A-30	A-0	A-0	A-0	A-0	A-0	A-0
Other spaces in which flammable liquids are stowed	(14) A-60	A-60	A-60	A-60	A-60	A-0	A-30	A-60	A-60	A-0	A-0	A-0	A-0	A-0	A-0

Notes: To be applied to tables 9.1 and 9.2, as appropriate.

^a Where adjacent spaces are in the same numerical category and superscript "a" appears, a bulkhead or deck between such spaces need not be fitted if deemed unnecessary by the Administration. For example, in category (12) a bulkhead need not be required between a galley and its annexed pantries provided the pantry bulkhead and decks maintain the integrity of the galley boundaries. A bulkhead is, however, required between a galley and machinery space even though both spaces are in category (12).

^b The ship's side, to the waterline in the lightest seagoing condition, superstructure and deckhouse sides situated below and adjacent to liferafts and evacuation slides may be reduced to "A-30".

^c Where public toilets are installed completely within the stairway enclosure, the public toilet bulkhead within the stairway enclosure can be of "B" class integrity.

^d Where spaces of categories (6), (7), (8) and (9) are located completely within the outer perimeter of the assembly station, the bulkheads of these spaces are allowed to be of "B-0" class integrity. Control positions for audio, video and light installations may be considered as part of the assembly station.

(11) Auxiliary machinery spaces, cargo spaces, cargo and other oil tanks and other similar spaces of moderate fire risk

Cargo oil tanks.

Cargo holds, trunkways and hatchways.

Refrigerated chambers.

Oil fuel tanks (where installed in a separate space with no machinery).

Shaft alleys and pipe tunnels allowing storage of combustibles.

Auxiliary machinery spaces as in category (10) which contain machinery having a pressure lubrication system or where storage of combustibles is permitted.

Oil fuel filling stations.

Spaces containing oil-filled electrical transformers (above 10 kVA).

Spaces containing turbine and reciprocating steam engine driven auxiliary generators and small internal combustion engines of power output up to 110 kW driving generators, sprinkler, drencher or fire pumps, bilge pumps, etc.

Closed trunks serving the spaces listed above.

(12) Machinery spaces and main galleys

Main propulsion machinery rooms (other than electric propulsion motor rooms) and boiler rooms.

Auxiliary machinery spaces other than those in categories (10) and (11) which contain internal combustion machinery or other oil-burning, heating or pumping units.

Main galleys and annexes.

Trunks and casings to the spaces listed above.

(13) Store-rooms, workshops, pantries, etc.

Main pantries not annexed to galleys.

Main laundry.

Large drying rooms (having a deck area of more than 4 m²).

Miscellaneous stores.

Mail and baggage rooms.

Garbage rooms.

Workshops (not part of machinery spaces, galleys, etc.).

Lockers and store-rooms having areas greater than 4 m², other than those spaces that have provisions for the storage of flammable liquids.

(14) Other spaces in which flammable liquids are stowed

Paint lockers.

Store-rooms containing flammable liquids (including dyes, medicines, etc.).

Laboratories (in which flammable liquids are stowed).

- .3 Where a single value is shown for the fire integrity of a boundary between two spaces, that value shall apply in all cases.
- .4 Notwithstanding the provisions of paragraph 2.2.2, there are no special requirements for material or integrity of boundaries where only a dash appears in the tables.
- .5 The Administration shall determine in respect of category (5) spaces whether the insulation values in table 9.1 shall apply to ends of deckhouses and superstructures, and whether the insulation values in table 9.2 shall apply to weather decks. In no case shall the requirements of category (5) of tables 9.1 or 9.2 necessitate enclosure of spaces which in the opinion of the Administration need not be enclosed.

2.2.3.3 Continuous "B" class ceilings or linings, in association with the relevant decks or bulkheads, may be accepted as contributing, wholly or in part, to the required insulation and integrity of a division.

2.2.3.4 Construction and arrangement of saunas

2.2.3.4.1 The perimeter of the sauna shall be of "A" class boundaries and may include changing rooms, showers and toilets. The sauna shall be insulated to "A-60" standard against other spaces except those inside of the perimeter and spaces of categories (5), (9) and (10).

2.2.3.4.2 Bathrooms with direct access to saunas may be considered as part of them. In such cases, the door between sauna and the bathroom need not comply with fire safety requirements.

2.2.3.4.3 The traditional wooden lining on the bulkheads and ceiling are permitted in the sauna. The ceiling above the oven shall be lined with a non-combustible plate with an air gap of at least 30 mm. The distance from the hot surfaces to combustible materials shall be at least 500 mm or the combustible materials shall be protected (e.g. non-combustible plate with an air gap of at least 30 mm).

2.2.3.4.4 The traditional wooden benches are permitted to be used in the sauna.

2.2.3.4.5 The sauna door shall open outwards by pushing.

2.2.3.4.6 Electrically heated ovens shall be provided with a timer.

2.2.4 Fire integrity of bulkheads and decks in ships carrying not more than 36 passengers

2.2.4.1 In addition to complying with the specific provisions for fire integrity of bulkheads and decks of passenger ships, the minimum fire integrity of bulkheads and decks shall be as prescribed in tables 9.3 and 9.4.

2.2.4.2 The following requirements shall govern application of the tables:

- .1 Tables 9.3 and 9.4 shall apply respectively to the bulkheads and decks separating adjacent spaces.
- .2 For determining the appropriate fire integrity standards to be applied to divisions between adjacent spaces, such spaces are classified according to their fire risk as shown in categories (1) to (11) below. Where the contents and use of a space are such that there is a doubt as to its classification for the purpose of this regulation, or where it is possible to assign two or more classifications to a space, it shall be treated as a space within the relevant category having the most stringent boundary requirements. Smaller, enclosed rooms within a space that have less than 30% communicating openings to that space are considered separate spaces. The fire integrity of the boundary bulkheads and decks of such smaller rooms shall be as prescribed in tables 9.3 and 9.4. The title of each category is intended to be typical rather than restrictive. The number in parentheses preceding each category refers to the applicable column or row in the tables.

(1) *Control stations*

- Spaces containing emergency sources of power and lighting.
- Wheelhouse and chartroom.
- Spaces containing the ship's radio equipment.
- Fire control stations.
- Control room for propulsion machinery when located outside the machinery space.
- Spaces containing centralized fire alarm equipment.

(2) *Corridors*

- Passenger and crew corridors and lobbies.

(3) *Accommodation spaces*

- Spaces as defined in regulation 3.1 excluding corridors.

(4) *Stairways*

- Interior stairways, lifts, totally enclosed emergency escape trunks, and escalators (other than those wholly contained within the machinery spaces) and enclosures thereto.
- In this connection, a stairway which is enclosed only at one level shall be regarded as part of the space from which it is not separated by a fire door.

Table 9.3 – Fire integrity of bulkheads separating adjacent spaces

Spaces	(1)	(2)	(3)	(4)	(5)	(6)	(7)	(8)	(9)	(10)	(11)
Control stations	(1) A-0 ^c	A-0	A-60	A-0	A-15	A-60	A-15	A-60	A-60	*	A-60
Corridors	(2)	C ^e	B-0 ^e	A-0 ^a B-0 ^e	B-0 ^e	A-60	A-0	A-0	A-15 A-0 ^d	*	A-30 ^e
Accommodation spaces	(3)		C ^e	A-0 ^a B-0 ^e	B-0 ^e	A-60	A-0	A-0	A-15 A-0 ^d	*	A-30 A-0 ^d
Stairways	(4)			A-0 ^a B-0 ^e	A-0 ^a B-0 ^e	A-60	A-0	A-0	A-15 A-0 ^d	*	A-30 ^e
Service spaces (low risk)	(5)				C ^e	A-60	A-0	A-0	A-0	*	A-0
Machinery spaces of category A	(6)					*	A-0	A-0	A-60	*	A-60
Other machinery spaces	(7)						A-0 ^b	A-0	A-0	*	A-0
Cargo spaces	(8)							*	A-0	*	A-0
Service spaces (high risk)	(9)								A-0 ^b	*	A-30
Open decks	(10)										A-0
Special category and ro-ro spaces	(11)										A-30 ^e

See notes following table 9.4.

Table 9.4 – Fire integrity of decks separating adjacent spaces

Spaces below ↓	Spaces above →	(1)	(2)	(3)	(4)	(5)	(6)	(7)	(8)	(9)	(10)	(11)
Control stations	(1) A-0	A-0	A-0	A-0	A-0	A-0	A-60	A-0	A-0	A-0	*	A-60 ^g
Corridors	(2) A-0	*	*	*	A-0	*	A-60	A-0	A-0	A-0	*	A-30 ^g
Accommodation spaces	(3) A-60	A-0	A-0	*	A-0	*	A-60	A-0	A-0	A-0	*	A-30 A-0 ^d
Stairways	(4) A-0	A-0	A-0	A-0	*	A-0	A-60	A-0	A-0	A-0	*	A-30 ^g
Service spaces (low risk)	(5) A-15	A-0	A-0	A-0	A-0	*	A-60	A-0	A-0	A-0	*	A-0
Machinery spaces of category A	(6) A-60	A-60	A-60	A-60	A-60	A-60	*	A-60 ^f	A-30	A-60	*	A-60
Other machinery spaces	(7) A-15	A-0	A-0	A-0	A-0	A-0	A-0	*	A-0	A-0	*	A-0
Cargo spaces	(8) A-60	A-0	A-0	A-0	A-0	A-0	A-0	A-0	*	A-0	*	A-0
Service spaces (high risk)	(9) A-60	A-30 A-0 ^d	A-30 A-0 ^d	A-30 A-0 ^d	A-30 A-0 ^d	A-0	A-60	A-0	A-0	A-0	*	A-30
Open decks	(10) *	*	*	*	*	*	*	*	*	*	*	A-0
Special category and ro-ro spaces	(11) A-60	A-30 ^g	A-30 A-0 ^d	A-30 A-0 ^d	A-30 ^g	A-0	A-60 ^g	A-0	A-0	A-30	A-0	A-30 ^g

Notes: To be applied to both tables 9.3 and 9.4 as appropriate.

^a For clarification as to which applies, see paragraphs 2.2.2 and 2.2.5.

^b Where spaces are of the same numerical category and superscript "b" appears, a bulkhead or deck of the rating shown in the tables is only required when the adjacent spaces are for a different purpose (e.g. in category (9)). A galley next to a paint room requires an "A-0" bulkhead.

^c Bulkheads separating the wheelhouse and chartroom from each other may have a "B-0" rating. No fire rating is required for those partitions separating the navigation bridge and the safety centre when the latter is within the navigation bridge.

^d See paragraphs 2.2.4.2.3 and 2.2.4.2.4.

^e For the application of paragraph 2.2.1.1.2, "B-0" and "C", where appearing in table 9.3, shall be read as "A-0".

^f Fire insulation need not be fitted if the machinery space in category (7), in the opinion of the Administration, has little or no fire risk.

^g Ships constructed before 1 July 2014 shall comply, as a minimum, with the previous requirements applicable at the time the ship was constructed, as specified in regulation 1.2.

* Where an asterisk appears in the tables, the division is required to be of steel or other equivalent material, but is not required to be of "A" class standard. However, where a deck, except in a category (10) space, is penetrated for the passage of electric cables, pipes and vent ducts, such penetrations shall be made tight to prevent the passage of flame and smoke. Divisions between control stations (emergency generators) and open decks may have air intake openings without means for closure, unless a fixed gas fire-extinguishing system is fitted.

For the application of paragraph 2.2.1.1.2, an asterisk, where appearing in table 9.4, except for categories (8) and (10), shall be read as "A-0".

- (5) *Service spaces (low risk)*
Lockers and store-rooms not having provisions for the storage of flammable liquids and having areas less than 4 m² and drying rooms and laundries.
 - (6) *Machinery spaces of category A*
Spaces as defined in regulation 3.31.
 - (7) *Other machinery spaces*
Electrical equipment rooms (auto-telephone exchange, air-conditioning duct spaces).
Spaces as defined in regulation 3.30 excluding machinery spaces of category A.
 - (8) *Cargo spaces*
All spaces used for cargo (including cargo oil tanks) and trunkways and hatchways to such spaces, other than special category spaces.
 - (9) *Service spaces (high risk)*
Galley, pantries containing cooking appliances, paint lockers, lockers and store-rooms having areas of 4 m² or more, spaces for the storage of flammable liquids, saunas and workshops other than those forming part of the machinery spaces.
 - (10) *Open decks*
Open deck spaces and enclosed promenades having little or no fire risk. To be considered in this category, enclosed promenades shall have no significant fire risk, meaning that furnishing shall be restricted to deck furniture. In addition, such spaces shall be naturally ventilated by permanent openings.
Air spaces (the space outside superstructures and deckhouses).
 - (11) *Special category and ro-ro spaces*
Spaces as defined in regulations 3.41 and 3.46.
- .3 In determining the applicable fire integrity standard of a boundary between two spaces within a main vertical zone or horizontal zone which is not protected by an automatic sprinkler system complying with the provisions of the Fire Safety Systems Code or between such zones neither of which is so protected, the higher of the two values given in the tables shall apply.
 - .4 In determining the applicable fire integrity standard of a boundary between two spaces within a main vertical zone or horizontal zone which is protected by an automatic sprinkler system complying with the provisions of the Fire Safety Systems Code or between such zones both of which are so protected, the lesser of the two values given in the tables shall apply. Where a zone with sprinklers and a zone without sprinklers meet within accommodation and service spaces, the higher of the two values given in the tables shall apply to the division between the zones.

SEE INTERPRETATION 16

2.2.4.3 Continuous "B" class ceilings or linings, in association with the relevant decks or bulkheads, may be accepted as contributing, wholly or in part, to the required insulation and integrity of a division.

2.2.4.4 External boundaries which are required in regulation 11.2 to be of steel or other equivalent material may be pierced for the fitting of windows and sidescuttles provided that there is no requirement for such boundaries of passenger ships to have "A" class integrity. Similarly, in such boundaries which are not required to have "A" class integrity, doors may be constructed of materials which are to the satisfaction of the Administration.

2.2.4.5 Saunas shall comply with paragraph 2.2.3.4.

2.2.5 Protection of stairways and lifts in accommodation area

2.2.5.1 Stairways shall be within enclosures formed of "A" class divisions, with positive means of closure at all openings, except that:

- .1 a stairway connecting only two decks need not be enclosed, provided the integrity of the deck is maintained by proper bulkheads or self-closing doors in one 'tween-deck space. When a stairway

is closed in one 'tween-deck space, the stairway enclosure shall be protected in accordance with the tables for decks in paragraphs 2.2.3 or 2.2.4; and

- .2 stairways may be fitted in the open in a public space, provided they lie wholly within the public space.

2.2.5.2 Lift trunks shall be so fitted as to prevent the passage of smoke and flame from one 'tween-deck to another and shall be provided with means of closing so as to permit the control of draught and smoke. Machinery for lifts located within stairway enclosures shall be arranged in a separate room, surrounded by steel boundaries, except that small passages for lift cables are permitted. Lifts which open into spaces other than corridors, public spaces, special category spaces, stairways and external areas shall not open into stairways included in the means of escape.

2.2.6 Arrangement of cabin balconies

On passenger ships constructed on or after 1 July 2008, non-load-bearing partial bulkheads which separate adjacent cabin balconies shall be capable of being opened by the crew from each side for the purpose of fighting fires.

2.2.7 Protection of atriums

2.2.7.1 Atriums shall be within enclosures formed of "A" class divisions having a fire rating determined in accordance with tables 9.2 and 9.4, as applicable.

2.2.7.2 Decks separating spaces within atriums shall have a fire rating determined in accordance with tables 9.2 and 9.4, as applicable.

2.3 Cargo ships except tankers

2.3.1 Methods of protection in accommodation area

2.3.1.1 One of the following methods of protection shall be adopted in accommodation and service spaces and control stations:

- .1 *Method IC* – The construction of internal divisional bulkheads of non-combustible "B" or "C" class divisions generally without the installation of an automatic sprinkler, fire detection and fire alarm system in the accommodation and service spaces, except as required by regulation 7.5.5.1; or
- .2 *Method IIC* – The fitting of an automatic sprinkler, fire detection and fire alarm system as required by regulation 7.5.5.2 for the detection and extinction of fire in all spaces in which fire might be expected to originate, generally with no restriction on the type of internal divisional bulkheads; or
- .3 *Method IIIC* – The fitting of a fixed fire detection and fire alarm system as required by regulation 7.5.5.3 in spaces in which a fire might be expected to originate, generally with no restriction on the type of internal divisional bulkheads, except that in no case shall the area of any accommodation space or spaces bounded by an "A" or "B" class division exceed 50 m². However, consideration may be given by the Administration to increasing this area for public spaces.

2.3.1.2 The requirements for the use of non-combustible materials in the construction and insulation of boundary bulkheads of machinery spaces, control stations, service spaces, etc., and the protection of the above stairway enclosures and corridors will be common to all three methods outlined in paragraph 2.3.1.1.

2.3.2 Bulkheads within accommodation area

2.3.2.1 Bulkheads required to be "B" class divisions shall extend from deck to deck and to the shell or other boundaries. However, where a continuous "B" class ceiling or lining is fitted on both sides of the bulkhead, the bulkhead may terminate at the continuous ceiling or lining.

2.3.2.2 *Method IC* – Bulkheads not required by this or other regulations for cargo ships to be "A" or "B" class divisions shall be of at least "C" class construction.

2.3.2.3 *Method IIC* – There shall be no restriction on the construction of bulkheads not required by this or other regulations for cargo ships to be "A" or "B" class divisions except in individual cases where "C" class bulkheads are required in accordance with table 9.5.

2.3.2.4 Method IIIC – There shall be no restriction on the construction of bulkheads not required for cargo ships to be “A” or “B” class divisions except that the area of any accommodation space or spaces bounded by a continuous “A” or “B” class division shall in no case exceed 50 m², except in individual cases where “C” class bulkheads are required in accordance with table 9.5. However, consideration may be given by the Administration to increasing this area for public spaces.

2.3.3 Fire integrity of bulkheads and decks

2.3.3.1 In addition to complying with the specific provisions for fire integrity of bulkheads and decks of cargo ships, the minimum fire integrity of bulkheads and decks shall be as prescribed in tables 9.5 and 9.6.

2.3.3.2 The following requirements shall govern application of the tables:

- .1** Tables 9.5 and 9.6 shall apply respectively to the bulkheads and decks separating adjacent spaces.
- .2** For determining the appropriate fire integrity standards to be applied to divisions between adjacent spaces, such spaces are classified according to their fire risk as shown in categories (1) to (11) below. Where the contents and use of a space are such that there is a doubt as to its classification for the purpose of this regulation, or where it is possible to assign two or more classifications to a space, it shall be treated as a space within the relevant category having the most stringent boundary requirements. Smaller, enclosed rooms within a space that have less than 30% communicating openings to that space are considered separate spaces. The fire integrity of the boundary bulkheads and decks of such smaller rooms shall be as prescribed in tables 9.5 and 9.6. The title of each category is intended to be typical rather than restrictive. The number in parentheses preceding each category refers to the applicable column or row in the tables.
 - (1) Control stations**
Spaces containing emergency sources of power and lighting.
Wheelhouse and chartroom.
Spaces containing the ship’s radio equipment.
Fire control stations.
Control room for propulsion machinery when located outside the machinery space.
Spaces containing centralized fire alarm equipment.
 - (2) Corridors**
Corridors and lobbies.
 - (3) Accommodation spaces**
Spaces as defined in regulation 3.1, excluding corridors.
 - (4) Stairways**
Interior stairway, lifts, totally enclosed emergency escape trunks, and escalators (other than those wholly contained within the machinery spaces) and enclosures thereto.
In this connection, a stairway which is enclosed only at one level shall be regarded as part of the space from which it is not separated by a fire door.
 - (5) Service spaces (low risk)**
Lockers and store-rooms not having provisions for the storage of flammable liquids and having areas less than 4 m² and drying rooms and laundries.
 - (6) Machinery spaces of category A**
Spaces as defined in regulation 3.31.
 - (7) Other machinery spaces**
Electrical equipment rooms (auto-telephone exchange, air-conditioning duct spaces).
Spaces as defined in regulation 3.30, excluding machinery spaces of category A.
 - (8) Cargo spaces**
All spaces used for cargo (including cargo oil tanks) and trunkways and hatchways to such spaces.

Table 9.5 – Fire integrity of bulkheads separating adjacent spaces

Spaces	(1)	(2)	(3)	(4)	(5)	(6)	(7)	(8)	(9)	(10)	(11)
Control stations	A-0 ^e	A-0	A-60	A-0	A-15	A-60	A-15	A-60	A-60	*	A-60
Corridors		C	B-0	B-0 A-0 ^c	B-0	A-60	A-0	A-0	A-0	*	A-30
Accommodation spaces			C ^{a, b}	B-0 A-0 ^c	B-0	A-60	A-0	A-0	A-0	*	A-30
Stairways				B-0 A-0 ^c	B-0 A-0 ^c	A-60	A-0	A-0	A-0	*	A-30
Service spaces (low risk)					C	A-60	A-0	A-0	A-0	*	A-0
Machinery spaces of category A						*	A-0	A-0 ^g	A-60	*	A-60 ^f
Other machinery spaces							A-0 ^d	A-0	A-0	*	A-0
Cargo spaces								*	A-0	*	A-0
Service spaces (high risk)									A-0 ^d	*	A-30
Open decks										-	A-0
Ro-ro and vehicle spaces											A-30 ^j

See notes following table 9.6.

SEE INTERPRETATION 17

Table 9.6 – Fire integrity of decks separating adjacent spaces

Spaces below ↓	Spaces above →		(1)	(2)	(3)	(4)	(5)	(6)	(7)	(8)	(9)	(10)	(11)
Control stations	(1)	A-0	A-0	A-0	A-0	A-0	A-0	A-60	A-0	A-0	A-0	*	A-60
Corridors	(2)	A-0	*	*	*	A-0	*	A-60	A-0	A-0	A-0	*	A-30
Accommodation spaces	(3)	A-60	A-0	A-0	*	A-0	*	A-60	A-0	A-0	A-0	*	A-30
Stairways	(4)	A-0	A-0	A-0	A-0	*	A-0	A-60	A-0	A-0	A-0	*	A-30
Service spaces (low risk)	(5)	A-15	A-0	A-0	A-0	A-0	*	A-60	A-0	A-0	A-0	*	A-0
Machinery spaces of category A	(6)	A-60	A-60	A-60	A-60	A-60	*	A-60 ⁱ	A-60	A-30	A-60	*	A-60
Other machinery spaces	(7)	A-15	A-0	A-0	A-0	A-0	A-0	A-0	*	A-0	A-0	*	A-0
Cargo spaces	(8)	A-60	A-0	A-0	A-0	A-0	A-0	A-0	A-0	*	A-0	*	A-0
Service spaces (high risk)	(9)	A-60	A-0	A-0	A-0	A-0	A-0	A-60	A-0	A-0	A-0 ^d	*	A-30
Open decks	(10)	*	*	*	*	*	*	*	*	*	*	*	A-0 ^f
Ro-ro and vehicle spaces	(11)	A-60	A-30	A-30	A-30	A-30	A-0	A-60	A-0	A-0	A-30	A-0 ^l	A-30 ^l

Notes: To be applied to tables 9.5 and 9.6, as appropriate.

^a No special requirements are imposed upon bulkheads in methods IIC and IIC fire protection.

^b In case of method IIC, "B" class bulkheads of "B-0" rating shall be provided between spaces or groups of spaces of 50 m² and over in area.

^c For clarification as to which applies, see paragraphs 2.3.2 and 2.3.4.

^d Where spaces are of the same numerical category and superscript "d" appears, a bulkhead or deck of the rating shown in the tables is only required when the adjacent spaces are for a different purpose (e.g. in category (9)). A galley next to a galley does not require a bulkhead, but a galley next to a paint room requires an "A-0" bulkhead.

^e Bulkheads separating the wheelhouse, chartroom and radio room from each other may have a "B-0" rating.

^f An "A-0" rating may be used if no dangerous goods are intended to be carried or if such goods are stowed not less than 3 m horizontally from such a bulkhead.

^g For cargo spaces in which dangerous goods are intended to be carried, regulation 19.3.8 applies.

^h Deleted.

ⁱ Fire insulation need not be fitted in the machinery space in category (7) if, in the opinion of the Administration, it has little or no fire risk.

^j Ships constructed before 1 July 2014 shall comply, as a minimum, with the previous requirements applicable at the time the ship was constructed, as specified in regulation 1.2.

* Where an asterisk appears in the tables, the division is required to be of steel or other equivalent material but is not required to be of "A" class standard. However, where a deck, except an open deck, is penetrated for the passage of electric cables, pipes and vent ducts, such penetrations shall be made tight to prevent the passage of flame and smoke. Divisions between control stations (emergency generators) and open decks may have air intake openings without means for closure, unless a fixed gas fire-extinguishing system is fitted.

SEE INTERPRETATION 17

(9) *Service spaces (high risk)*

Galleys, pantries containing cooking appliances, saunas, paint lockers and store-rooms having areas of 4 m² or more, spaces for the storage of flammable liquids, and workshops other than those forming part of the machinery spaces.

(10) *Open decks*

Open deck spaces and enclosed promenades having little or no fire risk. To be considered in this category, enclosed promenades shall have no significant fire risk, meaning that furnishings shall be restricted to deck furniture. In addition, such spaces shall be naturally ventilated by permanent openings.

Air spaces (the space outside superstructures and deckhouses).

(11) *Ro-ro and vehicle spaces*

Ro-ro spaces as defined in regulation 3.41.

Vehicle spaces as defined in regulation 3.49.

SEE INTERPRETATION 16

2.3.3.3 Continuous "B" class ceilings or linings, in association with the relevant decks or bulkheads, may be accepted as contributing, wholly or in part, to the required insulation and integrity of a division.

2.3.3.4 External boundaries which are required in regulation 11.2 to be of steel or other equivalent material may be pierced for the fitting of windows and sidescuttles provided that there is no requirement for such boundaries of cargo ships to have "A" class integrity. Similarly, in such boundaries which are not required to have "A" class integrity, doors may be constructed of materials which are to the satisfaction of the Administration.

2.3.3.5 Saunas shall comply with paragraph 2.2.3.4.

2.3.4 *Protection of stairways and lift trunks in accommodation spaces, service spaces and control stations*

2.3.4.1 Stairways which penetrate only a single deck shall be protected, at a minimum, at one level by at least "B-0" class divisions and self-closing doors. Lifts which penetrate only a single deck shall be surrounded by "A-0" class divisions with steel doors at both levels. Stairways and lift trunks which penetrate more than a single deck shall be surrounded by at least "A-0" class divisions and be protected by self-closing doors at all levels.

2.3.4.2 On ships having accommodation for 12 persons or less, where stairways penetrate more than a single deck and where there are at least two escape routes direct to the open deck at every accommodation level, the "A-0" requirements of paragraph 2.3.4.1 may be reduced to "B-0".

2.4 Tankers

2.4.1 *Application*

For tankers, only method IC as defined in paragraph 2.3.1.1 shall be used.

2.4.2 *Fire integrity of bulkheads and decks*

2.4.2.1 In lieu of paragraph 2.3 and in addition to complying with the specific provisions for fire integrity of bulkheads and decks of tankers, the minimum fire integrity of bulkheads and decks shall be as prescribed in tables 9.7 and 9.8.

2.4.2.2 The following requirements shall govern application of the tables:

- .1 Tables 9.7 and 9.8 shall apply respectively to the bulkhead and decks separating adjacent spaces.
- .2 For determining the appropriate fire integrity standards to be applied to divisions between adjacent spaces, such spaces are classified according to their fire risk as shown in categories (1) to (10) below. Where the contents and use of a space are such that there is a doubt as to its classification

for the purpose of this regulation, or where it is possible to assign two or more classifications to a space, it shall be treated as a space within the relevant category having the most stringent boundary requirements. Smaller, enclosed areas within a space that have less than 30% communicating openings to that space are considered separate areas. The fire integrity of the boundary bulkheads and decks of such smaller spaces shall be as prescribed in tables 9.7 and 9.8. The title of each category is intended to be typical rather than restrictive. The number in parentheses preceding each category refers to the applicable column or row in the tables.

(1) Control stations

Spaces containing emergency sources of power and lighting.

Wheelhouse and chartroom.

Spaces containing the ship's radio equipment.

Fire control stations.

Control room for propulsion machinery when located outside the machinery space.

Spaces containing centralized fire alarm equipment.

(2) Corridors

Corridors and lobbies.

(3) Accommodation spaces

Spaces as defined in regulation 3.1, excluding corridors.

(4) Stairways

Interior stairways, lifts, totally enclosed emergency escape trunks, and escalators (other than those wholly contained within the machinery spaces) and enclosures thereto.

In this connection, a stairway which is enclosed only at one level shall be regarded as part of the space from which it is not separated by a fire door.

(5) Service spaces (low risk)

Lockers and store-rooms not having provisions for the storage of flammable liquids and having areas less than 4 m² and drying rooms and laundries.

(6) Machinery spaces of category A

Spaces as defined in regulation 3.31.

(7) Other machinery spaces

Electrical equipment rooms (auto-telephone exchange and air-conditioning duct spaces).

Spaces as defined in regulation 3.30, excluding machinery spaces of category A.

(8) Cargo pump-rooms

Spaces containing cargo pumps and entrances and trunks to such spaces.

(9) Service spaces (high risk)

Galleys, pantries containing cooking appliances, saunas, paint lockers and store-rooms having areas of 4 m² or more, spaces for the storage of flammable liquids and workshops other than those forming part of the machinery spaces.

(10) Open decks

Open deck spaces and enclosed promenades having little or no fire risk. To be considered in this category, enclosed promenades shall have no significant fire risk, meaning that furnishings shall be restricted to deck furniture. In addition, such spaces shall be naturally ventilated by permanent openings.

Air spaces (the space outside superstructures and deckhouses).

SEE INTERPRETATION 16

2.4.2.3 Continuous "B" class ceilings or linings, in association with the relevant decks or bulkheads, may be accepted as contributing, wholly or in part, to the required insulation and integrity of a division.

Table 9.7 – Fire integrity of bulkheads separating adjacent spaces

Spaces	(1)	(2)	(3)	(4)	(5)	(6)	(7)	(8)	(9)	(10)
Control stations	(1) A-0 ^c	A-0	A-60	A-0	A-15	A-60	A-15	A-60	A-60	*
Corridors	(2)	C	B-0	B-0 A-0 ^a	B-0	A-60	A-0	A-60	A-0	*
Accommodation spaces	(3)		C	B-0 A-0 ^a	B-0	A-60	A-0	A-60	A-0	*
Stairways	(4)			B-0 A-0 ^a	B-0 A-0 ^a	A-60	A-0	A-60	A-0	*
Service spaces (low risk)	(5)				C	A-60	A-0	A-60	A-0	*
Machinery spaces of category A	(6)					*	A-0	A-0 ^d	A-60	*
Other machinery spaces	(7)						A-0 ^b	A-0	A-0	*
Cargo pump-rooms	(8)							*	A-60	*
Service spaces (high risk)	(9)								A-0 ^b	*
Open decks	(10)									—

See notes following table 9.8.

Table 9.8 – Fire integrity of decks separating adjacent spaces

Spaces below ↓	Spaces above →	(1)	(2)	(3)	(4)	(5)	(6)	(7)	(8)	(9)	(10)
Control stations	(1) A-0	A-0	A-0	A-0	A-0	A-0	A-60	A-0	–	A-0	*
Corridors	(2) A-0	*	*	*	A-0	*	A-60	A-0	–	A-0	*
Accommodation spaces	(3) A-60	A-0	A-0	*	A-0	*	A-60	A-0	–	A-0	*
Stairways	(4) A-0	A-0	A-0	A-0	*	A-0	A-60	A-0	–	A-0	*
Service spaces (low risk)	(5) A-15	A-0	A-0	A-0	A-0	*	A-60	A-0	–	A-0	*
Machinery spaces of category A	(6) A-60	A-60	A-60	A-60	A-60	A-60	*	A-60 ^e	A-0	A-60	*
Other machinery spaces	(7) A-15	A-0	A-0	A-0	A-0	A-0	A-0	*	A-0	A-0	*
Cargo pump rooms	(8) –	–	–	–	–	–	A-0 ^d	A-0	*	–	*
Service spaces (high risk)	(9) A-60	A-0	A-0	A-0	A-0	A-0	A-60	A-0	–	A-0 ^b	*
Open decks	(10) *	*	*	*	*	*	*	*	*	*	–

Notes: To be applied to tables 9.7 and 9.8 as appropriate.

^a For clarification as to which applies, see paragraphs 2.3.2 and 2.3.4.

^b Where spaces are of the same numerical category and superscript "b" appears, a bulkhead or deck of the rating shown in the tables is only required when the adjacent spaces are for a different purpose (e.g. in category (9)). A galley next to a galley does not require a bulkhead but a galley next to a paint room requires an "A-0" bulkhead.

^c Bulkheads separating the wheelhouse, chartroom and radio room from each other may have a "B-0" rating.

^d Bulkheads and decks between cargo pump-rooms and machinery spaces of category A may be penetrated by cargo pump shaft glands and similar gland penetrations, provided that gastight seals with efficient lubrication or other means of ensuring the permanence of the gas seal are fitted in way of the bulkheads or deck.

^e Fire insulation need not be fitted in the machinery space in category (7) if, in the opinion of the Administration, it has little or no fire risk.

* Where an asterisk appears in the table, the division is required to be of steel or other equivalent material, but is not required to be of "A" class standard. However, where a deck, except an open deck, is penetrated for the passage of electric cables, pipes and vent ducts, such penetrations shall be made tight to prevent the passage of flame and smoke. Divisions between control stations (emergency generators) and open decks may have air intake openings without means for closure, unless a fixed gas fire-extinguishing system is fitted.

2.4.2.4 External boundaries which are required in regulation 11.2 to be of steel or other equivalent material may be pierced for the fitting of windows and sidescuttles provided that there is no requirement for such boundaries of tankers to have "A" class integrity. Similarly, in such boundaries which are not required to have "A" class integrity, doors may be constructed of materials which are to the satisfaction of the Administration.

2.4.2.5 Exterior boundaries of superstructures and deckhouses enclosing accommodation and including any overhanging decks which support such accommodation shall be constructed of steel and insulated to "A-60" standard for the whole of the portions which face the cargo area and on the outward sides for a distance of 3 m from the end boundary facing the cargo area. The distance of 3 m shall be measured horizontally and parallel to the middle line of the ship from the boundary which faces the cargo area at each deck level. In the case of the sides of those superstructures and deckhouses, such insulation shall be carried up to the underside of the deck of the navigation bridge.

2.4.2.6 Skylights to cargo pump-rooms shall be of steel, shall not contain any glass and shall be capable of being closed from outside the pump-room.

2.4.2.7 Construction and arrangement of saunas shall comply with paragraph 2.2.3.4.

3 Penetrations in fire-resisting divisions and prevention of heat transmission

3.1 Where "A" class divisions are penetrated, such penetrations shall be tested in accordance with the Fire Test Procedures Code, subject to the provisions of paragraph 4.1.1.5. In the case of ventilation ducts, paragraphs 7.1.2 and 7.3.1 apply. However, where a pipe penetration is made of steel or equivalent material having a thickness of 3 mm or greater and a length of not less than 900 mm (preferably 450 mm on each side of the division), and there are no openings, testing is not required. Such penetrations shall be suitably insulated by extension of the insulation at the same level of the division.

3.2 Where "B" class divisions are penetrated for the passage of electric cables, pipes, trunks, ducts, etc., or for the fitting of ventilation terminals, lighting fixtures and similar devices, arrangements shall be made to ensure that the fire resistance is not impaired, subject to the provisions of paragraph 7.3.2. Pipes other than steel or copper that penetrate "B" class divisions shall be protected by either:

- .1** a fire-tested penetration device suitable for the fire resistance of the division pierced and the type of pipe used; or
- .2** a steel sleeve, having a thickness of not less than 1.8 mm and a length of not less than 900 mm for pipe diameters of 150 mm or more and not less than 600 mm for pipe diameters of less than 150 mm (preferably equally divided to each side of the division). The pipe shall be connected to the ends of the sleeve by flanges or couplings; or the clearance between the sleeve and the pipe shall not exceed 2.5 mm; or any clearance between pipe and sleeve shall be made tight by means of non-combustible or other suitable material.

3.3 Uninsulated metallic pipes penetrating "A" or "B" class divisions shall be of materials having a melting temperature which exceeds 950°C for "A-0" and 850°C for "B-0" class divisions.

3.4 In approving structural fire protection details, the Administration shall have regard to the risk of heat transmission at intersections and terminal points of required thermal barriers. The insulation of a deck or bulkhead shall be carried past the penetration, intersection or terminal point for a distance of at least 450 mm in the case of steel and aluminium structures. If a space is divided with a deck or a bulkhead of "A" class standard having insulation of different values, the insulation with the higher value shall continue on the deck or bulkhead with the insulation of the lesser value for a distance of at least 450 mm.

4 Protection of openings in fire-resisting divisions

4.1 Openings in bulkheads and decks in passenger ships

4.1.1 Openings in "A" class divisions

4.1.1.1 Except for hatches between cargo, special category, store, and baggage spaces, and between such spaces and the weather decks, openings shall be provided with permanently attached means of closing which shall be at least as effective for resisting fires as the divisions in which they are fitted.

4.1.1.2 The construction of doors and door frames in “A” class divisions, with the means of securing them when closed, shall provide resistance to fire as well as to the passage of smoke and flame equivalent to that of the bulkheads in which the doors are situated, this being determined in accordance with the Fire Test Procedures Code. Such doors and door frames shall be constructed of steel or other equivalent material. Doors approved without the sill being part of the frame, which are installed on or after 1 July 2010, shall be installed such that the gap under the door does not exceed 12 mm. A non-combustible sill shall be installed under the door such that floor coverings do not extend beneath the closed door.

4.1.1.3 Watertight doors need not be insulated.

4.1.1.4 It shall be possible for each door to be opened and closed from each side of the bulkhead by one person only.

4.1.1.5 Fire doors in main vertical zone bulkheads, galley boundaries and stairway enclosures other than power-operated watertight doors and those which are normally locked shall satisfy the following requirements:

- .1 the doors shall be self-closing and be capable of closing with an angle of inclination of up to 3.5° opposing closure;
- .2 the approximate time of closure for hinged fire doors shall be no more than 40 s and no less than 10 s from the beginning of their movement with the ship in upright position. The approximate uniform rate of closure for sliding doors shall be of no more than 0.2 m/s and no less than 0.1 m/s with the ship in upright position;
- .3 the doors, except those for emergency escape trunks, shall be capable of remote release from the continuously manned central control station, either simultaneously or in groups, and shall be capable of release also individually from a position at both sides of the door. Release switches shall have an on-off function to prevent automatic resetting of the system;
- .4 hold-back hooks not subject to central control station release are prohibited;
- .5 a door closed remotely from the central control station shall be capable of being re-opened from both sides of the door by local control. After such local opening, the door shall automatically close again;
- .6 indication shall be provided at the fire door indicator panel in the continuously manned central control station whether each door is closed;
- .7 the release mechanism shall be so designed that the door will automatically close in the event of disruption of the control system or central power supply;
- .8 local power accumulators for power-operated doors shall be provided in the immediate vicinity of the doors to enable the doors to be operated at least 10 times (fully opened and closed) after disruption of the control system or central power supply using the local controls;
- .9 disruption of the control system or central power supply at one door shall not impair the safe functioning of the other doors;
- .10 remote-released sliding or power-operated doors shall be equipped with an alarm that sounds at least 5 s but no more than 10 s, after the door is released from the central control station and before the door begins to move and continues sounding until the door is completely closed;
- .11 a door designed to re-open upon contacting an object in its path shall re-open not more than 1 m from the point of contact;
- .12 double-leaf doors equipped with a latch necessary for their fire integrity shall have a latch that is automatically activated by the operation of the doors when released by the system;
- .13 doors giving direct access to special category spaces which are power-operated and automatically closed need not be equipped with the alarms and remote-release mechanisms required in paragraphs 4.1.1.5.3 and 4.1.1.5.10;
- .14 the components of the local control system shall be accessible for maintenance and adjusting;

- .15** power-operated doors shall be provided with a control system of an approved type which shall be able to operate in case of fire and be in accordance with the Fire Test Procedures Code. This system shall satisfy the following requirements:
- .1** the control system shall be able to operate the door at the temperature of at least 200°C for at least 60 min, served by the power supply;
 - .2** the power supply for all other doors not subject to fire shall not be impaired; and
 - .3** at temperatures exceeding 200°C, the control system shall be automatically isolated from the power supply and shall be capable of keeping the door closed up to at least 945°C.

4.1.1.6 In ships carrying not more than 36 passengers, where a space is protected by an automatic sprinkler fire detection and fire alarm system complying with the provisions of the Fire Safety Systems Code or fitted with a continuous "B" class ceiling, openings in decks not forming steps in main vertical zones nor bounding horizontal zones shall be closed reasonably tight and such decks shall meet the "A" class integrity requirements in so far as is reasonable and practicable in the opinion of the Administration.

4.1.1.7 The requirements for "A" class integrity of the outer boundaries of a ship shall not apply to glass partitions, windows and sidescuttles, provided that there is no requirement for such boundaries to have "A" class integrity in paragraph 4.1.3.3. The requirements for "A" class integrity of the outer boundaries of the ship shall not apply to exterior doors, except for those in superstructures and deckhouses facing life-saving appliances, embarkation and external assembly station areas, external stairs and open decks used for escape routes. Stairway enclosure doors need not meet this requirement.

4.1.1.8 Except for watertight doors, weathertight doors (semi-watertight doors), doors leading to the open deck and doors which need to be reasonably gastight, all "A" class doors located in stairways, public spaces and main vertical zone bulkheads in escape routes shall be equipped with a self-closing hose port. The material, construction and fire resistance of the hose port shall be equivalent to the door into which it is fitted, and shall be a 150 mm square clear opening with the door closed and shall be inset into the lower edge of the door, opposite the door hinges or, in the case of sliding doors, nearest the opening.

4.1.1.9 Where it is necessary that a ventilation duct passes through a main vertical zone division, a fail-safe automatic closing fire damper shall be fitted adjacent to the division. The damper shall also be capable of being manually closed from each side of the division. The operating position shall be readily accessible and be marked in red light-reflecting colour. The duct between the division and the damper shall be of steel or other equivalent material and, if necessary, insulated to comply with the requirements of paragraph 3.1. The damper shall be fitted on at least one side of the division with a visible indicator showing whether the damper is in the open position.

4.1.2 *Openings in "B" class divisions*

4.1.2.1 Doors and door frames in "B" class divisions and means of securing them shall provide a method of closure which shall have resistance to fire equivalent to that of the divisions, this being determined in accordance with the Fire Test Procedures Code except that ventilation openings may be permitted in the lower portion of such doors. Where such opening is in or under a door, the total net area of any such opening or openings shall not exceed 0.05 m². Alternatively, a non-combustible air balance duct routed between the cabin and the corridor, and located below the sanitary unit, is permitted where the cross-sectional area of the duct does not exceed 0.05 m². All ventilation openings shall be fitted with a grill made of non-combustible material. Doors shall be non-combustible. Doors approved without the sill being part of the frame, which are installed on or after 1 July 2010, shall be installed such that the gap under the door does not exceed 25 mm.

4.1.2.2 Cabin doors in "B" class divisions shall be of a self-closing type. Hold-back hooks are not permitted.

4.1.2.3 The requirements for "B" class integrity of the outer boundaries of a ship shall not apply to glass partitions, windows and sidescuttles. Similarly, the requirements for "B" class integrity shall not apply to exterior doors in superstructures and deckhouses. For ships carrying not more than 36 passengers, the Administration may permit the use of combustible materials in doors separating cabins from the individual interior sanitary spaces such as showers.

II-2

4.1.2.4 In ships carrying not more than 36 passengers, where an automatic sprinkler system complying with the provisions of the Fire Safety Systems Code is fitted:

- .1 openings in decks not forming steps in main vertical zones nor bounding horizontal zones shall be closed reasonably tight and such decks shall meet the "B" class integrity requirements in so far as is reasonable and practicable in the opinion of the Administration; and
- .2 openings in corridor bulkheads of "B" class materials shall be protected in accordance with the provisions of paragraph 2.2.2.

4.1.3 Windows and sidescuttles

4.1.3.1 Windows and sidescuttles in bulkheads within accommodation and service spaces and control stations other than those to which the provisions of paragraphs 4.1.1.6 and 4.1.2.3 apply shall be so constructed as to preserve the integrity requirements of the type of bulkheads in which they are fitted, this being determined in accordance with the Fire Test Procedures Code.

4.1.3.2 Notwithstanding the requirements of tables 9.1 to 9.4, windows and sidescuttles in bulkheads separating accommodation and service spaces and control stations from weather shall be constructed with frames of steel or other suitable material. The glass shall be retained by a metal glazing bead or angle.

4.1.3.3 Windows facing life-saving appliances, embarkation and assembly stations, external stairs and open decks used for escape routes, and windows situated below liferaft and escape slide embarkation areas shall have fire integrity as required in table 9.1. Where automatic dedicated sprinkler heads are provided for windows, "A-0" windows may be accepted as equivalent. To be considered under this paragraph, the sprinkler heads shall either be:

- .1 dedicated heads located above the windows, and installed in addition to the conventional ceiling sprinklers; or
- .2 conventional ceiling sprinkler heads arranged such that the window is protected by an average application rate of at least 5 L/min/m² and the additional window area is included in the calculation of the area of coverage; or
- .3 water-mist nozzles that have been tested and approved in accordance with the guidelines approved by the Organization.*

Windows located in the ship's side below the lifeboat embarkation area shall have fire integrity at least equal to "A-0" class.

4.1.3.4 Notwithstanding the requirement in paragraph 4.1.3.3, the requirements in paragraphs 4.1.3.5 and 4.1.3.6 shall apply to ships constructed on or after 1 January 2020.

4.1.3.5 For ships carrying more than 36 passengers, windows facing survival craft, embarkation and assembly stations, external stairs and open decks used for escape routes, and windows situated below liferaft and escape slide embarkation areas shall have fire integrity as required in table 9.1. Where automatic dedicated sprinkler heads are provided for windows, "A-0" windows may be accepted as equivalent. To be considered under this paragraph, the sprinkler heads must either be:

- .1 dedicated heads located above the windows, and installed in addition to the conventional ceiling sprinklers; or
- .2 conventional ceiling sprinkler heads arranged such that the window is protected by an average application rate of at least 5 L/min/m² and the additional window area is included in the calculation of the area of coverage; or

* Refer to *Revised guidelines for approval of sprinkler systems equivalent to that referred to in SOLAS regulation II-2/12* (resolution A.800(19), as amended).

- .3 water-mist nozzles that have been tested and approved in accordance with the guidelines approved by the Organization;* and

windows located in the ship's side below the lifeboat embarkation area shall have fire integrity at least equal to "A-0" class.

4.1.3.6 For ships carrying not more than 36 passengers, windows facing survival craft and escape slide, embarkation areas and windows situated below such areas shall have fire integrity at least equal to "A-0" class.

4.2 Doors in fire-resisting divisions in cargo ships

4.2.1 The fire resistance of doors shall be equivalent to that of the division in which they are fitted, this being determined in accordance with the Fire Test Procedures Code. Doors approved as "A" class without the sill being part of the frame, which are installed on or after 1 July 2010, shall be installed such that the gap under the door does not exceed 12 mm and a non-combustible sill shall be installed under the door such that floor coverings do not extend beneath the closed door. Doors approved as "B" class without the sill being part of the frame, which are installed on or after 1 July 2010, shall be installed such that the gap under the door does not exceed 25 mm. Doors and door frames in "A" class divisions shall be constructed of steel. Doors in "B" class divisions shall be non-combustible. Doors fitted in boundary bulkheads of machinery spaces of category A shall be reasonably gastight and self-closing. In ships constructed according to method IC, the Administration may permit the use of combustible materials in doors separating cabins from individual interior sanitary accommodation such as showers.

4.2.2 Doors required to be self-closing shall not be fitted with hold-back hooks. However, hold-back arrangements fitted with remote release devices of the fail-safe type may be utilized.

4.2.3 In corridor bulkheads, ventilation openings may be permitted in and under the doors of cabins and public spaces. Ventilation openings are also permitted in "B" class doors leading to lavatories, offices, pantries, lockers and store-rooms. Except as permitted below, the openings shall be provided only in the lower half of a door. Where such an opening is in or under a door, the total net area of any such opening or openings shall not exceed 0.05 m². Alternatively, a non-combustible air balance duct routed between the cabin and the corridor, and located below the sanitary unit, is permitted where the cross-sectional area of the duct does not exceed 0.05 m². Ventilation openings, except those under the door, shall be fitted with a grill made of non-combustible material.

4.2.4 Watertight doors need not be insulated.

5 Protection of openings in machinery space boundaries

5.1 Application

5.1.1 The provision of this paragraph shall apply to machinery spaces of category A and, where the Administration considers it desirable, to other machinery spaces.

5.2 Protection of openings in machinery space boundaries

5.2.1 The number of skylights, doors, ventilators, openings in funnels to permit exhaust ventilation and other openings to machinery spaces shall be reduced to a minimum consistent with the needs of ventilation and the proper and safe working of the ship.

5.2.2 Skylights shall be of steel and shall not contain glass panels.

5.2.3 Means of control shall be provided for closing power-operated doors or actuating release mechanisms on doors other than power-operated watertight doors. The controls shall be located outside the space concerned, where they will not be cut off in the event of fire in the space it serves.

* Refer to the *Revised guidelines for approval of sprinkler systems equivalent to that referred to in SOLAS regulation II-2/12* (resolution A.800(19), as amended).

5.2.4 In passenger ships, the means of control required in paragraph 5.2.3 shall be situated at one control position or grouped in as few positions as possible, to the satisfaction of the Administration. Such positions shall have safe access from the open deck.

5.2.5 In passenger ships, doors, other than power-operated watertight doors, shall be so arranged that positive closure is assured in case of fire in the space by power-operated closing arrangements or by the provision of self-closing doors capable of closing against an inclination of 3.5° opposing closure, and having a fail-safe hold-back arrangement, provided with a remotely operated release device. Doors for emergency escape trunks need not be fitted with a fail-safe hold-back facility and a remotely operated release device.

5.2.6 Windows shall not be fitted in machinery space boundaries. However, this does not preclude the use of glass in control rooms within the machinery spaces.

6 Protection of cargo space boundaries

6.1 In passenger ships carrying more than 36 passengers, the boundary bulkheads and decks of special category and ro-ro spaces shall be insulated to "A-60" class standard. However, where a category (5), (9) or (10) space, as defined in paragraph 2.2.3, is on one side of the division, the standard may be reduced to "A-0". Where fuel oil tanks are below a special category space, the integrity of the deck between such spaces may be reduced to "A-0" standard.

6.2 In passenger ships, indicators shall be provided on the navigation bridge which shall indicate when any fire door leading to or from the special category spaces is closed.

6.3 In tankers, for the protection of cargo tanks carrying crude oil and petroleum products having a flashpoint not exceeding 60°C, materials readily rendered ineffective by heat shall not be used for valves, fittings, tank opening covers, cargo vent piping and cargo piping so as to prevent the spread of fire to the cargo.

7 Ventilation systems

(This paragraph applies to ships constructed on or after 1 January 2016)

7.1 General

7.1.1 Ventilation ducts, including single and double wall ducts, shall be of steel or equivalent material except flexible bellows of short length not exceeding 600 mm used for connecting fans to the ducting in air-conditioning rooms. Unless expressly provided otherwise in paragraph 7.1.6, any other material used in the construction of ducts, including insulation, shall also be non-combustible. However, short ducts, not generally exceeding 2 m in length and with a free cross-sectional area* not exceeding 0.02 m², need not be of steel or equivalent material, subject to the following conditions:

SEE INTERPRETATION 18

- .1 the ducts shall be made of non-combustible material, which may be faced internally and externally with membranes having low flame-spread characteristics and, in each case, a calorific value[†] not exceeding 45 MJ/m² of their surface area for the thickness used;
- .2 the ducts are only used at the end of the ventilation device; and
- .3 the ducts are not situated less than 600 mm, measured along the duct, from an opening in an "A" or "B" class division, including continuous "B" class ceiling.

* The term *free cross-sectional area* means, even in the case of a pre-insulated duct, the area calculated on the basis of the inner dimensions of the duct itself and not the insulation.

[†] Refer to the recommendations published by the International Organization for Standardization, in particular publication ISO 1716:2002, *Reaction to fire tests for building products – Determination of the heat of combustion*.

7.1.2 The following arrangements shall be tested in accordance with the Fire Test Procedures Code:

- .1** fire dampers, including their relevant means of operation, however, the testing is not required for dampers located at the lower end of the duct in exhaust ducts for galley ranges, which must be of steel and capable of stopping the draught in the duct; and
- .2** duct penetrations through "A" class divisions. However, the test is not required where steel sleeves are directly joined to ventilation ducts by means of riveted or screwed connections or by welding.

7.1.3 Fire dampers shall be easily accessible. Where they are placed behind ceilings or linings, these ceilings or linings shall be provided with an inspection hatch on which the identification number of the fire damper is marked. The fire damper identification number shall also be marked on any remote controls provided.

7.1.4 Ventilation ducts shall be provided with hatches for inspection and cleaning. The hatches shall be located near the fire dampers.

7.1.5 The main inlets and outlets of ventilation systems shall be capable of being closed from outside the spaces being ventilated. The means of closing shall be easily accessible as well as prominently and permanently marked and shall indicate the operating position of the closing device.

7.1.6 Combustible gaskets in flanged ventilation duct connections are not permitted within 600 mm of openings in "A" or "B" class divisions and in ducts required to be of "A" class construction.

7.1.7 Ventilation openings or air balance ducts between two enclosed spaces shall not be provided except as permitted by paragraphs 4.1.2.1 and 4.2.3.

7.2 Arrangement of ducts

7.2.1 The ventilation systems for machinery spaces of category A, vehicle spaces, ro-ro spaces, galleys, special category spaces and cargo spaces shall, in general, be separated from each other and from the ventilation systems serving other spaces. However, the galley ventilation systems on cargo ships of less than 4,000 gross tonnage and in passenger ships carrying not more than 36 passengers need not be completely separated from other ventilation systems, but may be served by separate ducts from a ventilation unit serving other spaces. In such a case, an automatic fire damper shall be fitted in the galley ventilation duct near the ventilation unit.

7.2.2 Ducts provided for the ventilation of machinery spaces of category A, galleys, vehicle spaces, ro-ro spaces or special category spaces shall not pass through accommodation spaces, service spaces, or control stations unless they comply with paragraph 7.2.4.

7.2.3 Ducts provided for the ventilation of accommodation spaces, service spaces or control stations shall not pass through machinery spaces of category A, galleys, vehicle spaces, ro-ro spaces or special category spaces unless they comply with paragraph 7.2.4.

7.2.4 As permitted by paragraphs 7.2.2 and 7.2.3 ducts shall be either:

- .1.1** constructed of steel having a thickness of at least 3 mm for ducts with a free cross-sectional area of less than 0.075 m², at least 4 mm for ducts with a free cross-sectional area of between 0.075 m² and 0.45 m², and at least 5 mm for ducts with a free cross-sectional area of over 0.45 m²;
- .1.2** suitably supported and stiffened;
- .1.3** fitted with automatic fire dampers close to the boundaries penetrated; and
- .1.4** insulated to "A-60" class standard from the boundaries of the spaces they serve to a point at least 5 m beyond each fire damper;

or

- .2.1** constructed of steel in accordance with paragraphs 7.2.4.1.1 and 7.2.4.1.2; and
- .2.2** insulated to "A-60" class standard throughout the spaces they pass through, except for ducts that pass through spaces of category (9) or (10) as defined in paragraph 2.2.3.2.2.

7.2.5 For the purposes of paragraphs 7.2.4.1.4 and 7.2.4.2.2, ducts shall be insulated over their entire cross-sectional external surface. Ducts that are outside but adjacent to the specified space, and share one or more surfaces with it, shall be considered to pass through the specified space, and shall be insulated over the surface they share with the space for a distance of 450 mm past the duct.*

7.2.6 Where it is necessary that a ventilation duct passes through a main vertical zone division, an automatic fire damper shall be fitted adjacent to the division. The damper shall also be capable of being manually closed from each side of the division. The control location shall be readily accessible and be clearly and prominently marked. The duct between the division and the damper shall be constructed of steel in accordance with paragraphs 7.2.4.1.1 and 7.2.4.1.2 and insulated to at least the same fire integrity as the division penetrated. The damper shall be fitted on at least one side of the division with a visible indicator showing the operating position of the damper.

7.3 Details of fire dampers and duct penetrations

7.3.1 Ducts passing through "A" class divisions shall meet the following requirements:

- .1** where a thin plated duct with a free cross-sectional area equal to, or less than, 0.02 m² passes through "A" class divisions, the opening shall be fitted with a steel sheet sleeve having a thickness of at least 3 mm and a length of at least 200 mm, divided preferably into 100 mm on each side of a bulkhead or, in the case of a deck, wholly laid on the lower side of the decks penetrated;
- .2** where ventilation ducts with a free cross-sectional area exceeding 0.02 m², but not more than 0.075 m², pass through "A" class divisions, the openings shall be lined with steel sheet sleeves. The ducts and sleeves shall have a thickness of at least 3 mm and a length of at least 900 mm. When passing through bulkheads, this length shall be divided preferably into 450 mm on each side of the bulkhead. These ducts, or sleeves lining such ducts, shall be provided with fire insulation. The insulation shall have at least the same fire integrity as the division through which the duct passes; and
- .3** automatic fire dampers shall be fitted in all ducts with a free cross-sectional area exceeding 0.075 m² that pass through "A" class divisions. Each damper shall be fitted close to the division penetrated and the duct between the damper and the division penetrated shall be constructed of steel in accordance with paragraphs 7.2.4.2.1 and 7.2.4.2.2. The fire damper shall operate automatically, but shall also be capable of being closed manually from both sides of the division. The damper shall be fitted with a visible indicator which shows the operating position of the damper. Fire dampers are not required, however, where ducts pass through spaces surrounded by "A" class divisions, without serving those spaces, provided those ducts have the same fire integrity as the divisions which they penetrate. A duct of cross-sectional area exceeding 0.075 m² shall not be divided into smaller ducts at the penetration of an "A" class division and then recombined into the original duct once through the division to avoid installing the damper required by this provision.

7.3.2 Ventilation ducts with a free cross-sectional area exceeding 0.02 m² passing through "B" class bulkheads shall be lined with steel sheet sleeves of 900 mm in length, divided preferably into 450 mm on each side of the bulkheads unless the duct is of steel for this length.

7.3.3 All fire dampers shall be capable of manual operation. The dampers shall have a direct mechanical means of release or, alternatively, be closed by electrical, hydraulic, or pneumatic operation. All dampers shall be manually operable from both sides of the division. Automatic fire dampers, including those capable of remote operation, shall have a failsafe mechanism that will close the damper in a fire even upon loss of electrical power or hydraulic or pneumatic pressure loss. Remotely operated fire dampers shall be capable of being reopened manually at the damper.

* Sketches of such arrangements are contained in the *Unified Interpretations of SOLAS chapter II-2 (MSC.1/Circ.1276)*.

7.4 Ventilation systems for passenger ships carrying more than 36 passengers

7.4.1 In addition to the requirements in sections 7.1, 7.2 and 7.3, the ventilation system of a passenger ship carrying more than 36 passengers shall also meet the following requirements.

7.4.2 In general, the ventilation fans shall be so arranged that the ducts reaching the various spaces remain within a main vertical zone.

7.4.3 Stairway enclosures shall be served by an independent ventilation fan and duct system (exhaust and supply) which shall not serve any other spaces in the ventilation systems.

7.4.4 A duct, irrespective of its cross-section, serving more than one 'tween-deck accommodation space, service space or control station, shall be fitted, near the penetration of each deck of such spaces, with an automatic smoke damper that shall also be capable of being closed manually from the protected deck above the damper. Where a fan serves more than one 'tween-deck space through separate ducts within a main vertical zone, each dedicated to a single 'tween-deck space, each duct shall be provided with a manually operated smoke damper fitted close to the fan.

7.4.5 Vertical ducts shall, if necessary, be insulated as required by tables 9.1 and 9.2. Ducts shall be insulated as required for decks between the space they serve and the space being considered, as applicable.

7.5 Exhaust ducts from galley ranges

SEE INTERPRETATION 19

7.5.1 Requirements for passenger ships carrying more than 36 passengers

7.5.1.1 In addition to the requirements in sections 7.1, 7.2 and 7.3, exhaust ducts from galley ranges shall be constructed in accordance with paragraphs 7.2.4.2.1 and 7.2.4.2.2 and insulated to "A-60" class standard throughout accommodation spaces, service spaces, or control stations they pass through. They shall also be fitted with:

- .1 a grease trap readily removable for cleaning unless an alternative approved grease removal system is fitted;
- .2 a fire damper located in the lower end of the duct at the junction between the duct and the galley range hood which is automatically and remotely operated and, in addition, a remotely operated fire damper located in the upper end of the duct close to the outlet of the duct;
- .3 a fixed means for extinguishing a fire within the duct;*
- .4 remote-control arrangements for shutting off the exhaust fans and supply fans, for operating the fire dampers mentioned in paragraph 7.5.1.1.2 and for operating the fire-extinguishing system, which shall be placed in a position outside the galley close to the entrance to the galley. Where a multi-branch system is installed, a remote means located with the above controls shall be provided to close all branches exhausting through the same main duct before an extinguishing medium is released into the system; and
- .5 suitably located hatches for inspection and cleaning, including one provided close to the exhaust fan and one fitted in the lower end where grease accumulates.

7.5.1.2 Exhaust ducts from ranges for cooking equipment installed on open decks shall conform to paragraph 7.5.1.1, as applicable, when passing through accommodation spaces or spaces containing combustible materials.

* Refer to the recommendations published by the International Organization for Standardization, in particular, publication ISO 15371:2009, *Ships and marine technology – Fire-extinguishing systems for protection of galley cooking equipment*.

7.5.2 Requirements for cargo ships and passenger ships carrying not more than 36 passengers

When passing through accommodation spaces or spaces containing combustible materials, the exhaust ducts from galley ranges shall be constructed in accordance with paragraphs 7.2.4.1.1 and 7.2.4.1.2. Each exhaust duct shall be fitted with:

- .1 a grease trap readily removable for cleaning;
- .2 an automatically and remotely operated fire damper located in the lower end of the duct at the junction between the duct and the galley range hood and, in addition, a remotely operated fire damper in the upper end of the duct close to the outlet of the duct;
- .3 arrangements, operable from within the galley, for shutting off the exhaust and supply fans; and
- .4 fixed means for extinguishing a fire within the duct.*

7.6 Ventilation rooms serving machinery spaces of category A containing internal combustion machinery

7.6.1 Where a ventilation room serves only such an adjacent machinery space and there is no fire division between the ventilation room and the machinery space, the means for closing the ventilation duct or ducts serving the machinery space shall be located outside of the ventilation room and machinery space.

7.6.2 Where a ventilation room serves such a machinery space as well as other spaces and is separated from the machinery space by an "A-0" class division, including penetrations, the means for closing the ventilation duct or ducts for the machinery space can be located in the ventilation room.

7.7 Ventilation systems for laundries in passenger ships carrying more than 36 passengers

Exhaust ducts from laundries and drying rooms of category (13) spaces as defined in paragraph 2.2.3.2.2 shall be fitted with:

- .1 filters readily removable for cleaning purposes;
- .2 a fire damper located in the lower end of the duct which is automatically and remotely operated;
- .3 remote-control arrangements for shutting off the exhaust fans and supply fans from within the space and for operating the fire damper mentioned in paragraph 7.7.2; and
- .4 suitably located hatches for inspection and cleaning.

Regulation 10

Fire fighting

1 Purpose

1.1 The purpose of this regulation is to suppress and swiftly extinguish a fire in the space of origin, except for paragraph 1.2. For this purpose, the following functional requirements shall be met:

- .1 fixed fire-extinguishing systems shall be installed having due regard to the fire growth potential of the protected spaces; and
- .2 fire-extinguishing appliances shall be readily available.

* Refer to the recommendations published by the International Organization for Standardization, in particular, publication ISO 15371:2009, *Ships and marine technology – Fire-extinguishing systems for protection of galley cooking equipment*.

1.2 For open-top container holds* and on deck container stowage areas on ships designed to carry containers on or above the weather deck, constructed on or after 1 January 2016, fire protection arrangements shall be provided for the purpose of containing a fire in the space or area of origin and cooling adjacent areas to prevent fire spread and structural damage.

2 Water supply systems

Ships shall be provided with fire pumps, fire mains, hydrants and hoses complying with the applicable requirements of this regulation.

2.1 Fire mains and hydrants

2.1.1 General

Materials readily rendered ineffective by heat shall not be used for fire mains and hydrants unless adequately protected. The pipes and hydrants shall be so placed that the fire hoses may be easily coupled to them. The arrangement of pipes and hydrants shall be such as to avoid the possibility of freezing. Suitable drainage provisions shall be provided for fire main piping. Isolation valves shall be installed for all open deck fire main branches used for purposes other than fire fighting. In ships where deck cargo may be carried, the positions of the hydrants shall be such that they are always readily accessible and the pipes shall be arranged as far as practicable to avoid risk of damage by such cargo.

2.1.2 Ready availability of water supply

The arrangements for the ready availability of water supply shall be:

- .1** in passenger ships:
 - .1** of 1,000 gross tonnage and upwards such that at least one effective jet of water is immediately available from any hydrant in an interior location and so as to ensure the continuation of the output of water by the automatic starting of one required fire pump;
 - .2** of less than 1,000 gross tonnage by automatic start of at least one fire pump or by remote starting from the navigation bridge of at least one fire pump. If the pump starts automatically or if the bottom valve cannot be opened from where the pump is remotely started, the bottom valve shall always be kept open; and
 - .3** if fitted with periodically unattended machinery spaces in accordance with regulation II-1/54, the Administration shall determine provisions for fixed water fire-extinguishing arrangements for such spaces equivalent to those required for normally attended machinery spaces;
- .2** in cargo ships:
 - .1** to the satisfaction of the Administration; and
 - .2** with a periodically unattended machinery space or when only one person is required on watch, there shall be immediate water delivery from the fire main system at a suitable pressure, either by remote starting of one of the main fire pumps with remote starting from the navigation bridge and fire control station, if any, or permanent pressurization of the fire main system by one of the main fire pumps, except that the Administration may waive this requirement for cargo ships of less than 1,600 gross tonnage if the fire pump starting arrangement in the machinery space is in an easily accessible position.

2.1.3 Diameter of fire mains

The diameter of the fire main and water service pipes shall be sufficient for the effective distribution of the maximum required discharge from two fire pumps operating simultaneously, except that in the case of cargo

* For a definition of this term, refer to *Interim guidelines for open-top containerships* (MSC/Circ.608/Rev.1).

ships, other than those included in paragraph 7.3.2, the diameter need only be sufficient for the discharge of 140 m³/h.

SEE INTERPRETATION 20

2.1.4 Isolating valves and relief valves

2.1.4.1 Isolating valves to separate the section of the fire main within the machinery space containing the main fire pump or pumps from the rest of the fire main shall be fitted in an easily accessible and tenable position outside the machinery spaces. The fire main shall be so arranged that when the isolating valves are shut all the hydrants on the ship, except those in the machinery space referred to above, can be supplied with water by another fire pump or an emergency fire pump. The emergency fire pump, its seawater inlet, and suction and delivery pipes and isolating valves shall be located outside the machinery space. If this arrangement cannot be made, the sea-chest may be fitted in the machinery space if the valve is remotely controlled from a position in the same compartment as the emergency fire pump and the suction pipe is as short as practicable. Short lengths of suction or discharge piping may penetrate the machinery space, provided they are enclosed in a substantial steel casing or are insulated to "A-60" class standards. The pipes shall have substantial wall thickness, but in no case less than 11 mm, and shall be welded except for the flanged connection to the sea inlet valve.

SEE INTERPRETATION 21

2.1.4.2 A valve shall be fitted to serve each fire hydrant so that any fire hose may be removed while the fire pumps are in operation.

2.1.4.3 Relief valves shall be provided in conjunction with fire pumps if the pumps are capable of developing a pressure exceeding the design pressure of the water service pipes, hydrants and hoses. These valves shall be so placed and adjusted as to prevent excessive pressure in any part of the fire main system.

2.1.4.4 In tankers, isolation valves shall be fitted in the fire main at the poop front in a protected position and on the tank deck at intervals of not more than 40 m to preserve the integrity of the fire main system in case of fire or explosion.

SEE INTERPRETATION 22

2.1.5 Number and position of hydrants

2.1.5.1 The number and position of hydrants shall be such that at least two jets of water not emanating from the same hydrant, one of which shall be from a single length of hose, may reach any part of the ship normally accessible to the passengers or crew while the ship is being navigated and any part of any cargo space when empty, any ro-ro space or any vehicle space, in which latter case the two jets shall reach any part of the space, each from a single length of hose. Furthermore, such hydrants shall be positioned near the accesses to the protected spaces.

2.1.5.2 In addition to the requirements in paragraph 2.1.5.1, passenger ships shall comply with the following:

- .1** in the accommodation, service and machinery spaces, the number and position of hydrants shall be such that the requirements of paragraph 2.1.5.1 may be complied with when all watertight doors and all doors in main vertical zone bulkheads are closed; and
- .2** where access is provided to a machinery space of category A at a low level from an adjacent shaft tunnel, two hydrants shall be provided external to, but near the entrance to, that machinery space. Where such access is provided from other spaces, in one of those spaces two hydrants shall be provided near the entrance to the machinery space of category A. Such provision need not be made where the tunnel or adjacent spaces are not part of the escape route.

2.1.6 Pressure at hydrants

With the two pumps simultaneously delivering water through the nozzles specified in paragraph 2.3.3, with the quantity of water as specified in paragraph 2.1.3, through any adjacent hydrants, the following minimum pressures shall be maintained at all hydrants:

- .1 for passenger ships:

4,000 gross tonnage and upwards	0.40 N/mm ²
less than 4,000 gross tonnage	0.30 N/mm ²
- .2 for cargo ships:

6,000 gross tonnage and upwards	0.27 N/mm ²
less than 6,000 gross tonnage	0.25 N/mm ²

and
- .3 the maximum pressure at any hydrant shall not exceed that at which the effective control of a fire hose can be demonstrated.

2.1.7 International shore connection

2.1.7.1 Ships of 500 gross tonnage and upwards shall be provided with at least one international shore connection complying with the Fire Safety Systems Code.

2.1.7.2 Facilities shall be available enabling such a connection to be used on either side of the ship.

2.2 Fire pumps

2.2.1 Pumps accepted as fire pumps

Sanitary, ballast, bilge or general service pumps may be accepted as fire pumps, provided that they are not normally used for pumping oil and that if they are subject to occasional duty for the transfer or pumping of oil fuel, suitable change-over arrangements are fitted.

2.2.2 Number of fire pumps

Ships shall be provided with independently driven fire pumps as follows:

- .1 in passenger ships of:

4,000 gross tonnage and upwards	at least three
less than 4,000 gross tonnage	at least two
- .2 in cargo ships of:

1,000 gross tonnage and upwards	at least two
less than 1,000 gross tonnage	at least two power-driven pumps, one of which shall be independently driven

2.2.3 Arrangement of fire pumps and fire mains

2.2.3.1 Fire pumps

The arrangement of sea connections, fire pumps and their sources of power shall be as to ensure that:

- .1 in passenger ships of 1,000 gross tonnage and upwards, in the event of a fire in any one compartment, all the fire pumps will not be put out of action; and
- .2 in passenger ships of less than 1,000 gross tonnage and in cargo ships, if a fire in any one compartment could put all the pumps out of action, there shall be an alternative means consisting of an emergency fire pump complying with the provisions of the Fire Safety Systems Code with its source of power and sea connection located outside the space where the main fire pumps or their sources of power are located.

2.2.3.2 Requirements for the space containing the emergency fire pump

2.2.3.2.1 Location of the space

The space containing the fire pump shall not be contiguous to the boundaries of machinery spaces of category A or those spaces containing main fire pumps. Where this is not practicable, the common bulkhead between the two spaces shall be insulated to a standard of structural fire protection equivalent to that required for a control station.

2.2.3.2.2 Access to the emergency fire pump

No direct access shall be permitted between the machinery space and the space containing the emergency fire pump and its source of power. When this is impracticable, the Administration may accept an arrangement where the access is by means of an airlock with the door of the machinery space being of "A-60" class standard and the other door being at least steel, both reasonably gastight, self-closing and without any hold-back arrangements. Alternatively, the access may be through a watertight door capable of being operated from a space remote from the machinery space and the space containing the emergency fire pump and unlikely to be cut off in the event of fire in those spaces. In such cases, a second means of access to the space containing the emergency fire pump and its source of power shall be provided.

2.2.3.2.3 Ventilation of the emergency fire pump space

Ventilation arrangements to the space containing the independent source of power for the emergency fire pump shall be such as to preclude, as far as practicable, the possibility of smoke from a machinery space fire entering or being drawn into that space.

2.2.3.3 Additional pumps for cargo ships

In addition, in cargo ships where other pumps, such as general service, bilge and ballast, etc., are fitted in a machinery space, arrangements shall be made to ensure that at least one of these pumps, having the capacity and pressure required by paragraphs 2.1.6.2 and 2.2.4.2, is capable of providing water to the fire main.

2.2.4 Capacity of fire pumps

2.2.4.1 Total capacity of required fire pumps

The required fire pumps shall be capable of delivering for fire-fighting purposes a quantity of water, at the pressure specified in paragraph 2.1.6, as follows:

- .1 pumps in passenger ships: the quantity of water is not less than two thirds of the quantity required to be dealt with by the bilge pumps when employed for bilge pumping; and
- .2 pumps in cargo ships, other than any emergency pump: the quantity of water is not less than four thirds of the quantity required under regulation II-1/35-1 to be dealt with by each of the independent bilge pumps in a passenger ship of the same dimension when employed in bilge pumping, provided that in no cargo ship, other than those included in paragraph 7.3.2, need the total required capacity of the fire pumps exceed 180 m³/h.

SEE INTERPRETATION 20

2.2.4.2 Capacity of each fire pump

Each of the required fire pumps (other than any emergency pump required in paragraph 2.2.3.1.2 for cargo ships) shall have a capacity not less than 80% of the total required capacity divided by the minimum number of required fire pumps, but in any case not less than 25 m³/h, and each such pump shall in any event be capable of delivering at least the two required jets of water. These fire pumps shall be capable of supplying the fire main system under the required conditions. Where more pumps than the minimum of required pumps are installed, such additional pumps shall have a capacity of at least 25 m³/h and shall be capable of delivering at least the two jets of water required in paragraph 2.1.5.1.

2.3 Fire hoses and nozzles

2.3.1 General specifications

2.3.1.1 Fire hoses shall be of non-perishable material approved by the Administration and shall be sufficient in length to project a jet of water to any of the spaces in which they may be required to be used. Each hose shall be provided with a nozzle and the necessary couplings. Hoses specified in this chapter as "fire hoses" shall, together with any necessary fittings and tools, be kept ready for use in conspicuous positions near the water service hydrants or connections. Additionally, in interior locations in passenger ships carrying more than 36 passengers, fire hoses shall be connected to the hydrants at all times. Fire hoses shall have a length of at least 10 m, but not more than:

- .1 15 m in machinery spaces;
- .2 20 m in other spaces and open decks; and
- .3 25 m for open decks on ships with a maximum breadth in excess of 30 m.

2.3.1.2 Unless one hose and nozzle is provided for each hydrant in the ship, there shall be complete interchangeability of hose couplings and nozzles.

2.3.2 Number and diameter of fire hoses

2.3.2.1 Ships shall be provided with fire hoses, the number and diameter of which shall be to the satisfaction of the Administration.

2.3.2.2 In passenger ships, there shall be at least one fire hose for each of the hydrants required by paragraph 2.1.5 and these hoses shall be used only for the purposes of extinguishing fires or testing the fire-extinguishing apparatus at fire drills and surveys.

2.3.2.3 In cargo ships:

- .1 of 1,000 gross tonnage and upwards, the number of fire hoses to be provided shall be one for each 30 m length of the ship and one spare, but in no case less than five in all. This number does not include any hoses required in any engine-room or boiler room. The Administration may increase the number of hoses required so as to ensure that hoses in sufficient number are available and accessible at all times, having regard to the type of ship and the nature of trade in which the ship is employed. Ships carrying dangerous goods in accordance with regulation 19 shall be provided with three hoses and nozzles, in addition to those required above; and
- .2 of less than 1,000 gross tonnage, the number of fire hoses to be provided shall be calculated in accordance with the provisions of paragraph 2.3.2.3.1. However, the number of hoses shall in no case be less than three.

2.3.3 Size and types of nozzles

2.3.3.1 For the purposes of this chapter, standard nozzle sizes shall be 12 mm, 16 mm and 19 mm or as near thereto as possible. Larger diameter nozzles may be permitted at the discretion of the Administration.

2.3.3.2 For accommodation and service spaces, a nozzle size greater than 12 mm need not be used.

2.3.3.3 For machinery spaces and exterior locations, the nozzle size shall be such as to obtain the maximum discharge possible from two jets at the pressure mentioned in paragraph 2.1.6 from the smallest pump, provided that a nozzle size greater than 19 mm need not be used.

2.3.3.4 Nozzles shall be of an approved dual-purpose type (i.e. spray/jet type) incorporating a shutoff.

3 Portable fire extinguishers*

3.1 Type and design

Portable fire extinguishers shall comply with the requirements of the Fire Safety Systems Code.

3.2 Arrangement of fire extinguishers

3.2.1 Accommodation spaces, service spaces and control stations shall be provided with portable fire extinguishers of appropriate types and in sufficient number to the satisfaction of the Administration. Ships of 1,000 gross tonnage and upwards shall carry at least five portable fire extinguishers.

3.2.2 One of the portable fire extinguishers intended for use in any space shall be stowed near the entrance to that space.

3.2.3 Carbon dioxide fire extinguishers shall not be placed in accommodation spaces. In control stations and other spaces containing electrical or electronic equipment or appliances necessary for the safety of the ship, fire extinguishers shall be provided whose extinguishing media are neither electrically conductive nor harmful to the equipment and appliances.

3.2.4 Fire extinguishers shall be situated ready for use at easily visible places, which can be reached quickly and easily at any time in the event of a fire, and in such a way that their serviceability is not impaired by the weather, vibration or other external factors. Portable fire extinguishers shall be provided with devices which indicate whether they have been used.

3.3 Spare charges

3.3.1 Spare charges shall be provided for 100% of the first ten extinguishers and 50% of the remaining fire extinguishers capable of being recharged on board. Not more than 60 total spare charges are required. Instructions for recharging shall be carried on board.

3.3.2 For fire extinguishers which cannot be recharged on board, additional portable fire extinguishers of the same quantity, type, capacity and number as determined in paragraph 3.3.1 above shall be provided in lieu of spare charges.

4 Fixed fire-extinguishing systems

4.1 Types of fixed fire-extinguishing systems

4.1.1 A fixed fire-extinguishing system required by paragraph 5 below may be any of the following systems:

- .1 a fixed gas fire-extinguishing system complying with the provisions of the Fire Safety Systems Code;
- .2 a fixed high-expansion foam fire-extinguishing system complying with the provisions of the Fire Safety Systems Code; and
- .3 a fixed pressure water-spraying fire-extinguishing system complying with the provisions of the Fire Safety Systems Code.

4.1.2 Where a fixed fire-extinguishing system not required by this chapter is installed, it shall meet the requirements of the relevant regulations of this chapter and the Fire Safety Systems Code.

4.1.3 Fire-extinguishing systems using Halon 1211, 1301, and 2402 and perfluorocarbons shall be prohibited.†

* Refer to *Improved guidelines for marine portable fire extinguishers* (resolution A.951(23)) and *Unified interpretation of SOLAS chapter II-2 on the number and arrangement of portable fire extinguishers on board ships* (MSC.1/ Circ.1275 and Corr.1).

† The list of halon banking and reception facilities to recharge or decommission existing fire-extinguishing systems are circulated through the Global Integrated Shipping Information System (GISIS) (resolution A.1074(28)), under the module "Test Laboratories and Halon Facilities".

4.1.4 In general, the Administration shall not permit the use of steam as a fire-extinguishing medium in fixed fire-extinguishing systems. Where the use of steam is permitted by the Administration, it shall be used only in restricted areas as an addition to the required fire-extinguishing system and shall comply with the requirements of the Fire Safety System Code.

4.1.5 By the first scheduled dry-docking after 1 January 2010, fixed carbon dioxide fire-extinguishing systems for the protection of machinery spaces and cargo pump-rooms on ships constructed before 1 July 2002 shall comply with the provisions of paragraph 2.2.2 of chapter 5 of the Fire Safety Systems Code.

4.2 Closing appliances for fixed gas fire-extinguishing systems

Where a fixed gas fire-extinguishing system is used, openings which may admit air to, or allow gas to escape from, a protected space shall be capable of being closed from outside the protected space.

4.3 Storage rooms of fire-extinguishing medium

When the fire-extinguishing medium is stored outside a protected space, it shall be stored in a room which is located behind the forward collision bulkhead, and is used for no other purposes. Any entrance to such a storage room shall preferably be from the open deck and shall be independent of the protected space. If the storage space is located below deck, it shall be located no more than one deck below the open deck and shall be directly accessible by a stairway or ladder from the open deck. Spaces which are located below deck or spaces where access from the open deck is not provided shall be fitted with a mechanical ventilation system designed to take exhaust air from the bottom of the space and shall be sized to provide at least six air changes per hour. Access doors shall open outwards, and bulkheads and decks, including doors and other means of closing any opening therein, which form the boundaries between such rooms and adjacent enclosed spaces shall be gastight. For the purpose of the application of tables 9.1 to 9.8, such storage rooms shall be treated as fire control stations.

4.4 Water pumps for other fire-extinguishing systems

Pumps, other than those serving the fire main, required for the provision of water for fire-extinguishing systems required by this chapter, their sources of power and their controls shall be installed outside the space or spaces protected by such systems and shall be so arranged that a fire in the space or spaces protected will not put any such system out of action.

5 Fire-extinguishing arrangements in machinery spaces

5.1 Machinery spaces of category A containing oil-fired boilers or oil fuel units

5.1.1 Fixed fire-extinguishing systems

Machinery spaces of category A containing oil-fired boilers or oil fuel units shall be provided with any one of the fixed fire-extinguishing systems in paragraph 4.1. In each case, if the engine-room and boiler room are not entirely separate, or if fuel oil can drain from the boiler room into the engine-room, the combined engine and boiler rooms shall be considered as one compartment.

5.1.2 Additional fire-extinguishing arrangements*

5.1.2.1 There shall be in each boiler room or at an entrance outside of the boiler room at least one portable foam applicator unit complying with the provisions of the Fire Safety Systems Code.

5.1.2.2 There shall be at least two portable foam extinguishers or equivalent in each firing space in each boiler room and in each space in which a part of the oil fuel installation is situated. There shall be not less than one approved foam-type extinguisher of at least 135 L capacity or equivalent in each boiler room. These

* Refer to *Unified interpretation of SOLAS chapter 11-2 on the number and arrangement of portable fire extinguishers on board ships* (MSC.1/Circ.1275 and Corr.1).

extinguishers shall be provided with hoses on reels suitable for reaching any part of the boiler room. In the case of domestic boilers of less than 175 kW, or boilers protected by fixed water-based local application fire-extinguishing systems as required by paragraph 5.6, an approved foam-type extinguisher of at least 135 L capacity is not required.

5.1.2.3 In each firing space there shall be a receptacle containing at least 0.1 m³ sand, sawdust impregnated with soda, or other approved dry material, along with a suitable shovel for spreading the material. An approved portable extinguisher may be substituted as an alternative.

5.2 Machinery spaces containing internal combustion machinery

5.2.1 Fixed fire-extinguishing systems

Machinery spaces of category A containing internal combustion machinery shall be provided with one of the fixed fire-extinguishing systems in paragraph 4.1.

5.2.2 Additional fire-extinguishing arrangements*

5.2.2.1 There shall be at least one portable foam applicator unit complying with the provisions of the Fire Safety Systems Code.

5.2.2.2 There shall be in each such space approved foam-type fire extinguishers, each of at least 45 L capacity or equivalent, sufficient in number to enable foam or its equivalent to be directed onto any part of the fuel and lubricating oil pressure systems, gearing and other fire hazards. In addition, there shall be provided a sufficient number of portable foam extinguishers or equivalent which shall be so located that no point in the space is more than 10 m walking distance from an extinguisher and that there are at least two such extinguishers in each such space. For smaller spaces of cargo ships the Administration may consider relaxing this requirement.

5.3 Machinery spaces containing steam turbines or enclosed steam engines

5.3.1 Fixed fire-extinguishing systems

In spaces containing steam turbines or enclosed steam engines used for main propulsion or other purposes having in the aggregate a total output of not less than 375 kW, one of the fire-extinguishing systems specified in paragraph 4.1 shall be provided if such spaces are periodically unattended.

5.3.2 Additional fire-extinguishing arrangements

5.3.2.1 There shall be approved foam fire extinguishers, each of at least 45 L capacity or equivalent, sufficient in number to enable foam or its equivalent to be directed on to any part of the pressure lubrication system, on to any part of the casings enclosing pressure-lubricated parts of the turbines, engines or associated gearing, and any other fire hazards. However, such extinguishers shall not be required if protection, at least equivalent to that required by this subparagraph, is provided in such spaces by a fixed fire-extinguishing system fitted in compliance with paragraph 4.1.

5.3.2.2 There shall be a sufficient number of portable foam extinguishers* or equivalent which shall be so located that no point in the space is more than 10 m walking distance from an extinguisher and that there are at least two such extinguishers in each such space, except that such extinguishers shall not be required in addition to any provided in compliance with paragraph 5.1.2.2.

5.4 Other machinery spaces

Where, in the opinion of the Administration, a fire hazard exists in any machinery space for which no specific provisions for fire-extinguishing appliances are prescribed in paragraphs 5.1, 5.2 and 5.3, there shall be provided in, or adjacent to, that space such a number of approved portable fire extinguishers or other means of fire extinction as the Administration may deem sufficient.

* Refer to *Unified interpretation of SOLAS chapter II-2 on the number and arrangement of portable fire extinguishers on board ships* (MSC.1/Circ.1275 and Corr.1).

5.5 Additional requirements for passenger ships

In passenger ships carrying more than 36 passengers, each machinery space of category A shall be provided with at least two suitable water fog applicators.*

5.6 Fixed local application fire-extinguishing systems

5.6.1 Paragraph 5.6 shall apply to passenger ships of 500 gross tonnage and above and cargo ships of 2,000 gross tonnage and above.

5.6.2 Machinery spaces of category A above 500 m³ in volume shall, in addition to the fixed fire-extinguishing system required in paragraph 5.1.1, be protected by an approved type of fixed water-based or equivalent local application fire-extinguishing system, based on the guidelines developed by the Organization.† In the case of periodically unattended machinery spaces, the fire-extinguishing system shall have both automatic and manual release capabilities. In the case of continuously manned machinery spaces, the fire-extinguishing system is only required to have a manual release capability.

5.6.3 Fixed local application fire-extinguishing systems are to protect areas such as the following without the necessity of engine shutdown, personnel evacuation, or sealing of the spaces:

- .1 the fire hazard portions of internal combustion machinery or, for ships constructed before 1 July 2014, the fire hazard portions of internal combustion machinery used for the ship's main propulsion and power generation;
- .2 boiler fronts;
- .3 the fire hazard portions of incinerators; and
- .4 purifiers for heated fuel oil.

5.6.4 Activation of any local application system shall give a visual and distinct audible alarm in the protected space and at continuously manned stations. The alarm shall indicate the specific system activated. The system alarm requirements described within this paragraph are in addition to, and not a substitute for, the detection and fire alarm system required elsewhere in this chapter.

6 Fire-extinguishing arrangements in control stations, accommodation and service spaces

6.1 Sprinkler and water-spraying systems in passenger ships

6.1.1 Passenger ships carrying more than 36 passengers shall be equipped with an automatic sprinkler, fire detection and fire alarm system of an approved type complying with the requirements of the Fire Safety Systems Code in all control stations, accommodation and service spaces, including corridors and stairways. Alternatively, control stations, where water may cause damage to essential equipment, may be fitted with an approved fixed fire-extinguishing system of another type. Spaces having little or no fire risk such as voids, public toilets, carbon dioxide rooms and similar spaces need not be fitted with an automatic sprinkler system.

6.1.2 In passenger ships carrying not more than 36 passengers, when a fixed smoke detection and fire alarm system complying with the provisions of the Fire Safety Systems Code is provided only in corridors, stairways and escape routes within accommodation spaces, an automatic sprinkler system shall be installed in accordance with regulation 7.5.3.2.

6.1.3 A fixed pressure water-spraying fire-extinguishing system complying with the provisions of the Fire Safety Systems Code shall be installed on cabin balconies of ships to which regulation 5.3.4 applies, where

* A water fog applicator might consist of a metal L-shaped pipe, the long limb being about 2 m in length, capable of being fitted to a fire hose, and the short limb being about 250 mm in length, fitted with a fixed water fog nozzle or capable of being fitted with a water spray nozzle.

† Refer to *Revised guidelines for the approval of fixed water-based local application fire-fighting systems for use in category A machinery spaces* (MSC/Circ.913) (MSC.1/Circ.1387), *Unified interpretations of the Guidelines for the approval of fixed water-based local application fire-fighting systems* (MSC/Circ.913) (MSC/Circ.1082) and *Unified interpretations of SOLAS chapter 11-2* (MSC.1/Circ.1276).

furniture and furnishings on such balconies are not as defined in regulations 3.40.1, 3.40.2, 3.40.3, 3.40.6 and 3.40.7.

6.2 Sprinkler systems for cargo ships

In cargo ships in which method IIC specified in regulation 9.2.3.1.1.2 is adopted, an automatic sprinkler, fire detection and fire alarm system shall be fitted in accordance with the requirements in regulation 7.5.5.2.

6.3 Spaces containing flammable liquid

6.3.1 Paint lockers shall be protected by:

- .1 a carbon dioxide system, designed to give a minimum volume of free gas equal to 40% of the gross volume of the protected space;
- .2 a dry powder system, designed for at least 0.5 kg powder/m³;
- .3 a water-spraying or sprinkler system, designed for 5 L/m² min. Water-spraying systems may be connected to the fire main of the ship; or
- .4 a system providing equivalent protection, as determined by the Administration.

In all cases, the system shall be operable from outside the protected space.

6.3.2 Flammable liquid lockers shall be protected by an appropriate fire-extinguishing arrangement approved by the Administration.

6.3.3 For lockers of a deck area of less than 4 m², which do not give access to accommodation spaces, a portable carbon dioxide fire extinguisher sized to provide a minimum volume of free gas equal to 40% of the gross volume of the space may be accepted in lieu of a fixed system. A discharge port shall be arranged in the locker to allow the discharge of the extinguisher without having to enter into the protected space. The required portable fire extinguisher shall be stowed adjacent to the port. Alternatively, a port or hose connection may be provided to facilitate the use of fire main water.

6.4 Deep-fat cooking equipment

Deep-fat cooking equipment installed in enclosed spaces or on open decks shall be fitted with the following:

- .1 an automatic or manual fire-extinguishing system tested to an international standard acceptable to the Organization;*

SEE INTERPRETATION 23

- .2 a primary and backup thermostat with an alarm to alert the operator in the event of failure of either thermostat;
- .3 arrangements for automatically shutting off the electrical power upon activation of the fire-extinguishing system;
- .4 an alarm for indicating operation of the fire-extinguishing system in the galley where the equipment is installed; and
- .5 controls for manual operation of the fire-extinguishing system which are clearly labelled for ready use by the crew.

* Refer to the recommendations by the International Organization for Standardization, in particular publication ISO 15371:2009, *Ships and marine technology – Fire-extinguishing systems for protection of galley cooking equipment*.

7 Fire-extinguishing arrangements in cargo spaces

7.1 Fixed gas fire-extinguishing systems for general cargo

7.1.1 Except as provided for in paragraph 7.2, the cargo spaces of passenger ships of 1,000 gross tonnage and upwards shall be protected by a fixed carbon dioxide or inert gas fire-extinguishing system complying with the provisions of the Fire Safety Systems Code or by a fixed high-expansion foam fire-extinguishing system which gives equivalent protection.

7.1.2 Where it is shown to the satisfaction of the Administration that a passenger ship is engaged on voyages of such short duration that it would be unreasonable to apply the requirements of paragraph 7.1.1 and also in ships of less than 1,000 gross tonnage, the arrangements in cargo spaces shall be to the satisfaction of the Administration, provided that the ship is fitted with steel hatch covers and effective means of closing all ventilators and other openings leading to the cargo spaces.

7.1.3 Except for ro-ro and vehicle spaces, cargo spaces on cargo ships of 2,000 gross tonnage and upwards shall be protected by a fixed carbon dioxide or inert gas fire-extinguishing system complying with the provisions of the Fire Safety Systems Code, or by a fire-extinguishing system which gives equivalent protection.

SEE INTERPRETATION 24

7.1.4 The Administration may exempt from the requirements of paragraphs 7.1.3 and 7.2 cargo spaces of any cargo ship if constructed, and solely intended, for the carriage of ore, coal, grain, unseasoned timber, non-combustible cargoes or cargoes which, in the opinion of the Administration, constitute a low fire risk.* Such exemptions may be granted only if the ship is fitted with steel hatch covers and effective means of closing all ventilators and other openings leading to the cargo spaces. When such exemptions are granted, the Administration shall issue an Exemption Certificate, irrespective of the date of construction of the ship concerned, in accordance with regulation I/12(a)(vii), and shall ensure that the list of cargoes the ship is permitted to carry is attached to the Exemption Certificate.

7.2 Fixed gas fire-extinguishing systems for dangerous goods

SEE INTERPRETATION 24

A ship engaged in the carriage of dangerous goods in any cargo spaces shall be provided with a fixed carbon dioxide or inert gas fire-extinguishing system complying with the provisions of the Fire Safety Systems Code or with a fire-extinguishing system which, in the opinion of the Administration, gives equivalent protection for the cargoes carried.

7.3 Firefighting for ships constructed on or after 1 January 2016 designed to carry containers on or above the weather deck

7.3.1 Ships shall carry, in addition to the equipment and arrangements required by paragraphs 1 and 2, at least one water mist lance.

7.3.1.1 The water mist lance shall consist of a tube with a piercing nozzle which is capable of penetrating a container wall and producing water mist inside a confined space (container, etc.) when connected to the fire main.

* Refer to the IMSBC Code (resolution MSC.268(85), as amended), appendix 1, entry for coal, and to the *Lists of solid bulk cargoes for which a fixed gas fire-extinguishing system may be exempted or for which a fixed gas fire-extinguishing system is ineffective* (MSC.1/Circ.1395/Rev.4).

7.3.2 Ships designed to carry five or more tiers of containers on or above the weather deck shall carry, in addition to the requirements of paragraph 7.3.1, mobile water monitors* as follows:

- (1) ships with breadth less than 30 m: at least two mobile water monitors; or
- (2) ships with breadth of 30 m or more: at least four mobile water monitors.

7.3.2.1 The mobile water monitors, all necessary hoses, fittings and required fixing hardware shall be kept ready for use in a location outside the cargo space area not likely to be cut off in the event of a fire in the cargo spaces.

7.3.2.2 A sufficient number of fire hydrants shall be provided such that:

- .1 all provided mobile water monitors can be operated simultaneously for creating effective water barriers forward and aft of each container bay;
- .2 the two jets of water required by paragraph 2.1.5.1 can be supplied at the pressure required by paragraph 2.1.6; and
- .3 each of the required mobile water monitors can be supplied by separate hydrants at the pressure necessary to reach the top tier of containers on deck.

7.3.2.3 The mobile water monitors may be supplied by the fire main, provided the capacity of fire pumps and fire main diameter are adequate to simultaneously operate the mobile water monitors and two jets of water from fire hoses at the required pressure values. If carrying dangerous goods, the capacity of fire pumps and fire main diameter shall also comply with regulation 19.3.1.5, as far as applicable to on-deck cargo areas.

SEE INTERPRETATION 20

7.3.2.4 The operational performance of each mobile water monitor shall be tested during initial survey on board the ship to the satisfaction of the Administration. The test shall verify that:

- .1 the mobile water monitor can be securely fixed to the ship structure ensuring safe and effective operation; and
- .2 the mobile water monitor jet reaches the top tier of containers with all required monitors and water jets from fire hoses operated simultaneously.

8 Cargo tank protection

8.1 Fixed deck foam fire-extinguishing systems

8.1.1 For tankers of 20,000 tonnes deadweight and upwards, a fixed deck foam fire-extinguishing system shall be provided complying with the provisions of the Fire Safety Systems Code, except that, in lieu of the above, the Administration, after having given consideration to the ship's arrangement and equipment, may accept other fixed installations if they afford protection equivalent to the above, in accordance with regulation I/5. The requirements for alternative fixed installations shall comply with the requirements in paragraph 8.1.2.

8.1.2 In accordance with paragraph 8.1.1, where the Administration accepts an equivalent fixed installation in lieu of the fixed deck foam fire-extinguishing system, the installation shall:

- .1 be capable of extinguishing spill fires and also preclude ignition of spilled oil not yet ignited; and
- .2 be capable of combating fires in ruptured tanks.

8.1.3 Tankers of less than 20,000 tonnes deadweight shall be provided with a deck foam fire-extinguishing system complying with the requirements of the Fire Safety Systems Code.

* Refer to *Guidelines for the design, performance, testing and approval of mobile water monitors used for the protection of on-deck cargo areas of ships designed and constructed to carry five or more tiers of containers on or above the weather deck* (MSC.1/Circ.1472).

9 Protection of cargo pump-rooms in tankers

9.1 Fixed fire-extinguishing systems

Each cargo pump-room shall be provided with one of the following fixed fire-extinguishing systems operated from a readily accessible position outside the pump-room. Cargo pump-rooms shall be provided with a system suitable for machinery spaces of category A.

9.1.1 A carbon dioxide fire-extinguishing system complying with the provisions of the Fire Safety Systems Code and with the following:

- .1 the alarms giving audible warning of the release of fire-extinguishing medium shall be safe for use in a flammable cargo vapour/air mixture; and
- .2 a notice shall be exhibited at the controls stating that, due to the electrostatic ignition hazard, the system is to be used only for fire extinguishing and not for inerting purposes.

9.1.2 A high-expansion foam fire-extinguishing system complying with the provisions of the Fire Safety Systems Code, provided that the foam concentrate supply is suitable for extinguishing fires involving the cargoes carried.

9.1.3 A fixed pressure water-spraying fire-extinguishing system complying with the provisions of the Fire Safety Systems Code.

9.2 Quantity of fire-extinguishing medium

Where the fire-extinguishing medium used in the cargo pump-room system is also used in systems serving other spaces, the quantity of medium provided or its delivery rate need not be more than the maximum required for the largest compartment.

10 Fire-fighter's outfits

10.1 Types of fire-fighter's outfits

10.1.1 Fire-fighter's outfits shall comply with the Fire Safety Systems Code.

10.1.2 Self-contained compressed air breathing apparatus of fire-fighter's outfits shall comply with paragraph 2.1.2.2 of chapter 3 of the Fire Safety Systems Code by 1 July 2019.

10.2 Number of fire-fighter's outfits

10.2.1 Ships shall carry at least two fire-fighter's outfits.

10.2.2 In addition, in passenger ships there shall be provided:

- .1 for every 80 m, or part thereof, of the aggregate of the lengths of all passenger spaces and service spaces on the deck which carries such spaces or, if there is more than one such deck, on the deck which has the largest aggregate of such lengths, two fire-fighter's outfits and, in addition, two sets of personal equipment, each set comprising the items stipulated in the Fire Safety Systems Code. In passenger ships carrying more than 36 passengers, two additional fire-fighter's outfits shall be provided for each main vertical zone. However, for stairway enclosures which constitute individual main vertical zones and for the main vertical zones in the fore or aft end of a ship which do not contain spaces of categories (6), (7), (8) or (12) defined in regulation 9.2.2.3, no additional fire-fighter's outfits are required; and
- .2 on ships carrying more than 36 passengers, for each pair of breathing apparatus, one water fog applicator which shall be stored adjacent to such apparatus.

10.2.3 In addition, in tankers, two fire-fighter's outfits shall be provided.

10.2.4 The Administration may require additional sets of personal equipment and breathing apparatus, having due regard to the size and type of the ship.

10.2.5 Two spare charges shall be provided for each required breathing apparatus. Passenger ships carrying not more than 36 passengers and cargo ships that are equipped with suitably located means for fully recharging the air cylinders free from contamination need carry only one spare charge for each required apparatus. In passenger ships carrying more than 36 passengers, at least two spare charges for each breathing apparatus shall be provided.

10.2.6 Passenger ships carrying more than 36 passengers constructed on or after 1 July 2010 shall be fitted with a suitably located means for fully recharging breathing air cylinders, free from contamination. The means for recharging shall be either:

- .1 breathing air compressors supplied from the main and emergency switchboard, or independently driven, with a minimum capacity of 60 L/min per required breathing apparatus, not to exceed 420 L/min; or
- .2 self-contained high-pressure storage systems of suitable pressure to recharge the breathing apparatus used on board, with a capacity of at least 1,200 L per required breathing apparatus, not to exceed 50,000 L of free air.

10.3 Storage of fire-fighter's outfits

10.3.1 The fire-fighter's outfits or sets of personal equipment shall be kept ready for use in an easily accessible location that is permanently and clearly marked and, where more than one fire-fighter's outfit or more than one set of personal equipment is carried, they shall be stored in widely separated positions.

10.3.2 In passenger ships, at least two fire-fighter's outfits and, in addition, one set of personal equipment shall be available at any one position. At least two fire-fighter's outfits shall be stored in each main vertical zone.

10.4 Fire-fighter's communication

For ships constructed on or after 1 July 2014, a minimum of two two-way portable radiotelephone apparatus for each fire party for fire-fighter's communication shall be carried on board. Those two-way portable radiotelephone apparatus shall be of an explosion-proof type or intrinsically safe. Ships constructed before 1 July 2014 shall comply with the requirements of this paragraph not later than the first survey after 1 July 2018.

SEE INTERPRETATION 25

Regulation 11

Structural integrity

1 Purpose

The purpose of this regulation is to maintain structural integrity of the ship, preventing partial or whole collapse of the ship structures due to strength deterioration by heat. For this purpose, materials used in the ships' structure shall ensure that the structural integrity is not degraded due to fire.

2 Material of hull, superstructures, structural bulkheads, decks and deckhouses

The hull, superstructures, structural bulkheads, decks and deckhouses shall be constructed of steel or other equivalent material. For the purpose of applying the definition of steel or other equivalent material as given in regulation 3.43, the "applicable fire exposure" shall be according to the integrity and insulation standards given in tables 9.1 to 9.4. For example, where divisions such as decks or sides and ends of deckhouses are permitted to have "B-0" fire integrity, the "applicable fire exposure" shall be half an hour.

3 Structure of aluminium alloy

Unless otherwise specified in paragraph 2, in cases where any part of the structure is of aluminium alloy, the following shall apply:

- .1 the insulation of aluminium alloy components of "A" or "B" class divisions, except structure which, in the opinion of the Administration, is non-load-bearing, shall be such that the temperature of the structural core does not rise more than 200°C above the ambient temperature at any time during the applicable fire exposure to the standard fire test; and
- .2 special attention shall be given to the insulation of aluminium alloy components of columns, stanchions and other structural members required to support lifeboat and liferaft stowage, launching and embarkation areas, and "A" and "B" class divisions to ensure:
 - .1 that for such members supporting lifeboat and liferaft areas and "A" class divisions, the temperature rise limitation specified in paragraph 3.1 shall apply at the end of one hour; and
 - .2 that for such members required to support "B" class divisions, the temperature rise limitation specified in paragraph 3.1 shall apply at the end of half an hour.

4 Machinery spaces of category A

4.1 Crowns and casings

Crowns and casings of machinery spaces of category A shall be of steel construction and shall be insulated as required by tables 9.5 and 9.7, as appropriate.

4.2 Floor plating

The floor plating of normal passageways in machinery spaces of category A shall be made of steel.

5 Materials of overboard fittings

Materials readily rendered ineffective by heat shall not be used for overboard scuppers, sanitary discharges, and other outlets which are close to the waterline and where the failure of the material in the event of fire would give rise to danger of flooding.

6 Protection of cargo tank structure against pressure or vacuum in tankers

6.1 General

The venting arrangements shall be so designed and operated as to ensure that neither pressure nor vacuum in cargo tanks shall exceed design parameters and be such as to provide for:

- .1 the flow of the small volumes of vapour, air or inert gas mixtures caused by thermal variations in a cargo tank in all cases through pressure/vacuum valves; and
- .2 the passage of large volumes of vapour, air or inert gas mixtures during cargo loading and ballasting, or during discharging.

6.2 Openings for small flow by thermal variations

Openings for pressure release required by paragraph 6.1.1 shall:

- .1 have as great a height as is practicable above the cargo tank deck to obtain maximum dispersal of flammable vapours, but in no case less than 2 m above the cargo tank deck; and
- .2 be arranged at the furthest distance practicable, but not less than 5 m, from the nearest air intakes and openings to enclosed spaces containing a source of ignition and from deck machinery and equipment which may constitute an ignition hazard. Anchor windlass and chain locker openings constitute an ignition hazard.

For tankers constructed on or after 1 January 2017, the openings shall be arranged in accordance with regulation 4.5.3.4.1.

SEE INTERPRETATION 6

II-2

6.3 Safety measures in cargo tanks

6.3.1 Preventive measures against liquid rising in the venting system

Provisions shall be made to guard against liquid rising in the venting system to a height which would exceed the design head of cargo tanks. This shall be accomplished by high-level alarms or overflow control systems or other equivalent means, together with independent gauging devices and cargo tank filling procedures. For the purposes of this regulation, spill valves are not considered equivalent to an overflow system.

6.3.2 Secondary means for pressure/vacuum relief

A secondary means of allowing full flow relief of vapour, air or inert gas mixtures shall be provided to prevent over-pressure or under-pressure in the event of failure of the arrangements in paragraph 6.1.2. Alternatively, pressure sensors may be fitted in each tank protected by the arrangement required in paragraph 6.1.2, with a monitoring system in the ship's cargo control room or the position from which cargo operations are normally carried out. Such monitoring equipment shall also provide an alarm facility which is activated by detection of over-pressure or under-pressure conditions within a tank.

6.3.3 Bypasses in vent mains

Pressure/vacuum valves required by paragraph 6.1.1 may be provided with a bypass arrangement when they are located in a vent main or masthead riser. Where such an arrangement is provided there shall be suitable indicators to show whether the bypass is open or closed.

6.3.4 Pressure/vacuum-breaking devices

One or more pressure/vacuum-breaking devices shall be provided to prevent the cargo tanks from being subject to:

- .1 a positive pressure, in excess of the test pressure of the cargo tank, if the cargo were to be loaded at the maximum rated capacity and all other outlets are left shut; and
- .2 a negative pressure in excess of 700 mm water gauge if the cargo were to be discharged at the maximum rated capacity of the cargo pumps and the inert gas blowers were to fail.

Such devices shall be installed on the inert gas main unless they are installed in the venting system required by regulation 4.5.3.1 or on individual cargo tanks. The location and design of the devices shall be in accordance with regulation 4.5.3 and paragraph 6.

6.4 Size of vent outlets

Vent outlets for cargo loading, discharging and ballasting required by paragraph 6.1.2 shall be designed on the basis of the maximum designed loading rate multiplied by a factor of at least 1.25 to take account of gas evolution, in order to prevent the pressure in any cargo tank from exceeding the design pressure. The master shall be provided with information regarding the maximum permissible loading rate for each cargo tank and, in the case of combined venting systems, for each group of cargo tanks.

Part D

Escape

Regulation 12

Notification of crew and passengers

1 Purpose

The purpose of this regulation is to notify crew and passengers of a fire for safe evacuation. For this purpose, a general emergency alarm system and a public address system shall be provided.

2 General emergency alarm system

A general emergency alarm system required by regulation III/6.4.2 shall be used for notifying crew and passengers of a fire.

3 Public address systems in passenger ships

A public address system or other effective means of communication complying with the requirements of regulation III/6.5 shall be available throughout the accommodation and service spaces and control stations and open decks.

Regulation 13

Means of escape

1 Purpose

SEE INTERPRETATION 26

The purpose of this regulation is to provide means of escape so that persons on board can safely and swiftly escape to the lifeboat and liferaft embarkation deck. For this purpose, the following functional requirements shall be met:

- .1 safe escape routes shall be provided;
- .2 escape routes shall be maintained in a safe condition, clear of obstacles; and
- .3 additional aids for escape shall be provided as necessary to ensure accessibility, clear marking, and adequate design for emergency situations.

2 General requirements

2.1 Unless expressly provided otherwise in this regulation, at least two widely separated and ready means of escape shall be provided from all spaces or groups of spaces.

2.2 Lifts shall not be considered as forming one of the means of escape as required by this regulation.

3 Means of escape from control stations, accommodation spaces and service spaces

3.1 General requirements

3.1.1 Stairways and ladders shall be so arranged as to provide ready means of escape to the lifeboat and liferaft embarkation deck from passenger and crew accommodation spaces and from spaces in which the crew is normally employed, other than machinery spaces.

3.1.2 Unless expressly provided otherwise in this regulation, a corridor, lobby, or part of a corridor from which there is only one route of escape shall be prohibited. Dead-end corridors used in service areas which are necessary for the practical utility of the ship, such as fuel oil stations and athwartship supply corridors, shall be permitted, provided such dead-end corridors are separated from crew accommodation areas and are inaccessible from passenger accommodation areas. Also, a part of a corridor that has a depth not exceeding its width is considered a recess or local extension and is permitted.

3.1.3 All stairways in accommodation and service spaces and control stations shall be of steel frame construction except where the Administration sanctions the use of other equivalent material.

3.1.4 If a radiotelegraph station has no direct access to the open deck, two means of escape from, or access to, the station shall be provided, one of which may be a porthole or window of sufficient size or other means to the satisfaction of the Administration.

3.1.5 Doors in escape routes shall, in general, open in way of the direction of escape, except that:

- .1 individual cabin doors may open into the cabins in order to avoid injury to persons in the corridor when the door is opened; and
- .2 doors in vertical emergency escape trunks may open out of the trunk in order to permit the trunk to be used both for escape and for access.

3.2 Means of escape in passenger ships

3.2.1 *Escape from spaces below the bulkhead deck*

3.2.1.1 Below the bulkhead deck, two means of escape, at least one of which shall be independent of watertight doors, shall be provided from each watertight compartment or similarly restricted space or group of spaces. Exceptionally, the Administration may dispense with one of the means of escape for crew spaces that are entered only occasionally, if the required escape route is independent of watertight doors.

3.2.1.2 Where the Administration has granted dispensation under the provisions of paragraph 3.2.1.1, this sole means of escape shall provide safe escape. However, stairways shall not be less than 800 mm in clear width with handrails on both sides.

3.2.2 *Escape from spaces above the bulkhead deck*

Above the bulkhead deck there shall be at least two means of escape from each main vertical zone or similarly restricted space or group of spaces, at least one of which shall give access to a stairway forming a vertical escape.

3.2.3 *Direct access to stairway enclosures*

Stairway enclosures in accommodation and service spaces shall have direct access from the corridors and be of a sufficient area to prevent congestion, having in view the number of persons likely to use them in an emergency. Within the perimeter of such stairway enclosures, only public toilets, lockers of non-combustible material providing storage for non-hazardous safety equipment and open information counters are permitted. Only corridors, lifts, public toilets, special category spaces and open ro-ro spaces to which any passengers carried can have access, other escape stairways required by paragraph 3.2.4.1 and external areas are permitted to have direct access to these stairway enclosures. Public spaces may also have direct access to stairway enclosures except for the backstage of a theatre. Small corridors or "lobbies" used to separate an enclosed

stairway from galleys or main laundries may have direct access to the stairway provided they have a minimum deck area of 4.5 m², a width of no less than 900 mm and contain a fire hose station.

3.2.4 Details of means of escape

3.2.4.1 At least one of the means of escape required by paragraphs 3.2.1.1 and 3.2.2 shall consist of a readily accessible enclosed stairway, which shall provide continuous fire shelter from the level of its origin to the appropriate lifeboat and liferaft embarkation decks, or to the uppermost weather deck if the embarkation deck does not extend to the main vertical zone being considered. In the latter case, direct access to the embarkation deck by way of external open stairways and passageways shall be provided and shall have emergency lighting in accordance with regulation III/11.5 and slip-free surfaces underfoot. Boundaries facing external open stairways and passageways forming part of an escape route and boundaries in such a position that their failure during a fire would impede escape to the embarkation deck shall have fire integrity, including insulation values, in accordance with tables 9.1 to 9.4, as appropriate.

3.2.4.2 Protection of access from the stairway enclosures to the lifeboat and liferaft embarkation areas shall be provided either directly or through protected internal routes which have fire integrity and insulation values for stairway enclosures as determined by tables 9.1 to 9.4, as appropriate.

3.2.4.3 Stairways serving only a space and a balcony in that space shall not be considered as forming one of the required means of escape.

3.2.4.4 Each level within an atrium shall have two means of escape, one of which shall give direct access to an enclosed vertical means of escape meeting the requirements of paragraph 3.2.4.1.

3.2.4.5 The widths, number and continuity of escapes shall be in accordance with the requirements in the Fire Safety Systems Code.

3.2.5 Marking of escape routes

3.2.5.1 In addition to the emergency lighting required by regulations II-1/42 and III/11.5, the means of escape, including stairways and exits, shall be marked by lighting or photoluminescent strip indicators placed not more than 300 mm above the deck at all points of the escape route, including angles and intersections. The marking must enable passengers to identify the routes of escape and readily identify the escape exits. If electric illumination is used, it shall be supplied by the emergency source of power and it shall be so arranged that the failure of any single light or cut in a lighting strip will not result in the marking being ineffective. Additionally, escape route signs and fire equipment location markings shall be of photoluminescent material or marked by lighting. The Administration shall ensure that such lighting or photoluminescent equipment has been evaluated, tested and applied in accordance with the Fire Safety Systems Code.

3.2.5.2 In passenger ships carrying more than 36 passengers, the requirements of the paragraph 3.2.5.1 shall also apply to the crew accommodation areas.

3.2.5.3 In lieu of the escape route lighting system required by paragraph 3.2.5.1, alternative evacuation guidance systems may be accepted if approved by the Administration based on the guidelines developed by the Organization.*

3.2.6 Normally locked doors that form part of an escape route

3.2.6.1 Cabin and stateroom doors shall not require keys to unlock them from inside the room. Neither shall there be any doors along any designated escape route which require keys to unlock them when moving in the direction of escape.

* Refer to *Functional requirements and performance standards for the assessment of evacuation guidance systems* (MSC/Circ.1167) and *Interim guidelines for the testing, approval and maintenance of evacuation guidance systems used as an alternative to low-location lighting systems* (MSC/Circ.1168).

3.2.6.2 Escape doors from public spaces that are normally latched shall be fitted with a means of quick release. Such means shall consist of a door-latching mechanism incorporating a device that releases the latch upon the application of a force in the direction of escape flow. Quick release mechanisms shall be designed and installed to the satisfaction of the Administration and, in particular:

- .1 consist of bars or panels, the actuating portion of which extends across at least one half of the width of the door leaf, at least 760 mm and not more than 1,120 mm above the deck;
- .2 cause the latch to release when a force not exceeding 67 N is applied; and
- .3 not be equipped with any locking device, set screw or other arrangement that prevents the release of the latch when pressure is applied to the releasing device.

3.2.7 Evacuation analysis for passenger ships*

3.2.7.1 Escape routes shall be evaluated by an evacuation analysis early in the design process. This analysis shall apply to:

- .1 ro-ro passenger ships constructed on or after 1 July 1999; and
- .2 other passenger ships constructed on or after 1 January 2020 carrying more than 36 passengers.

3.2.7.2 The analysis shall be used to identify and eliminate, as far as practicable, congestion which may develop during an abandonment, due to normal movement of passengers and crew along escape routes, including the possibility that crew may need to move along these routes in a direction opposite to the movement of passengers. In addition, the analysis shall be used to demonstrate that escape arrangements are sufficiently flexible to provide for the possibility that certain escape routes, assembly stations, embarkation stations or survival craft may not be available as a result of a casualty.

3.3 Means of escape in cargo ships

3.3.1 General

At all levels of accommodation there shall be provided at least two widely separated means of escape from each restricted space or group of spaces.

3.3.2 Escape from spaces below the lowest open deck

Below the lowest open deck the main means of escape shall be a stairway and the second escape may be a trunk or a stairway.

SEE INTERPRETATION 27

3.3.3 Escape from spaces above the lowest open deck

Above the lowest open deck the means of escape shall be stairways or doors to an open deck or a combination thereof.

SEE INTERPRETATION 27

3.3.4 Dead-end corridors

No dead-end corridors having a length of more than 7 m shall be accepted.

3.3.5 Width and continuity of escape routes

The width, number and continuity of escape routes shall be in accordance with the requirements in the Fire Safety Systems Code.

* Refer to the Revised guidelines on evacuation analysis for new and existing passenger ships (MSC.1/Circ.1533), as may be amended.

3.3.6 Dispensation from two means of escape

Exceptionally, the Administration may dispense with one of the means of escape, for crew spaces that are entered only occasionally, if the required escape route is independent of watertight doors.

3.4 Emergency escape breathing devices

3.4.1 Emergency escape breathing devices shall comply with the Fire Safety Systems Code. Spare emergency escape breathing devices shall be kept on board.

3.4.2 All ships shall carry at least two emergency escape breathing devices within accommodation spaces.

3.4.3 In all passenger ships, at least two emergency escape breathing devices shall be carried in each main vertical zone.

3.4.4 In all passenger ships carrying more than 36 passengers, two emergency escape breathing devices, in addition to those required in paragraph 3.4.3 above, shall be carried in each main vertical zone.

3.4.5 However, paragraphs 3.4.3 and 3.4.4 do not apply to stairway enclosures which constitute individual main vertical zones and to the main vertical zones in the fore or aft end of a ship which do not contain spaces of categories (6), (7), (8) or (12) as defined in regulation 9.2.2.3.

4 Means of escape from machinery spaces

4.1 Means of escape on passenger ships

SEE INTERPRETATION 28

Means of escape from each machinery space in passenger ships shall comply with the following provisions.

4.1.1 Escape from spaces below the bulkhead deck

Where the space is below the bulkhead deck, the two means of escape shall consist of either:

- .1 two sets of steel ladders, as widely separated as possible, leading to doors in the upper part of the space, similarly separated and from which access is provided to the appropriate lifeboat and liferaft embarkation decks. One of these ladders shall be located within a protected enclosure that satisfies regulation 9.2.2.3, category (2), or regulation 9.2.2.4, category (4), as appropriate, from the lower part of the space it serves to a safe position outside the space. Self-closing fire doors of the same fire integrity standards shall be fitted in the enclosure. The ladder shall be fixed in such a way that heat is not transferred into the enclosure through non-insulated fixing points. The protected enclosure shall have minimum internal dimensions of at least 800 mm × 800 mm, and shall have emergency lighting provisions; or
- .2 one steel ladder leading to a door in the upper part of the space from which access is provided to the embarkation deck and additionally, in the lower part of the space and in a position well separated from the ladder referred to, a steel door capable of being operated from each side and which provides access to a safe escape route from the lower part of the space to the embarkation deck.

4.1.2 Escape from spaces above the bulkhead deck

Where the space is above the bulkhead deck, the two means of escape shall be as widely separated as possible and the doors leading from such means of escape shall be in a position from which access is provided to the appropriate lifeboat and liferaft embarkation decks. Where such means of escape require the use of ladders, these shall be of steel.

4.1.3 Dispensation from two means of escape

In a ship of less than 1,000 gross tonnage, the Administration may dispense with one of the means of escape, due regard being paid to the width and disposition of the upper part of the space. In a ship of 1,000 gross tonnage and above, the Administration may dispense with one means of escape from any such space, including a normally unattended auxiliary machinery space, so long as either a door or a steel ladder provides a safe

escape route to the embarkation deck, due regard being paid to the nature and location of the space and whether persons are normally employed in that space. In the steering gear space, a second means of escape shall be provided when the emergency steering position is located in that space unless there is direct access to the open deck.

II-2

4.1.4 Escape from machinery control rooms

Two means of escape shall be provided from a machinery control room located within a machinery space, at least one of which will provide continuous fire shelter to a safe position outside the machinery space.

SEE INTERPRETATION 29

4.1.5 Inclined ladders and stairways

For ships constructed on or after 1 January 2016, all inclined ladders/stairways fitted to comply with paragraph 4.1.1 with open treads in machinery spaces being part of or providing access to escape routes but not located within a protected enclosure shall be made of steel. Such ladders/stairways shall be fitted with steel shields attached to their undersides, such as to provide escaping personnel protection against heat and flame from beneath.

4.1.6 Escape from main workshops within machinery spaces

For ships constructed on or after 1 January 2016, two means of escape shall be provided from the main workshop within a machinery space. At least one of these escape routes shall provide a continuous fire shelter to a safe position outside the machinery space.

SEE INTERPRETATION 29

4.2 Means of escape on cargo ships

Means of escape from each machinery space in cargo ships shall comply with the following provisions.

SEE INTERPRETATION 30

4.2.1 Escape from machinery spaces of category A

Except as provided in paragraph 4.2.2, two means of escape shall be provided from each machinery space of category A. In particular, one of the following provisions shall be complied with:

- .1 two sets of steel ladders, as widely separated as possible, leading to doors in the upper part of the space, similarly separated and from which access is provided to the open deck. One of these ladders shall be located within a protected enclosure that satisfies regulation 9.2.3.3, category (4), from the lower part of the space it serves to a safe position outside the space. Self-closing fire doors of the same fire integrity standards shall be fitted in the enclosure. The ladder shall be fixed in such a way that heat is not transferred into the enclosure through non-insulated fixing points. The enclosure shall have minimum internal dimensions of at least 800 mm × 800 mm, and shall have emergency lighting provisions; or
- .2 one steel ladder leading to a door in the upper part of the space from which access is provided to the open deck and, additionally, in the lower part of the space and in a position well separated from the ladder referred to, a steel door capable of being operated from each side and which provides access to a safe escape route from the lower part of the space to the open deck.

4.2.2 Dispensation from two means of escape

In a ship of less than 1,000 gross tonnage, the Administration may dispense with one of the means of escape required under paragraph 4.2.1, due regard being paid to the dimension and disposition of the upper part of the space. In addition, the means of escape from machinery spaces of category A need not comply with the requirement for an enclosed fire shelter listed in paragraph 4.2.1.1. In the steering gear space, a second means

of escape shall be provided when the emergency steering position is located in that space unless there is direct access to the open deck.

4.2.3 Escape from machinery spaces other than those of category A

From machinery spaces other than those of category A, two escape routes shall be provided except that a single escape route may be accepted for spaces that are entered only occasionally and for spaces where the maximum travel distance to the door is 5 m or less.

4.2.4 Inclined ladders and stairways

For ships constructed on or after 1 January 2016, all inclined ladders/stairways fitted to comply with paragraph 4.2.1 with open treads in machinery spaces being part of or providing access to escape routes but not located within a protected enclosure shall be made of steel. Such ladders/stairways shall be fitted with steel shields attached to their undersides, such as to provide escaping personnel protection against heat and flame from beneath.

4.2.5 Escape from machinery control rooms in machinery spaces of category A

For ships constructed on or after 1 January 2016, two means of escape shall be provided from the machinery control room located within a machinery space. At least one of these escape routes shall provide a continuous fire shelter to a safe position outside the machinery space.

SEE INTERPRETATION 29

4.2.6 Escape from main workshops in machinery spaces of category A

For ships constructed on or after 1 January 2016, two means of escape shall be provided from the main workshop within a machinery space. At least one of these escape routes shall provide a continuous fire shelter to a safe position outside the machinery space.

SEE INTERPRETATION 29

4.3 Emergency escape breathing devices

4.3.1 On all ships, within the machinery spaces, emergency escape breathing devices shall be situated ready for use at easily visible places, which can be reached quickly and easily at any time in the event of fire. The location of emergency escape breathing devices shall take into account the layout of the machinery space and the number of persons normally working in the spaces.*

4.3.2 The number and location of these devices shall be indicated in the fire control plan required in regulation 15.2.4.

4.3.3 Emergency escape breathing devices shall comply with the Fire Safety Systems Code.

5 Means of escape on passenger ships from special category and open ro-ro spaces to which any passengers carried can have access

5.1 In special category and open ro-ro spaces to which any passengers carried can have access, the number and locations of the means of escape both below and above the bulkhead deck shall be to the satisfaction of the Administration and, in general, the safety of access to the embarkation deck shall be at least equivalent to that provided for under paragraphs 3.2.1.1, 3.2.2, 3.2.4.1 and 3.2.4.2. Such spaces shall be provided with designated walkways to the means of escape with a breadth of at least 600 mm. The parking arrangements for the vehicles shall maintain the walkways clear at all times.

* Refer to *Guidelines for the performance, location, use and care of emergency escape breathing devices (EEBDs)* (MSC/Circ.849).

II-2

5.2 One of the escape routes from the machinery spaces where the crew is normally employed shall avoid direct access to any special category space.

6 Means of escape from ro-ro spaces

SEE INTERPRETATION 31

At least two means of escape shall be provided in ro-ro spaces where the crew are normally employed. The escape routes shall provide a safe escape to the lifeboat and liferaft embarkation decks and shall be located at the fore and aft ends of the space.

7 Additional requirements for ro-ro passenger ships

7.1 General

7.1.1 Escape routes shall be provided from every normally occupied space on the ship to an assembly station. These escape routes shall be arranged so as to provide the most direct route possible to the assembly station,* and shall be marked with symbols based on the guidelines developed by the Organization.†

7.1.2 The escape route from cabins to stairway enclosures shall be as direct as possible, with a minimum number of changes in direction. It shall not be necessary to cross from one side of the ship to the other to reach an escape route. It shall not be necessary to climb more than two decks up or down in order to reach an assembly station or open deck from any passenger space.

7.1.3 External routes shall be provided from open decks, as referred to in paragraph 7.1.2, to the survival craft embarkation stations.

7.1.4 Where enclosed spaces adjoin an open deck, openings from the enclosed space to the open deck shall, where practicable, be capable of being used as an emergency exit.

7.1.5 Escape routes shall not be obstructed by furniture and other obstructions. With the exception of tables and chairs which may be cleared to provide open space, cabinets and other heavy furnishings in public spaces and along escape routes shall be secured in place to prevent shifting if the ship rolls or lists. Floor coverings shall also be secured in place. When the ship is under way, escape routes shall be kept clear of obstructions such as cleaning carts, bedding, luggage and boxes of goods.

7.2 Instruction for safe escape

7.2.1 Decks shall be sequentially numbered, starting with "1" at the tank top or lowest deck. The numbers shall be prominently displayed at stair landings and lift lobbies. Decks may also be named, but the deck number shall always be displayed with the name.

7.2.2 Simple "mimic" plans showing the "you are here" position and escape routes marked by arrows shall be prominently displayed on the inside of each cabin door and in public spaces. The plan shall show the directions of escape and shall be properly oriented in relation to its position on the ship.

7.3 Strength of handrails and corridors

7.3.1 Handrails or other handholds shall be provided in corridors along the entire escape route so that a firm handhold is available at every step of the way, where possible, to the assembly stations and embarkation stations. Such handrails shall be provided on both sides of longitudinal corridors more than 1.8 m in width and transverse corridors more than 1 m in width. Particular attention shall be paid to the need to be able to cross lobbies, atriums and other large open spaces along escape routes. Handrails and other handholds shall be of such strength as to withstand a distributed horizontal load of 750 N/m applied in the direction of the centre of

* Refer to *Indication of the assembly station in passenger ships* (MSC/Circ.777).

† Refer to *Symbols related to life-saving appliances and arrangements* (resolution A.760(18), as amended by resolution MSC.82(70)).

the corridor or space, and a distributed vertical load of 750 N/m applied in the downward direction. The two loads need not be applied simultaneously.

7.3.2 The lowest 0.5 m of bulkheads and other partitions forming vertical divisions along escape routes shall be able to sustain a load of 750 N/m to allow them to be used as walking surfaces from the side of the escape route with the ship at large angles of heel.

II-2

Part E

Operational requirements

Regulation 14

Operational readiness and maintenance

1 Purpose

The purpose of this regulation is to maintain and monitor the effectiveness of the fire safety measures the ship is provided with. For this purpose, the following functional requirements shall be met:

- .1 fire protection systems and fire-fighting systems and appliances shall be maintained ready for use; and
- .2 fire protection systems and fire-fighting systems and appliances shall be properly tested and inspected.

2 General requirements

At all times while the ship is in service, the requirements of paragraph 1.1 shall be complied with. A ship is not in service when:

- .1 it is in for repairs or lay-up (either at anchor or in port) or in dry-dock;
- .2 it is declared not in service by the owner or the owner's representative; and
- .3 in the case of passenger ships, there are no passengers on board.

2.1 Operational readiness

2.1.1 The following fire protection systems shall be kept in good order so as to ensure their required performance if a fire occurs:

- .1 structural fire protection, including fire-resisting divisions, and protection of openings and penetrations in these divisions;
- .2 fire detection and fire alarm systems; and
- .3 means of escape systems and appliances.

2.1.2 Fire-fighting systems and appliances shall be kept in good working order and readily available for immediate use. Portable extinguishers which have been discharged shall be immediately recharged or replaced with an equivalent unit.

2.2 Maintenance, testing and inspections

2.2.1 Maintenance, testing and inspections shall be carried out based on the guidelines developed by the Organization* and in a manner having due regard to ensuring the reliability of fire-fighting systems and appliances.

* Refer to *Revised guidelines for the maintenance and inspection of fire protection systems and appliances* (MSC.1/Circ.1432, as amended by MSC.1/Circ.1516).

2.2.2 The maintenance plan shall be kept on board the ship and shall be available for inspection whenever required by the Administration.

2.2.3 The maintenance plan shall include at least the following fire protection systems and fire-fighting systems and appliances, where installed:

- .1 fire mains, fire pumps and hydrants, including hoses, nozzles and international shore connections;
- .2 fixed fire detection and fire alarm systems;
- .3 fixed fire-extinguishing systems and other fire-extinguishing appliances;
- .4 automatic sprinkler, fire detection and fire alarm systems;
- .5 ventilation systems, including fire and smoke dampers, fans and their controls;
- .6 emergency shutdown of fuel supply;
- .7 fire doors, including their controls;
- .8 general emergency alarm systems;
- .9 emergency escape breathing devices;
- .10 portable fire extinguishers, including spare charges; and
- .11 fire-fighter's outfits.

2.2.4 The maintenance programme may be computer-based.

3 Additional requirements for passenger ships

In addition to the fire protection systems and appliances listed in paragraph 2.2.3, ships carrying more than 36 passengers shall develop a maintenance plan for low-location lighting and public address systems.

4 Additional requirements for tankers

In addition to the fire protection systems and appliances listed in paragraph 2.2.3, tankers shall have a maintenance plan for:

- .1 inert gas systems;
- .2 deck foam systems;
- .3 fire safety arrangements in cargo pump-rooms; and
- .4 flammable gas detectors.

Regulation 15

Instructions, on-board training and drills

1 Purpose

The purpose of this regulation is to mitigate the consequences of fire by means of proper instructions for training and drills of persons on board in correct procedures under emergency conditions. For this purpose, the crew shall have the necessary knowledge and skills to handle fire emergency cases, including passenger care.

2 General requirements

2.1 Instructions, duties and organization

2.1.1 Crew members shall receive instruction on fire safety on board the ship.

2.1.2 Crew members shall receive instructions on their assigned duties.

2.1.3 Parties responsible for fire extinguishing shall be organized. These parties shall have the capability to complete their duties at all times while the ship is in service.

2.2 On-board training and drills

2.2.1 Crew members shall be trained to be familiar with the arrangements of the ship as well as the location and operation of any fire-fighting systems and appliances that they may be called upon to use.

2.2.2 Training in the use of the emergency escape breathing devices shall be considered as part of on-board training.

2.2.3 Performance of crew members assigned fire-fighting duties shall be periodically evaluated by conducting on-board training and drills to identify areas in need of improvement, to ensure competency in fire-fighting skills is maintained, and to ensure the operational readiness of the fire-fighting organization.

2.2.4 On-board training in the use of the ship's fire-extinguishing systems and appliances shall be planned and conducted in accordance with the provisions of regulation III/19.4.1.

2.2.5 Fire drills shall be conducted and recorded in accordance with the provisions of regulations III/19.3 and III/19.5.

2.2.6 An onboard means of recharging breathing apparatus cylinders used during drills shall be provided or a suitable number of spare cylinders shall be carried on board to replace those used.

SEE INTERPRETATION 32

2.3 Training manuals

2.3.1 A training manual shall be provided in each crew mess room and recreation room or in each crew cabin.

2.3.2 The training manual shall be written in the working language of the ship.

2.3.3 The training manual, which may comprise several volumes, shall contain the instructions and information required in paragraph 2.3.4 in easily understood terms and illustrated wherever possible. Any part of such information may be provided in the form of audio-visual aids in lieu of the manual.

2.3.4 The training manual shall explain the following in detail:

- .1 general fire safety practice and precautions related to the dangers of smoking, electrical hazards, flammable liquids and similar common shipboard hazards;
- .2 general instructions on fire-fighting activities and fire-fighting procedures, including procedures for notification of a fire and use of manually operated call points;
- .3 meanings of the ship's alarms;
- .4 operation and use of fire-fighting systems and appliances;
- .5 operation and use of fire doors;
- .6 operation and use of fire and smoke dampers; and
- .7 escape systems and appliances.

2.4 Fire control plans*

2.4.1 General arrangement plans shall be permanently exhibited for the guidance of the ship's officers, showing clearly for each deck the control stations, the various fire sections enclosed by "A" class divisions, the

* Refer to *Graphical symbols for shipboard fire control plans* (resolution A.952(23)).

sections enclosed by "B" class divisions together with particulars of the fire detection and fire alarm systems, the sprinkler installation, the fire-extinguishing appliances, means of access to different compartments, decks, etc., and the ventilating system, including particulars of the fan control positions, the position of dampers and identification numbers of the ventilating fans serving each section. Alternatively, at the discretion of the Administration, the aforementioned details may be set out in a booklet, a copy of which shall be supplied to each officer, and one copy shall at all times be available on board in an accessible position. Plans and booklets shall be kept up to date; any alterations thereto shall be recorded as soon as practicable. Description in such plans and booklets shall be in the language or languages required by the Administration. If the language is neither English nor French, a translation into one of those languages shall be included.

2.4.2 A duplicate set of fire control plans or a booklet containing such plans shall be permanently stored in a prominently marked weathertight enclosure outside the deckhouse for the assistance of shore-side fire-fighting personnel.*

3 Additional requirements for passenger ships

3.1 Fire drills

In addition to the requirement of paragraph 2.2.3, fire drills shall be conducted in accordance with the provisions of regulation III/30, having due regard to notification of passengers and movement of passengers to assembly stations and embarkation decks.

3.2 Fire control plans

In ships carrying more than 36 passengers, plans and booklets required by this regulation shall provide information regarding fire protection, fire detection and fire extinction based on the guidelines developed by the Organization.†

Regulation 16

Operations

1 Purpose

The purpose of this regulation is to provide information and instructions for proper ship and cargo handling operations in relation to fire safety. For this purpose, the following functional requirements shall be met:

- .1 fire safety operational booklets shall be provided on board; and
- .2 flammable vapour releases from cargo tank venting shall be controlled.

2 Fire safety operational booklets

2.1 The required fire safety operational booklet shall contain the necessary information and instructions for the safe operation of the ship and cargo handling operations in relation to fire safety. The booklet shall include information concerning the crew's responsibilities for the general fire safety of the ship while loading and discharging cargo and while under way. Necessary fire safety precautions for handling general cargoes shall be explained. For ships carrying dangerous goods and flammable bulk cargoes, the fire safety operational booklet shall also provide reference to the pertinent fire-fighting and emergency cargo handling instructions contained in the International Maritime Solid Bulk Cargoes (IMSBC) Code, the International Bulk Chemical Code, the International Gas Carrier Code and the International Maritime Dangerous Goods Code, as appropriate.

* Refer to *Guidance concerning the location of fire control plans for the assistance of shoreside fire-fighting personnel* (MSC/Circ.451).

† Refer to *Guidelines on the information to be provided with fire control plans and booklets required by SOLAS regulations II-2/20 and 41-2* (resolution A.756(18)).

2.2 The fire safety operational booklet shall be provided in each crew mess room and recreation room or in each crew cabin.

2.3 The fire safety operational booklet shall be written in the working language of the ship.

2.4 The fire safety operational booklet may be combined with the training manuals required in regulation 15.2.3.

3 Additional requirements for tankers

3.1 General

The fire safety operational booklet referred to in paragraph 2 shall include provisions for preventing fire spread to the cargo area due to ignition of flammable vapours and include procedures of cargo tank gas-purging and/or gas-freeing, taking into account the provisions in paragraph 3.2.

3.2 Procedures for cargo tank purging and/or gas-freeing

3.2.1 When the ship is provided with an inert gas system, the cargo tanks shall first be purged in accordance with the provisions of regulation 4.5.6 until the concentration of hydrocarbon vapours in the cargo tanks has been reduced to less than 2% by volume. Thereafter, gas-freeing may take place at the cargo tank deck level.

3.2.2 When the ship is not provided with an inert gas system, the operation shall be such that the flammable vapour is discharged initially through:

- .1 the vent outlets as specified in regulation 4.5.3.4;
- .2 outlets at least 2 m above the cargo tank deck level with a vertical efflux velocity of at least 30 m/s maintained during the gas-freeing operation; or
- .3 outlets at least 2 m above the cargo tank deck level with a vertical efflux velocity of at least 20 m/s and which are protected by suitable devices to prevent the passage of flame.

3.2.3 The above outlets shall be located not less than 10 m, measured horizontally, from the nearest air intakes and openings to enclosed spaces containing a source of ignition and from deck machinery, which may include anchor windlass and chain locker openings, and equipment which may constitute an ignition hazard.

SEE INTERPRETATION 6

3.2.4 When the flammable vapour concentration at the outlet has been reduced to 30% of the lower flammable limit, gas-freeing may be continued at cargo tank deck level.

3.3 Operation of inert gas system

3.3.1 The inert gas system for tankers required in accordance with regulation 4.5.5.1 shall be so operated as to render and maintain the atmosphere of the cargo tanks non-flammable, except when such tanks are required to be gas-free.

3.3.2 Notwithstanding the above, for chemical tankers, the application of inert gas may take place after the cargo tank has been loaded, but before commencement of unloading and shall continue to be applied until that cargo tank has been purged of all flammable vapours before gas-freeing. Only nitrogen is acceptable as inert gas under this provision.

SEE INTERPRETATION 33

3.3.3 Notwithstanding regulation 1.2.2.2, the provisions of this paragraph shall only apply to tankers constructed on or after 1 January 2016. If the oxygen content of the inert gas exceeds 5% by volume, immediate action shall be taken to improve the gas quality. Unless the quality of the gas improves, all operations in those cargo tanks to which inert gas is being supplied shall be suspended so as to avoid air being drawn into the

cargo tanks, the gas regulating valve, if fitted, shall be closed and the off specification gas shall be vented to atmosphere.

SEE INTERPRETATION 33

3.3.4 In the event that the inert gas system is unable to meet the requirement in paragraph 16.3.3.1 and it has been assessed that it is impractical to effect a repair, then cargo discharge and cleaning of those cargo tanks requiring inerting shall only be resumed when suitable emergency procedures have been followed, taking into account guidelines developed by the Organization.*

11-2

* Refer to *Clarification of inert gas system requirements under SOLAS 1974 (MSC/Circ.485, as amended)* and *Revised guidelines for inert gas systems (MSC/Circ.353, as amended by MSC/Circ.387)*.

Part F

Alternative design and arrangements

Regulation 17

Alternative design and arrangements

1 Purpose

The purpose of this regulation is to provide a methodology for alternative design and arrangements for fire safety.

2 General

2.1 Fire safety design and arrangements may deviate from the prescriptive requirements set out in parts B, C, D, E or G, provided that the design and arrangements meet the fire safety objectives and the functional requirements.

2.2 When fire safety design or arrangements deviate from the prescriptive requirements of this chapter, engineering analysis, evaluation and approval of the alternative design and arrangements shall be carried out in accordance with this regulation.

3 Engineering analysis

The engineering analysis shall be prepared and submitted to the Administration, based on the guidelines developed by the Organization,* and shall include, as a minimum, the following elements:

- .1 determination of the ship type and space(s) concerned;
- .2 identification of prescriptive requirement(s) with which the ship or the space(s) will not comply;
- .3 identification of the fire and explosion hazards of the ship or the space(s) concerned, including:
 - .1 identification of the possible ignition sources;
 - .2 identification of the fire growth potential of each space concerned;
 - .3 identification of the smoke and toxic effluent generation potential for each space concerned;
 - .4 identification of the potential for the spread of fire, smoke or of toxic effluents from the space(s) concerned to other spaces;
- .4 determination of the required fire safety performance criteria for the ships or the space(s) concerned addressed by the prescriptive requirement(s), in particular:
 - .1 performance criteria shall be based on the fire safety objectives and on the functional requirements of this chapter;
 - .2 performance criteria shall provide a degree of safety not less than that achieved by using the prescriptive requirements;
 - .3 performance criteria shall be quantifiable and measurable;

* Refer to *Guidelines on alternative design and arrangements for fire safety* (MSC/Circ.1002 and its Corr.1, Corr.2 and Corr.3, as amended by MSC.1/Circ.1552).

- .5 detailed description of the alternative design and arrangements, including a list of the assumptions used in the design and any proposed operational restrictions or conditions; and
- .6 technical justification demonstrating that the alternative design and arrangements meet the required fire safety performance criteria.

4 Evaluation of the alternative design and arrangements

4.1 The engineering analysis required in paragraph 3 shall be evaluated and approved by the Administration, taking into account the guidelines developed by the Organization.*

4.2 A copy of the documentation, as approved by the Administration, indicating that the alternative design and arrangements comply with this regulation shall be carried on board the ship.

5 Exchange of information

The Administration shall communicate to the Organization pertinent information concerning alternative design and arrangements approved by them for circulation to all Contracting Governments.

6 Re-evaluation due to change of conditions

If the assumptions and operational restrictions that were stipulated in the alternative design and arrangements are changed, the engineering analysis shall be carried out under the changed condition and shall be approved by the Administration.

* Refer to *Guidelines on alternative design and arrangements for fire safety* (MSC/Circ.1002 and its Corr.1, Corr.2 and Corr.3, as amended by MSC.1/Circ.1552).

II-2

Part G

Special requirements

Regulation 18

Helicopter facilities

1 Purpose

The purpose of this regulation is to provide additional measures in order to address the fire safety objectives of this chapter for ships fitted with special facilities for helicopters. For this purpose, the following functional requirements shall be met:

- .1 helideck structure shall be adequate to protect the ship from the fire hazards associated with helicopter operations;
- .2 fire-fighting appliances shall be provided to adequately protect the ship from the fire hazards associated with helicopter operations;
- .3 refuelling and hangar facilities and operations shall provide the necessary measures to protect the ship from the fire hazards associated with helicopter operations; and
- .4 operation manuals and training shall be provided.

2 Application

2.1 In addition to complying with the requirements of regulations in parts B, C, D and E, as appropriate, ships equipped with helidecks shall comply with the requirements of this regulation.

2.2 Where helicopters land or conduct winching operations on an occasional or emergency basis on ships without helidecks, fire-fighting equipment fitted in accordance with the requirements in part C may be used. This equipment shall be made readily available in close proximity to the landing or winching areas during helicopter operations.

2.3 Notwithstanding the requirements of paragraph 2.2 above, ships constructed on or after 1 January 2020, having a helicopter landing area, shall be provided with foam firefighting appliances which comply with the relevant provisions of chapter 17 of the Fire Safety Systems Code.

2.4 Notwithstanding the requirements of paragraph 2.2 or 2.3 above, ro-ro passenger ships without helidecks shall comply with regulation III/28.

3 Structure

3.1 Construction of steel or other equivalent material

In general, the construction of the helidecks shall be of steel or other equivalent materials. If the helideck forms the deckhead of a deckhouse or superstructure, it shall be insulated to "A-60" class standard.

3.2 Construction of aluminium or other low melting point metals

If the Administration permits aluminium or other low melting point metal construction that is not made equivalent to steel, the following provisions shall be satisfied:

- .1 if the platform is cantilevered over the side of the ship, after each fire on the ship or on the platform, the platform shall undergo a structural analysis to determine its suitability for further use; and
- .2 if the platform is located above the ship's deckhouse or similar structure, the following conditions shall be satisfied:
 - .1 the deckhouse top and bulkheads under the platform shall have no openings;
 - .2 windows under the platform shall be provided with steel shutters; and
 - .3 after each fire on the platform or in close proximity, the platform shall undergo a structural analysis to determine its suitability for further use.

4 Means of escape

A helideck shall be provided with both a main and an emergency means of escape and access for fire fighting and rescue personnel. These shall be located as far apart from each other as is practicable and preferably on opposite sides of the helideck.

5 Fire-fighting appliances

5.1 In close proximity to the helideck, the following fire-fighting appliances shall be provided and stored near the means of access to that helideck:

- .1 at least two dry powder extinguishers having a total capacity of not less than 45 kg;*
 - .2 carbon dioxide extinguishers of a total capacity of not less than 18 kg or equivalent;*
 - .3 a suitable foam application system consisting of monitors or foam-making branch pipes capable of delivering foam to all parts of the helideck in all weather conditions in which helicopters can operate. The system shall be capable of delivering a discharge rate as required in table 18.1 for at least 5 min;

Table 18.1 – Foam discharge rates

Category	Helicopter overall length	Discharge rate foam solution (L/min)
H1	up to but not including 15 m	250
H2	from 15 m up to but not including 24 m	500
H3	from 24 m up to but not including 35 m	800

- .4 the principal agent shall be suitable for use with salt water and conform to performance standards not inferior to those acceptable to the Organization;†
- .5 at least two nozzles of an approved dual-purpose type (jet/spray) and hoses sufficient to reach any part of the helideck;
- .6 in lieu of the requirements of paragraphs 5.1.3 through 5.1.5, on ships constructed on or after 1 January 2020 having a helideck, foam firefighting appliances which comply with the provisions of the Fire Safety Systems Code;

* Refer to *Unified interpretation of SOLAS chapter II-2 on the number and arrangement of portable fire extinguishers on board ships* (MSC.1/Circ.1275 and its Corr.1).

† Refer to the *International Civil Aviation Organization Airport Services Manual*, part 1, Rescue and Fire Fighting, chapter 8, Extinguishing Agent Characteristics, paragraph 8.1.5, Foam Specifications table 8-1, level 'B'.

- .7 in addition to the requirements of regulation 10.10, two sets of fire-fighter's outfits; and
- .8 at least the following equipment shall be stored in a manner that provides for immediate use and protection from the elements:
 - .1 adjustable wrench;
 - .2 blanket, fire-resistant;
 - .3 cutters, bolt, 60 cm;
 - .4 hook, grab or salving;
 - .5 hacksaw, heavy duty complete with six spare blades;
 - .6 ladder;
 - .7 lift line 5 mm diameter and 15 m in length;
 - .8 pliers, side-cutting;
 - .9 set of assorted screwdrivers; and
 - .10 harness knife complete with sheath.

6 Drainage facilities

Drainage facilities in way of helidecks shall be constructed of steel and shall lead directly overboard independent of any other system and shall be designed so that drainage does not fall onto any part of the ship.

7 Helicopter refuelling and hangar facilities

Where the ship has helicopter refuelling and hangar facilities, the following requirements shall be complied with:

- .1 a designated area shall be provided for the storage of fuel tanks which shall be:
 - .1 as remote as is practicable from accommodation spaces, escape routes and embarkation stations; and
 - .2 isolated from areas containing a source of vapour ignition;
- .2 the fuel storage area shall be provided with arrangements whereby fuel spillage may be collected and drained to a safe location;
- .3 tanks and associated equipment shall be protected against physical damage and from a fire in an adjacent space or area;
- .4 where portable fuel storage tanks are used, special attention shall be given to:
 - .1 design of the tank for its intended purpose;
 - .2 mounting and securing arrangements;
 - .3 electric bonding; and
 - .4 inspection procedures;
- .5 storage tank fuel pumps shall be provided with means which permit shutdown from a safe remote location in the event of a fire. Where a gravity fuelling system is installed, equivalent closing arrangements shall be provided to isolate the fuel source;
- .6 the fuel pumping unit shall be connected to one tank at a time. The piping between the tank and the pumping unit shall be of steel or equivalent material, as short as possible, and protected against damage;
- .7 electrical fuel pumping units and associated control equipment shall be of a type suitable for the location and potential hazards;

- .8 fuel pumping units shall incorporate a device which will prevent over-pressurization of the delivery or filling hose;
- .9 equipment used in refuelling operations shall be electrically bonded;
- .10 "NO SMOKING" signs shall be displayed at appropriate locations;
- .11 hangar, refuelling and maintenance facilities shall be treated as category A machinery spaces with regard to structural fire protection, fixed fire-extinguishing and detection system requirements;
- .12 enclosed hangar facilities or enclosed spaces containing refuelling installations shall be provided with mechanical ventilation, as required by regulation 20.3 for closed ro-ro spaces of cargo ships. Ventilation fans shall be of non-sparking type; and
- .13 electric equipment and wiring in enclosed hangars or enclosed spaces containing refuelling installations shall comply with regulations 20.3.2, 20.3.3 and 20.3.4.

8 Operations manual and fire-fighting arrangements

- 8.1 Each helicopter facility shall have an operations manual, including a description and a checklist of safety precautions, procedures and equipment requirements. This manual may be part of the ship's emergency response procedures.
- 8.2 The procedures and precautions to be followed during refuelling operations shall be in accordance with recognized safe practices and contained in the operations manual.
- 8.3 Fire-fighting personnel, consisting of at least two persons trained for rescue and fire-fighting duties, and fire-fighting equipment shall be immediately available at all times when helicopter operations are expected.
- 8.4 Fire-fighting personnel shall be present during refuelling operations. However, the fire-fighting personnel shall not be involved with refuelling activities.
- 8.5 On-board refresher training shall be carried out and additional supplies of fire-fighting media shall be provided for training and testing of the equipment.

Regulation 19

*Carriage of dangerous goods**

1 Purpose

The purpose of this regulation is to provide additional safety measures in order to address the fire safety objectives of this chapter for ships carrying dangerous goods. For this purpose, the following functional requirements shall be met:

- .1 fire protection systems shall be provided to protect the ship from the added fire hazards associated with carriage of dangerous goods;
- .2 dangerous goods shall be adequately separated from ignition sources; and
- .3 appropriate personnel protective equipment shall be provided for the hazards associated with the carriage of dangerous goods.

2 General requirements

2.1 In addition to complying with the requirements of regulations in parts B, C, D, E and regulations 18 and 20,[†] as appropriate, ship types and cargo spaces, referred to in paragraph 2.2, intended for the carriage of

* Refer to *Interim guidelines for open-top containerhips* (MSC/Circ.608/Rev.1).

† Refer to part 7 of the IMDG Code.

dangerous goods shall comply with the requirements of this regulation, as appropriate, except when carrying dangerous goods in limited quantities* and excepted quantities† unless such requirements have already been met by compliance with the requirements elsewhere in this chapter. The types of ships and modes of carriage of dangerous goods are referred to in paragraph 2.2 and in table 19.1. Cargo ships of less than 500 gross tonnage shall comply with this regulation, but Administrations may reduce the requirements and such reduced requirements shall be recorded in the document of compliance referred to in paragraph 4.

2.2 The following ship types and cargo spaces shall govern the application of tables 19.1 and 19.2:

- .1 ships and cargo spaces not specifically designed for the carriage of freight containers, but intended for the carriage of dangerous goods in packaged form, including goods in freight containers and portable tanks;
- .2 purpose-built containerships and cargo spaces intended for the carriage of dangerous goods in freight containers and portable tanks;
- .3 ro-ro ships and ro-ro spaces intended for the carriage of dangerous goods;
- .4 ships and cargo spaces intended for the carriage of solid dangerous goods in bulk; and
- .5 ships and cargo spaces intended for carriage of dangerous goods other than liquids and gases in bulk in shipborne barges.

3 Special requirements

Unless otherwise specified, the following requirements shall govern the application of tables 19.1, 19.2 and 19.3 to both “on-deck” and “under-deck” stowage of dangerous goods where the numbers of the following paragraphs are indicated in the first column of the tables.

3.1 Water supplies

SEE INTERPRETATION 20

3.1.1 Arrangements shall be made to ensure immediate availability of a supply of water from the fire main at the required pressure either by permanent pressurization or by suitably placed remote arrangements for the fire pumps.

3.1.2 The quantity of water delivered shall be capable of supplying four nozzles of a size and at pressures as specified in regulation 10.2, capable of being trained on any part of the cargo space when empty. This amount of water may be applied by equivalent means to the satisfaction of the Administration.

3.1.3 Means shall be provided for effectively cooling the designated under-deck cargo space by at least 5 L/min per square metre of the horizontal area of cargo spaces, either by a fixed arrangement of spraying nozzles or by flooding the cargo space with water. Hoses may be used for this purpose in small cargo spaces and in small areas of larger cargo spaces at the discretion of the Administration. However, the drainage and pumping arrangements shall be such as to prevent the build-up of free surfaces. The drainage system shall be sized to remove no less than 125% of the combined capacity of both the water-spraying system pumps and the required number of fire hose nozzles. The drainage system valves shall be operable from outside the protected space at a position in the vicinity of the extinguishing system controls. Bilge wells shall be of sufficient holding capacity and shall be arranged at the side shell of the ship at a distance from each other of not more than 40 m in each watertight compartment. If this is not possible, the adverse effect upon stability of the added weight and free surface of water shall be taken into account to the extent deemed necessary by the Administration in its approval of the stability information.‡

3.1.4 Provision to flood a designated under-deck cargo space with suitable specified media may be substituted for the requirements in paragraph 3.1.3.

* Refer to chapter 3.4 of the IMDG Code.

† Refer to chapter 3.5 of the IMDG Code.

‡ Refer to *Recommendation on fixed fire-extinguishing systems for special category spaces* (resolution A.123(V)).

3.1.5 The total required capacity of the water supply shall satisfy paragraphs 3.1.2 and 3.1.3, if applicable, simultaneously calculated for the largest designated cargo space. The capacity requirements of paragraph 3.1.2 shall be met by the total capacity of the main fire pump(s), not including the capacity of the emergency fire pump, if fitted. If a drencher system is used to satisfy paragraph 3.1.3, the drencher pump shall also be taken into account in this total capacity calculation.

3.2 Sources of ignition

SEE INTERPRETATION 34

Electrical equipment and wiring shall not be fitted in enclosed cargo spaces or vehicle spaces unless it is essential for operational purposes in the opinion of the Administration. However, if electrical equipment is fitted in such spaces, it shall be of a certified safe type* for use in the dangerous environments to which it may be exposed unless it is possible to completely isolate the electrical system (e.g. by removal of links in the system, other than fuses). Cable penetrations of the decks and bulkheads shall be sealed against the passage of gas or vapour. Through runs of cables and cables within the cargo spaces shall be protected against damage from impact. Any other equipment which may constitute a source of ignition of flammable vapour shall not be permitted.

3.3 Detection system

Ro-ro spaces shall be fitted with a fixed fire detection and fire alarm system complying with the requirements of the Fire Safety Systems Code. All other types of cargo spaces shall be fitted with either a fixed fire detection and fire alarm system or a sample extraction smoke detection system complying with the requirements of the Fire Safety Systems Code. If a sample extraction smoke detection system is fitted, particular attention shall be given to paragraph 2.1.3 in chapter 10 of the Fire Safety Systems Code in order to prevent the leakage of toxic fumes into occupied areas.

3.4 Ventilation arrangement

SEE INTERPRETATION 35

3.4.1 Adequate power ventilation shall be provided in enclosed cargo spaces. The arrangement shall be such as to provide for at least six air changes per hour in the cargo space, based on an empty cargo space, and for removal of vapours from the upper or lower parts of the cargo space, as appropriate.

3.4.2 The fans shall be such as to avoid the possibility of ignition of flammable gas/air mixtures. Suitable wire mesh guards shall be fitted over inlet and outlet ventilation openings.

3.4.3 Natural ventilation shall be provided in enclosed cargo spaces intended for the carriage of solid dangerous goods in bulk, where there is no provision for mechanical ventilation.

3.5 Bilge pumping

3.5.1 Where it is intended to carry flammable or toxic liquids in enclosed cargo spaces, the bilge pumping system shall be designed to protect against inadvertent pumping of such liquids through machinery space piping or pumps. Where large quantities of such liquids are carried, consideration shall be given to the provision of additional means of draining those cargo spaces.

3.5.2 If the bilge drainage system is additional to the system served by pumps in the machinery space, the capacity of the system shall be not less than 10 m³/h per cargo space served. If the additional system is common, the capacity need not exceed 25 m³/h. The additional bilge system need not be arranged with redundancy.

3.5.3 Whenever flammable or toxic liquids are carried, the bilge line into the machinery space shall be isolated either by fitting a blank flange or by a closed lockable valve.

* Refer to the recommendations of the International Electrotechnical Commission, in particular publication IEC 60092, *Electrical installations in ships*.

3.5.4 Enclosed spaces outside machinery spaces containing bilge pumps serving cargo spaces intended for carriage of flammable or toxic liquids shall be fitted with separate mechanical ventilation giving at least six air changes per hour. If the space has access from another enclosed space, the door shall be self-closing.

3.5.5 If bilge drainage of cargo spaces is arranged by gravity drainage, the drainage shall be either led directly overboard or to a closed drain tank located outside the machinery spaces. The tank shall be provided with a vent pipe to a safe location on the open deck. Drainage from a cargo space into bilge wells in a lower space is only permitted if that space satisfies the same requirements as the cargo space above.

3.6 Personnel protection

3.6.1 Four sets of full protective clothing, resistant to chemical attack, shall be provided in addition to the fire-fighter's outfits required by regulation 10.10 and shall be selected taking into account the hazards associated with the chemicals being transported and the standards developed by the Organization according to the class and physical state.* The protective clothing shall cover all skin, so that no part of the body is unprotected.

3.6.2 At least two self-contained breathing apparatuses additional to those required by regulation 10.10 shall be provided. Two spare charges suitable for use with the breathing apparatus shall be provided for each required apparatus. Passenger ships carrying not more than 36 passengers and cargo ships that are equipped with suitably located means for fully recharging the air cylinders free from contamination need carry only one spare charge for each required apparatus.

3.7 Portable fire extinguishers[†]

Portable fire extinguishers with a total capacity of at least 12 kg of dry powder or equivalent shall be provided for the cargo spaces. These extinguishers shall be in addition to any portable fire extinguishers required elsewhere in this chapter.

3.8 Insulation of machinery space boundaries

Bulkheads forming boundaries between cargo spaces and machinery spaces of category A shall be insulated to "A-60" class standard, unless the dangerous goods are stowed at least 3 m horizontally away from such bulkheads. Other boundaries between such spaces shall be insulated to "A-60" class standard.

3.9 Water-spray system

Each open ro-ro space having a deck above it and each space deemed to be a closed ro-ro space not capable of being sealed shall be fitted with an approved fixed pressure water-spraying system for manual operation which shall protect all parts of any deck and vehicle platform in the space, except that the Administration may permit the use of any other fixed fire-extinguishing system that has been shown by full-scale test to be no less effective. However, the drainage and pumping arrangements shall be such as to prevent the build-up of free surfaces. The drainage system shall be sized to remove no less than 125% of the combined capacity of both the water-spraying system pumps and the required number of fire hose nozzles. The drainage system valves shall be operable from outside the protected space at a position in the vicinity of the extinguishing system controls. Bilge wells shall be of sufficient holding capacity and shall be arranged at the side shell of the ship at a distance from each other of not more than 40 m in each watertight compartment. If this is not possible, the adverse effect upon stability of the added weight and free surface of water shall be taken into account to the extent deemed necessary by the Administration in its approval of the stability information.[‡]

* For solid bulk cargoes, the protective clothing should satisfy the equipment provisions specified in the respective schedules of the IMSBC Code for the individual substances. For packaged goods, the protective clothing should satisfy the equipment provisions specified in emergency procedures (EmS) of the Supplement to the IMDG Code for the individual substances.

[†] Refer to *Unified interpretation of SOLAS chapter II-2 on the number and arrangement of portable fire extinguishers on board ships* (MSC.1/Circ.1275 and its Corr.1).

[‡] Refer to *Recommendation on fixed fire-extinguishing systems for special category spaces* (resolution A.123(V)).

3.10 Separation of ro-ro spaces

3.10.1 In ships having ro-ro spaces, a separation shall be provided between a closed ro-ro space and an adjacent open ro-ro space. The separation shall be such as to minimize the passage of dangerous vapours and liquids between such spaces. Alternatively, such separation need not be provided if the ro-ro space is considered to be a closed cargo space over its entire length and fully complies with the relevant special requirements of this regulation.

3.10.2 In ships having ro-ro spaces, a separation shall be provided between a closed ro-ro space and the adjacent weather deck. The separation shall be such as to minimize the passage of dangerous vapours and liquids between such spaces. Alternatively, a separation need not be provided if the arrangements of the closed ro-ro spaces are in accordance with those required for the dangerous goods carried on adjacent weather decks.

Table 19.1 – Application of the requirements to different modes of carriage of dangerous goods in ships and cargo spaces

Where X appears in table 19.1, it means this requirement is applicable to all classes of dangerous goods as given in the appropriate line of table 19.3, except as indicated by the notes.

Regulation 19.2.2 Regulation 19	Weather decks (.1 to .5 inclusive)	.1 Not specifically designed	.2 Container cargo spaces	.3		.4 Solid dangerous goods in bulk	.5 Shipborne barges
				Closed ro-ro spaces ⁵	Open ro-ro spaces		
.3.1.1	X	X	X	X	X	For application of requirements of regulation 19 to different classes of dangerous goods, see table 19.2	X
.3.1.2	X	X	X	X	X		–
.3.1.3	–	X	X	X	X		X
.3.1.4	–	X	X	X	X		X
.3.2	–	X	X	X	X		X ⁴
.3.3	–	X	X	X	–		X ⁴
.3.4.1	–	X	X ¹	X	–		X ⁴
.3.4.2	–	X	X ¹	X	–		X ⁴
.3.5	–	X	X	X	–		–
.3.6.1	X	X	X	X	X		–
.3.6.2	X	X	X	X	X		–
.3.7	X	X	–	–	X		–
.3.8	X	X	X ²	X	X		–
.3.9	–	–	–	X ³	X		–
.3.10.1	–	–	–	X	–	–	
.3.10.2	–	–	–	X	–	–	

Notes

¹ For classes 4 and 5.1 solids not applicable to closed freight containers. For classes 2, 3, 6.1 and 8 when carried in closed freight containers, the ventilation rate may be reduced to not less than two air changes per hour. For classes 4 and 5.1 liquids when carried in closed freight containers, the ventilation rate may be reduced to not less than two air changes per hour. For the purpose of this requirement, a portable tank is a closed freight container.

² Applicable to decks only.

³ Applies only to closed ro-ro spaces, not capable of being sealed.

⁴ In the special case where the barges are capable of containing flammable vapours or alternatively if they are capable of discharging flammable vapours to a safe space outside the barge carrier compartment by means of ventilation ducts connected to the barges, these requirements may be reduced or waived to the satisfaction of the Administration.

⁵ Special category spaces shall be treated as closed ro-ro spaces when dangerous goods are carried.

Table 19.2 – Application of the requirements to different classes of dangerous goods for ships and cargo spaces carrying solid dangerous goods in bulk

Class \ Regulation 19	4.1	4.2	4.3 ⁶	5.1	6.1	8	9
.3.1.1	X	X	–	X	–	–	X
.3.1.2	X	X	–	X	–	–	X
.3.2	X	X ⁷	X	X ⁸	–	–	X ⁸
.3.4.1	–	X ⁷	X	–	–	–	–
.3.4.2	X ⁹	X ⁷	X	X ^{7,9}	–	–	X ^{7,9}
.3.4.3	X	X	X	X	X	X	X
.3.6	X	X	X	X	X	X	X
.3.8	X	X	X	X ⁷	–	–	X ¹⁰

Notes

⁶ The hazards of substances in this class which may be carried in bulk are such that special consideration shall be given by the Administration to the construction and equipment of the ship involved in addition to meeting the requirements enumerated in this table.

⁷ Only applicable to Seedcake containing solvent extractions, to Ammonium nitrate and to Ammonium nitrate fertilizers.

⁸ Only applicable to Ammonium nitrate and to Ammonium nitrate fertilizers. However, a degree of protection in accordance with standards contained in the International Electrotechnical Commission publication IEC 60079, *Electrical apparatus for explosive gas atmospheres*, is sufficient.

⁹ Only suitable wire mesh guards are required.

¹⁰ The requirements of the IMSBC Code, as amended, are sufficient.

Table 19.3 – Application of the requirements to different classes of dangerous goods except solid dangerous goods in bulk

Class	1.1 to 1.6	1.45	2.1	2.2	2.3 flammable ²⁰	2.3 non-flammable	3 FP15 < 23°C	3 FP15 ≥ 23°C to ≤ 60°C	4.1	4.2	4.3 liquids ²¹	4.3 solids	5.1	5.2 ¹⁶	6.1 liquids FP15 < 23°C	6.1 liquids FP15 ≥ 23°C to ≤ 60°C	6.1 liquids	6.1 solids	6 liquids FP15 ≥ 23°C to ≤ 60°C	6 liquids	6 solids	9
Regulation 19																						
.3.1.1	X	X	X	X	X	X	X	X	X	X	X	X	X	X	X	X	X	X	X	X	X	X
.3.1.2	X	X	X	X	X	X	X	X	X	X	X	X	X	X	X	X	X	X	X	X	X	X
.3.1.3	X	-	-	-	-	-	-	-	-	-	-	-	-	-	-	-	-	-	-	-	-	-
.3.1.4	X	-	-	-	-	-	-	-	-	-	-	-	-	-	-	-	-	-	-	-	-	-
.3.2	X	-	X	-	X	-	X	-	-	-	X ¹⁸	-	-	-	X	-	-	-	-	-	-	X ¹⁷
.3.3	X	X	X	X	-	X	X	X	X	X	X	X	X	-	X	X	X	X	X	X	X	-
.3.4.1	-	-	X	-	-	X	-	-	X ¹¹	X ¹¹	X	X	X ¹¹	-	X	X	-	X ¹¹	X	-	-	X ¹¹
.3.4.2	-	-	X	-	-	-	-	-	-	-	-	-	-	-	X	-	-	-	-	-	-	X ¹⁷
.3.5	-	-	-	-	-	-	X	-	-	-	-	-	-	-	X	X	X	-	X ¹⁹	-	-	-
.3.6	-	-	X	X	X	X	X	X	X	X	X	X	X	X	X	X	X	X	X	X	X	X ¹⁴
.3.7	-	-	-	-	-	-	X	X	X	X	X	X	X	-	X	X	X	-	-	-	-	-
.3.8	X ¹²	-	X	X	X	X	X	X	X	X	X	X	X ¹³	X	X	X	X	-	X ¹⁹	-	-	-
.3.9	X	X	X	X	X	X	X	X	X	X	X	X	X	X	X	X	X	X	X	X	X	X
.3.10.1	X	X	X	X	X	X	X	X	X	X	X	X	X	X	X	X	X	X	X	X	X	X
.3.10.2	X	X	X	X	X	X	X	X	X	X	X	X	X	X	X	X	X	X	X	X	X	X

Notes

- ¹¹ When "mechanically-ventilated spaces" are required by the IMDG Code.
- ¹² Stow 3 m horizontally away from the machinery space boundaries in all cases.
- ¹³ Refer to the IMDG Code.
- ¹⁴ As appropriate for the goods to be carried.
- ¹⁵ FP means flashpoint.
- ¹⁶ Under the provisions of the IMDG Code, stowage of class 5.2 dangerous goods under deck or in enclosed ro-ro spaces is prohibited.
- ¹⁷ Only applicable to dangerous goods evolving flammable vapour listed in the IMDG Code.
- ¹⁸ Only applicable to dangerous goods having a flashpoint less than 23°C listed in the IMDG Code.
- ¹⁹ Only applicable to dangerous goods having a subsidiary risk class 6.1.
- ²⁰ Under the provisions of the IMDG Code, stowage of class 2.3 having subsidiary risk class 2.1 under deck or in enclosed ro-ro spaces is prohibited.
- ²¹ Under the provisions of the IMDG Code, stowage of class 4.3 liquids having a flashpoint less than 23°C under deck or in enclosed ro-ro spaces is prohibited.

4 Document of compliance*

The Administration shall provide the ship with an appropriate document as evidence of compliance of construction and equipment with the requirements of this regulation. Certification for dangerous goods, except solid dangerous goods in bulk, is not required for those cargoes specified as class 6.2 and 7 and dangerous goods in limited quantities and excepted quantities.

Regulation 20

Protection of vehicle, special category and ro-ro spaces

1 Purpose

The purpose of this regulation is to provide additional safety measures in order to address the fire safety objectives of this chapter for ships fitted with vehicle, special category and ro-ro spaces. For this purpose, the following functional requirements shall be met:

- .1 fire protection systems shall be provided to adequately protect the ship from the fire hazards associated with vehicle, special category and ro-ro spaces;
- .2 ignition sources shall be separated from vehicle, special category and ro-ro spaces; and
- .3 vehicle, special category and ro-ro spaces shall be adequately ventilated.

2 General requirements

2.1 Application

2.1.1 In addition to complying with the requirements of regulations in parts B, C, D and E, as appropriate, vehicle, special category and ro-ro spaces shall comply with the requirements of this regulation.

2.1.2 On all ships, vehicles with fuel in their tanks for their own propulsion may be carried in cargo spaces other than vehicle, special category or ro-ro spaces, provided that all the following conditions are met:

- .1 the vehicles do not use their own propulsion within the cargo spaces;
- .2 the cargo spaces are in compliance with the appropriate requirements of regulation 19; and
- .3 the vehicles are carried in accordance with the IMDG Code, as defined in regulation VII/1.1.

2.2 Basic principles for passenger ships

2.2.1 The basic principle underlying the provisions of this regulation is that the main vertical zoning required by regulation 9.2 may not be practicable in vehicle spaces of passenger ships and, therefore, equivalent protection must be obtained in such spaces on the basis of a horizontal zone concept and by the provision of an efficient fixed fire-extinguishing system. Based on this concept, a horizontal zone for the purpose of this regulation may include special category spaces on more than one deck provided that the total overall clear height for vehicles does not exceed 10 m.

2.2.2 The basic principle underlying the provisions of paragraph 2.2.1 is also applicable to ro-ro spaces.

2.2.3 The requirements of ventilation systems, openings in "A" class divisions and penetrations in "A" class divisions for maintaining the integrity of vertical zones in this chapter shall be applied equally to decks and bulkheads forming the boundaries separating horizontal zones from each other and from the remainder of the ship.

* Refer to *Document of compliance with the special requirements for ships carrying dangerous goods under the provisions of regulation II-2/19 of the 1974 SOLAS Convention, as amended, and paragraph 7.17 of the 2000 HSC Code, as amended (MSC.1/Circ.1266).*

3 Precaution against ignition of flammable vapours in closed vehicle spaces, closed ro-ro spaces and special category spaces

3.1 Ventilation systems*

3.1.1 Capacity of ventilation systems

There shall be provided an effective power ventilation system sufficient to give at least the following air changes:

- | | |
|---|-------------------------|
| .1 Passenger ships: | |
| Special category spaces | 10 air changes per hour |
| Closed ro-ro and vehicle spaces other than special category spaces for ships carrying more than 36 passengers | 10 air changes per hour |
| Closed ro-ro and vehicle spaces other than special category spaces for ships carrying not more than 36 passengers | 6 air changes per hour |
| .2 Cargo ships: | |
| | 6 air changes per hour |

The Administration may require an increased number of air changes when vehicles are being loaded and unloaded.

3.1.2 Performance of ventilation systems

3.1.2.1 In passenger ships, the power ventilation system shall be separate from other ventilation systems. The power ventilation system shall be operated to give at least the number of air changes required in paragraph 3.1.1 at all times when vehicles are in such spaces, except where an air quality control system in accordance with paragraph 3.1.2.4 is provided. Ventilation ducts serving such cargo spaces capable of being effectively sealed shall be separated for each such space. The system shall be capable of being controlled from a position outside such spaces.

3.1.2.2 In cargo ships, the ventilation fans shall normally be run continuously and give at least the number of air changes required in paragraph 3.1.1 whenever vehicles are on board, except where an air quality control system in accordance with paragraph 3.1.2.4 is provided. Where this is impracticable, they shall be operated for a limited period daily as weather permits and in any case for a reasonable period prior to discharge, after which period the ro-ro or vehicle space shall be proved gas free. One or more portable combustible gas detecting instruments shall be carried for this purpose. The system shall be entirely separate from other ventilation systems. Ventilation ducts serving ro-ro or vehicle spaces shall be capable of being effectively sealed for each cargo space. The system shall be capable of being controlled from a position outside such spaces.

3.1.2.3 The ventilation system shall be such as to prevent air stratification and the formation of air pockets.

3.1.2.4 For all ships, where an air quality control system is provided based on the guidelines developed by the Organization,[†] the ventilation system may be operated at a decreased number of air changes and/or a decreased amount of ventilation. This relaxation does not apply to spaces to which at least 10 air changes per hour is required by paragraph 3.2.2 of this regulation and spaces subject to regulations 19.3.4.1 and 20-1.

3.1.3 Indication of ventilation systems

Means shall be provided on the navigation bridge to indicate any loss of the required ventilating capacity.

* Refer to *Design guidelines and operational recommendations for ventilation systems in ro-ro cargo spaces* (MSC/Circ.729).

† Refer to the *Revised design guidelines and operational recommendations for ventilation systems in ro-ro cargo spaces* (MSC/Circ.1515).

3.1.4 Closing appliances and ducts

3.1.4.1 Arrangements shall be provided to permit a rapid shutdown and effective closure of the ventilation system from outside of the space in case of fire, taking into account the weather and sea conditions.

SEE INTERPRETATION 36

3.1.4.2 Ventilation ducts, including dampers, within a common horizontal zone shall be made of steel. In passenger ships, ventilation ducts that pass through other horizontal zones or machinery spaces shall be "A-60" class steel ducts constructed in accordance with regulations 9.7.2.4.1.1 and 9.7.2.4.1.2.

3.1.5 Permanent openings

Permanent openings in the side plating, the ends or deckhead of the space shall be so situated that a fire in the cargo space does not endanger stowage areas and embarkation stations for survival craft and accommodation spaces, service spaces and control stations in superstructures and deckhouses above the cargo spaces.

3.2 Electrical equipment and wiring

3.2.1 Except as provided in paragraph 3.2.2, electrical equipment and wiring shall be of a type suitable for use in an explosive petrol and air mixture.*

3.2.2 In case of other than special category spaces below the bulkhead deck, notwithstanding the provisions in paragraph 3.2.1, above a height of 450 mm from the deck and from each platform for vehicles, if fitted, except platforms with openings of sufficient size permitting penetration of petrol gases downwards, electrical equipment of a type so enclosed and protected as to prevent the escape of sparks shall be permitted as an alternative, on condition that the ventilation system is so designed and operated as to provide continuous ventilation of the cargo spaces at the rate of at least 10 air changes per hour whenever vehicles are on board.

3.3 Electrical equipment and wiring in exhaust ventilation ducts

Electrical equipment and wiring, if installed in an exhaust ventilation duct, shall be of a type approved for use in explosive petrol and air mixtures and the outlet from any exhaust duct shall be sited in a safe position, having regard to other possible sources of ignition.

3.4 Other ignition sources

Other equipment which may constitute a source of ignition of flammable vapours shall not be permitted.

3.5 Scuppers and discharges

Scuppers shall not be led to machinery or other spaces where sources of ignition may be present.

4 Detection and alarm

4.1 Fixed fire detection and fire alarm systems

Except as provided in paragraph 4.3.1, there shall be provided a fixed fire detection and fire alarm system complying with the requirements of the Fire Safety Systems Code. The fixed fire detection system shall be capable of rapidly detecting the onset of fire. The type of detectors and their spacing and location shall be to the satisfaction of the Administration, taking into account the effects of ventilation and other relevant factors. After being installed, the system shall be tested under normal ventilation conditions and shall give an overall response time to the satisfaction of the Administration.

* Refer to the recommendations of the International Electrotechnical Commission, in particular publication IEC 60079, *Electrical apparatus for explosive gas atmospheres*.

4.2 Sample extraction smoke detection systems

Except open ro-ro spaces, open vehicle spaces and special category spaces, a sample extraction smoke detection system complying with the requirements of the Fire Safety Systems Code may be used as an alternative for the fixed fire detection and fire alarm system required in paragraph 4.1.

4.3 Special category spaces

4.3.1 An efficient fire patrol system shall be maintained in special category spaces. If an efficient fire patrol system is maintained by a continuous fire watch at all times during the voyage, a fixed fire detection and fire alarm system is not required.

4.3.2 Manually operated call points shall be spaced so that no part of the space is more than 20 m from a manually operated call point, and one shall be placed close to each exit from such spaces.

5 Structural fire protection

Notwithstanding the provisions of regulation 9.2.2, in passenger ships carrying more than 36 passengers, the boundary bulkheads and decks of special category spaces and ro-ro spaces shall be insulated to "A-60" class standard. However, where a category (5), (9) or (10) space, as defined in regulation 9.2.2.3, is on one side of the division, the standard may be reduced to "A-0". Where fuel oil tanks are below a special category space or a ro-ro space, the integrity of the deck between such spaces may be reduced to "A-0" standard.

6 Fire extinction

6.1 Fixed fire-extinguishing systems

(The requirements of paragraphs 6.1.1 and 6.1.2 shall apply to ships constructed on or after 1 July 2014. Ships constructed before 1 July 2014 shall comply with the previously applicable requirements of paragraphs 6.1.1 and 6.1.2)

6.1.1 Vehicle spaces and ro-ro spaces, which are not special category spaces and are capable of being sealed from a location outside of the cargo spaces, shall be fitted with one of the following fixed fire-extinguishing systems:

- .1 a fixed gas fire-extinguishing system complying with the provisions of the Fire Safety Systems Code;
- .2 a fixed high-expansion foam fire-extinguishing system complying with the provisions of the Fire Safety Systems Code; or
- .3 a fixed water-based fire-fighting system for ro-ro spaces and special category spaces complying with the provisions of the Fire Safety Systems Code and paragraphs 6.1.2.1 to 6.1.2.4.

6.1.2 Vehicle spaces and ro-ro spaces not capable of being sealed and special category spaces shall be fitted with a fixed water-based fire-fighting system for ro-ro spaces and special category spaces complying with the provisions of the Fire Safety Systems Code which shall protect all parts of any deck and vehicle platform in such spaces. Such a water-based fire-fighting system shall have:

- .1 a pressure gauge on the valve manifold;
- .2 clear marking on each manifold valve indicating the spaces served;
- .3 instructions for maintenance and operation located in the valve room; and
- .4 a sufficient number of drainage valves to ensure complete drainage of the system.

6.1.3 The Administration may permit the use of any other fixed fire-extinguishing system* that has been shown, by a full-scale test in conditions simulating a flowing petrol fire in a vehicle space or a ro-ro space, to be not less effective in controlling fires likely to occur in such a space.

6.1.4 The requirement of this paragraph shall apply to ships constructed on or after 1 January 2010. Ships constructed on or after 1 July 2002 and before 1 January 2010 shall comply with the previously applicable requirements of paragraph 6.1.4, as adopted by resolution MSC.99(73). When fixed pressure water-spraying systems are fitted, in view of the serious loss of stability which could arise due to large quantities of water accumulating on the deck or decks during the operation of the fixed pressure water-spraying system, the following arrangements shall be provided:

- .1** in passenger ships:
 - .1.1** in the spaces above the bulkhead deck, scuppers shall be fitted so as to ensure that such water is rapidly discharged directly overboard, taking into account the guidelines developed by the Organization;†
 - .1.2.1** in ro-ro passenger ships, discharge valves for scuppers, fitted with positive means of closing operable from a position above the bulkhead deck in accordance with the requirements of the International Convention on Load Lines in force, shall be kept open while the ships are at sea;
 - .1.2.2** any operation of valves referred to in paragraph 6.1.4.1.2.1 shall be recorded in the logbook;
 - .1.3** in the spaces below the bulkhead deck, the Administration may require pumping and drainage facilities to be provided additional to the requirements of regulation II-1/35-1. In such case, the drainage system shall be sized to remove no less than 125% of the combined capacity of both the water-spraying system pumps and the required number of fire hose nozzles, taking into account the guidelines developed by the Organization.† The drainage system valves shall be operable from outside the protected space at a position in the vicinity of the extinguishing system controls. Bilge wells shall be of sufficient holding capacity and shall be arranged at the side shell of the ship at a distance from each other of not more than 40 m in each watertight compartment;
- .2** in cargo ships, the drainage and pumping arrangements shall be such as to prevent the build-up of free surfaces. In such case, the drainage system shall be sized to remove no less than 125% of the combined capacity of both the water-spraying system pumps and the required number of fire hose nozzles, taking into account the guidelines developed by the Organization.† The drainage system valves shall be operable from outside the protected space at a position in the vicinity of the extinguishing system controls. Bilge wells shall be of sufficient holding capacity and shall be arranged at the side shell of the ship at a distance from each other of not more than 40 m in each watertight compartment. If this is not possible, the adverse effect upon stability of the added weight and free surface of water shall be taken into account to the extent deemed necessary by the Administration in its approval of the stability information.‡ Such information shall be included in the stability information supplied to the master as required by regulation II-1/5-1.

6.1.5 On all ships, for closed vehicles and ro-ro spaces and special category spaces, where fixed pressure water-spraying systems are fitted, means shall be provided to prevent the blockage of drainage arrangements, taking into account the guidelines developed by the Organization.† Ships constructed before 1 January 2010 shall comply with the requirements of this paragraph by the first survey after 1 January 2010.

* Refer to *Guidelines for the approval of fixed water-based fire-fighting systems for ro-ro spaces and special category spaces equivalent to that referred to in resolution A.123(V) (MSC.1/Circ.1272) and Revised Guidelines for the design and approval of fixed water-based fire-fighting systems for ro-ro spaces and special category spaces (MSC.1/Circ.1430)*.

† Refer to *Drainage of fire-fighting water from enclosed vehicle and ro-ro spaces and special category spaces for passenger and cargo ships (MSC.1/Circ.1234)*.

‡ Refer to *Recommendation on fixed fire-extinguishing systems for special category spaces (resolution A.123(V))*.

6.2 Portable fire extinguishers

6.2.1 Portable fire extinguishers shall be provided at each deck level in each hold or compartment where vehicles are carried, spaced not more than 20 m apart on both sides of the space. At least one portable fire extinguisher shall be located at each access to such a cargo space.*

6.2.2 In addition to the provision of paragraph 6.2.1, the following fire-extinguishing appliances shall be provided in vehicle, ro-ro and special category spaces intended for the carriage of motor vehicles with fuel in their tanks for their own propulsion:

- .1 at least three water-fog applicators; and
- .2 one portable foam applicator unit complying with the provisions of the Fire Safety Systems Code, provided that at least two such units are available in the ship for use in such spaces.

Regulation 20-1

Requirements for vehicle carriers carrying motor vehicles with compressed hydrogen or natural gas in their tanks for their own propulsion as cargo

SEE INTERPRETATION 4

1 Purpose

The purpose of this regulation is to provide additional safety measures in order to address the fire safety objectives of this chapter for vehicle carriers with vehicle and ro-ro spaces intended for carriage of motor vehicles with compressed hydrogen or compressed natural gas in their tanks for their own propulsion as cargo.

2 Application

2.1 In addition to complying with the requirements of regulation 20, as appropriate, vehicle carriers constructed on or after 1 January 2016 intended for the carriage of motor vehicles with compressed hydrogen or compressed natural gas in their tanks for their own propulsion as cargo shall comply with the requirements in paragraphs 3 to 5 of this regulation.

2.2 In addition to complying with the requirements of regulation 20, as appropriate, vehicle carriers constructed before 1 January 2016, including those constructed before 1 July 2012,[†] shall comply with the requirements in paragraph 5 of this regulation.

3 Requirements for spaces intended for carriage of motor vehicles with compressed natural gas in their tanks for their own propulsion as cargo

3.1 Electrical equipment and wiring

All electrical equipment and wiring shall be of a certified safe type for use in an explosive methane and air mixture.[‡]

3.2 Ventilation arrangement

3.2.1 Electrical equipment and wiring, if installed in any ventilation duct, shall be of a certified safe type for use in explosive methane and air mixtures.

3.2.2 The fans shall be such as to avoid the possibility of ignition of methane and air mixtures. Suitable wire mesh guards shall be fitted over inlet and outlet ventilation openings.

* Refer to *Unified interpretation of SOLAS chapter II-2 on the number and arrangement of portable fire extinguishers on board ships* (MSC.1/Circ.1275 and its Corr.1).

[†] Refer to *Recommendation on safety measures for existing vehicle carriers carrying motor vehicles with compressed hydrogen or natural gas in their tanks for their own propulsion as cargo* (MSC.1/Circ.1471).

[‡] Refer to the recommendations of the International Electrotechnical Commission, in particular, publication IEC 60079.

3.3 Other ignition sources

Other equipment which may constitute a source of ignition of methane and air mixtures shall not be permitted.

4 Requirements for spaces intended for carriage of motor vehicles with compressed hydrogen in their tanks for their own propulsion as cargo

4.1 Electrical equipment and wiring

All electrical equipment and wiring shall be of a certified safe type for use in an explosive hydrogen and air mixture.*

4.2 Ventilation arrangement

4.2.1 Electrical equipment and wiring, if installed in any ventilation duct, shall be of a certified safe type for use in explosive hydrogen and air mixtures and the outlet from any exhaust duct shall be sited in a safe position, having regard to other possible sources of ignition.

4.2.2 The fans shall be designed such as to avoid the possibility of ignition of hydrogen and air mixtures. Suitable wire mesh guards shall be fitted over inlet and outlet ventilation openings.

4.3 Other ignition sources

Other equipment which may constitute a source of ignition of hydrogen and air mixtures shall not be permitted.

5 Detection

When a vehicle carrier carries as cargo one or more motor vehicles with either compressed hydrogen or compressed natural gas in their tanks for their own propulsion, at least two portable gas detectors shall be provided. Such detectors shall be suitable for the detection of the gas fuel and be of a certified safe type for use in the explosive gas and air mixture.

Regulation 21

Casualty threshold, safe return to port and safe areas

1 Application

Passenger ships constructed on or after 1 July 2010 having a length, as defined in regulation II-1/2.5, of 120 m or more or having three or more main vertical zones shall comply with the provisions of this regulation.

2 Purpose

The purpose of this regulation is to establish design criteria for a ship's safe return to port under its own propulsion after a casualty that does not exceed the casualty threshold stipulated in paragraph 3 and also provides functional requirements and performance standards for safe areas.

3 Casualty threshold

The casualty threshold, in the context of a fire, includes:

- .1 loss of space of origin up to the nearest "A" class boundaries, which may be a part of the space of origin, if the space of origin is protected by a fixed fire-extinguishing system; or
- .2 loss of the space of origin and adjacent spaces up to the nearest "A" class boundaries which are not part of the space of origin.

* Refer to the recommendations of the International Electrotechnical Commission, in particular, publication IEC 60079.

4 Safe return to port*

SEE INTERPRETATIONS 37 AND 38

When fire damage does not exceed the casualty threshold indicated in paragraph 3, the ship shall be capable of returning to port while providing a safe area as defined in regulation 3.51. To be deemed capable of returning to port, the following systems shall remain operational in the remaining part of the ship not affected by fire:

- .1 propulsion;
- .2 steering systems and steering-control systems;
- .3 navigational systems;
- .4 systems for fill, transfer and service of fuel oil;

SEE INTERPRETATION 39

- .5 internal communication between the bridge, engineering spaces, safety centre, fire-fighting and damage-control teams, and as required for passenger and crew notification and mustering;
- .6 external communication;

SEE INTERPRETATION 40

- .7 fire main system;
- .8 fixed fire-extinguishing systems;
- .9 fire and smoke detection system;
- .10 bilge and ballast system;
- .11 power-operated watertight and semi-watertight doors;
- .12 systems intended to support "safe areas" as indicated in paragraph 5.1.2;
- .13 flooding detection systems; and

SEE INTERPRETATION 41

- .14 other systems determined by the Administration to be vital to damage control efforts.

5 Safe area(s)

5.1 Functional requirements

- .1 the safe area(s) shall generally be an internal space(s); however, the use of an external space as a safe area may be allowed by the Administration taking into account any restriction due to the area of operation and relevant expected environmental conditions;
- .2 the safe area(s) shall provide all occupants with the following basic services* to ensure that the health of passengers and crew is maintained:
 - .1 sanitation;
 - .2 water;
 - .3 food;
 - .4 alternate space for medical care;
 - .5 shelter from the weather;

* Refer to *Interim Explanatory Notes for the assessment of passenger ship systems' capabilities after a fire or flooding casualty* (MSC.1/Circ.1369/Add.1).

- .6 means of preventing heat stress and hypothermia;
 - .7 light; and
 - .8 ventilation;
- .3 ventilation design shall reduce the risk of smoke and hot gases that could affect the use of the safe area(s); and
- .4 means of access to life-saving appliances shall be provided from each area identified or used as a safe area, taking into account that a main vertical zone may not be available for internal transit.

5.2 Alternate space for medical care

Alternate space for medical care shall conform to a standard acceptable to the Administration.*

Regulation 22

Design criteria for systems to remain operational after a fire casualty

1 Application

Passenger ships constructed on or after 1 July 2010 having a length, as defined in regulation II-1/2.5, of 120 m or more or having three or more main vertical zones shall comply with the provisions of this regulation.

2 Purpose

The purpose of this regulation is to provide design criteria for systems required to remain operational for supporting the orderly evacuation and abandonment of a ship, if the casualty threshold, as defined in regulation 21.3, is exceeded.

3 Systems[†]

3.1 In case any one main vertical zone is unserviceable due to fire, the following systems shall be so arranged and segregated as to remain operational:

- .1 fire main;
- .2 internal communications (in support of fire fighting as required for passenger and crew notification and evacuation);
- .3 means of external communications;
- .4 bilge systems for removal of fire-fighting water;
- .5 lighting along escape routes, at assembly stations and at embarkation stations of life-saving appliances; and
- .6 guidance systems for evacuation shall be available.

3.2 The above systems shall be capable of operation for at least 3 h based on the assumption of no damage outside the unserviceable main vertical zone. These systems are not required to remain operational within the unserviceable main vertical zones.

3.3 Cabling and piping within a trunk constructed to an "A-60" standard shall be deemed to remain intact and serviceable while passing through the unserviceable main vertical zone for the purposes of paragraph 3.1. An equivalent degree of protection for cabling and piping may be approved by the Administration.

* Refer to *Guidance on the establishment of medical and sanitation related programmes for passenger ships* (MSC/Circ.1129).

[†] Refer to *Interim Explanatory Notes for the assessment of passenger ship systems' capabilities after a fire or flooding casualty* (MSC.1/Circ.1369).

Regulation 23

Safety centre on passenger ships

1 Application

Passenger ships constructed on or after 1 July 2010 shall have on board a safety centre complying with the requirements of this regulation.

2 Purpose

The purpose of this regulation is to provide a space to assist with the management of emergency situations.

3 Location and arrangement

The safety centre shall either be a part of the navigation bridge or be located in a separate space adjacent, but having direct access, to the navigation bridge, so that the management of emergencies can be performed without distracting watch officers from their navigational duties.

4 Layout and ergonomic design

The layout and ergonomic design of the safety centre shall take into account the guidelines developed by the Organization,* as appropriate.

5 Communications

Means of communication between the safety centre, the central control station, the navigation bridge, the engine control room, the storage room(s) for fire-extinguishing system(s) and fire equipment lockers shall be provided.

6 Control and monitoring of safety systems

Notwithstanding the requirements set out elsewhere in the Convention, the full functionality (operation, control, monitoring or any combination thereof, as required) of the safety systems listed below shall be available from the safety centre:

- .1 all powered ventilation systems;
- .2 fire doors;
- .3 general emergency alarm system;
- .4 public address system;
- .5 electrically powered evacuation guidance systems;
- .6 watertight and semi-watertight doors;
- .7 indicators for shell doors, loading doors and other closing appliances;
- .8 water leakage of inner/outer bow doors, stern doors and any other shell door;
- .9 television surveillance system;
- .10 fire detection and alarm system;
- .11 fixed fire-fighting local application system(s);
- .12 sprinkler and equivalent systems;

* Refer to the guidelines to be developed by the Organization.

- .13 water-based fire-extinguishing systems for machinery spaces;
- .14 alarm to summon the crew;
- .15 atrium smoke extraction system;
- .16 flooding detection systems; and
- .17 fire pumps and emergency fire pumps.

Unified Interpretations for Chapter II-2

II-2

- 1 Repairs, alterations, modifications and outfitting** (Source: MSC-MEPC.2/Circ.10)
- Reg. 1.3 For single-hull oil tanker conversion into double-hull oil tanker or bulk carrier, new and converted parts should comply with the latest applicable requirements.
- 2 Definitions** (Source: MSC.1/Circ.1434)
- Reg. 3.2.3 Insulated "A" class bulkheads and decks used on board ships, including the means of affixing the insulation to the "A" class structural members, should be consistent with the materials, details and arrangements used during, and documented in the test reports issued for, the approval test for that insulating material.
- 3 Deadweight to be stated on certificates** (Source: MSC.1/Circ.1573)
- Reg. 3.21 Even-keel hydrostatics should be used to determine the regulatory deadweight to be entered on relevant statutory certificates.
- 4 Definition of vehicle carrier** (Source: MSC.1/Circ.1555)
- Regs. 3.56, 20-1 The definition of vehicle carrier in SOLAS regulation II-2/3.56 is intended for pure car and truck carriers, and should exclude other types of ro-ro cargo ships or container/ro-ro ships, even when carrying empty cars and trucks as cargo.
- 5 Application of materials other than steel on engine, turbine and gearbox installations** (Source: MSC.1/Circ.1527)
- Reg. 4 Materials other than steel may be assessed in relation to the risk of fire associated with the component and its installation. The use of materials other than steel is considered acceptable for the following applications:
- .1 internal pipes which cannot cause any release of flammable fluid onto the machinery or into the machinery space in case of failure; or
 - .2 components that are only subject to liquid spray on the inside when the machinery is running, such as machinery covers, rocker box covers, camshaft end covers, inspection plates and sump tanks. It is a condition that the pressure inside these components and all the elements contained therein is less than 0.18 N/mm² and that wet sumps have a volume not exceeding 100 litres; or
 - .3 components attached to machinery which satisfy fire test criteria according to standard ISO 19921:2005/19922:2005 or other standards acceptable to the Administration, and which retain mechanical properties adequate for the intended installation.
- 6 Location of entrances, air inlets and openings in the superstructures and/or deckhouses of oil and chemical tankers and gas carriers** (Source: MSC.1/Circ.1459)
- Regs. 4.5.2.1, 4.5.2.2, 4.5.3.4.1, 11.6.2 and 16.3.2.3 If, under the requirements of the SOLAS Convention, the IBC Code or the IGC Code, owing to the design of a ship, it is impossible in practice, or unreasonable, to fulfil the requirements relating to the location of access doors, air inlets or other openings in superstructures and/or deckhouses, the Administration or recognized organization acting on its behalf may adopt alternative provisions provided that, as a consequence of doing so, no ignition source is located in the hazardous areas defined in publication IEC 60092-502, except for electrical installations that have the required protection and have been certified as safe under that standard.
- 7 Inert gas supply to double-hull spaces** (Source: MSC.1/Circ.1555)
- Reg. 4.5.5.1 Double-hull spaces required to be fitted with suitable connections for the supply of inert gas as per SOLAS regulation II-2/4.5.5.1.4.1 are all ballast tanks and void spaces of double-hull and double-bottom spaces adjacent to the cargo tanks, including the forepeak tank and any other tanks and spaces under the bulkhead deck adjacent to cargo tanks, except cargo pump-rooms and ballast pump-rooms.

8 Gas measurement and detection – portable instruments (Source: MSC.1/Circ.1456)

Reg. 4.5.7.1 The requirement of regulation II-2/4.5.7.1 for one portable instrument for measuring oxygen and one for measuring flammable vapour concentrations, and spares for both, should be considered as being satisfied when a minimum of two instruments, each capable of measuring both oxygen and flammable vapour concentrations are provided on board. Alternatively, two portable instruments for measuring oxygen and two portable instruments for measuring flammable vapour concentrations could be provided on board.

9 Gas measurement and detection – portable instruments (Source: MSC.1/Circ.1581)

Reg. 4.5.7.1 9.1 Compliance with the provision "suitable means shall be provided for the calibration of such instruments" in SOLAS regulation II-2/4.5.7.1, as adopted by resolution MSC.291(87), may be achieved by portable atmosphere testing instruments being calibrated on board or ashore in accordance with the manufacturer's instructions.

9.2 For the avoidance of any doubt, the above consideration refers to the calibration of portable instruments for measuring oxygen or flammable vapour concentrations, as required by SOLAS regulation II-2/4.5.7.1, and not to any pre-operational accuracy tests as recommended by the manufacturer.

10 Arrangements for fixed hydrocarbon gas detection systems in double-hull and double-bottom spaces of oil tankers (Source: MSC.1/Circ.1527)

Reg. 4.5.7.3.1 10.1 The term "cargo tanks" in the phrase "spaces adjacent to the cargo tanks" includes slop tanks except those arranged for the storage of oily water only.

10.2 The term "spaces" in the phrase "spaces under the bulkhead deck adjacent to cargo tanks" includes dry compartments such as ballast pump-rooms and bow thruster rooms and any tanks such as freshwater tanks, but excludes fuel oil tanks.

10.3 The term "adjacent" in the phrase "adjacent to the cargo tanks" includes ballast tanks, void spaces, other tanks or compartments located below the bulkhead deck located adjacent to cargo tanks and includes any spaces or tanks located below the bulkhead deck which form a cruciform (corner to corner) contact with the cargo tanks.

11 Closing appliances and stopping devices of ventilation (Source: MSC.1/Circ.1434)

Reg. 5.2.1.1 11.1 Battery room ventilators should be fitted with a means of closing whenever:

- .1 the battery room does not open directly onto an exposed deck;
- .2 the ventilation opening for the battery room is required to be fitted with a closing device according to the Load Line Convention (i.e. the height of the opening does not extend to more than 4.5 m (14.8 feet) above the deck for position 1 or to more than 2.3 m (7.5 feet) above the deck in position 2; or
- .3 the battery room is fitted with a fixed gas fire-extinguishing system.

11.2 Where a battery room ventilator is fitted with a closing device, then a warning notice stating, for example "This closing device is to be kept open and only closed in the event of fire or other emergency – Explosive gas", should be provided at the closing device to mitigate the possibility of inadvertent closing.

12 Ventilation by fan coil units and internal circulation fans (Source: MSC.1/Circ.1555)

Regs. 5.2.1.2, 5.2.1.3, 7.9.3 The fan in a heat, ventilation and air conditioning (HVAC) temperature control unit, or a circulation fan inside a cabinet/switchboard, is not considered to be a ventilation fan as addressed in SOLAS regulations II-2/5.2.1.2, II-2/5.2.1.3 and II-2/7.9.3, if it is not capable of supplying outside air to the space when the power ventilation is shut down (e.g. small units intended for recirculation of air within a cabin). Therefore, such fans need not be capable of being stopped from an easily accessible position (or a safe position) outside the space being served when applying SOLAS regulations II-2/5.2.1.2 or II-2/5.2.1.3, and need not be capable of being controlled from a continuously manned central control station for passenger ships carrying more than 36 passengers when applying SOLAS regulation II-2/7.9.3.

13 Control stations on cargo ships – application to cargo ships (Source: MSC.1/Circ.1456)

Reg. 7.5.5 As no reference to control stations is made for any of the protection methods provided in accordance with SOLAS regulations II-2/7.5.5.1, 7.5.5.2 and 7.5.5.3, control stations on cargo ships do not need to be covered by a fixed fire detection and fire alarm system.

14 Bulkhead between the wheelhouse and toilet inside the wheelhouse (Source: MSC.1/Circ.1555)

Reg. 9 A bulkhead separating the wheelhouse and the toilet, installed completely within the wheelhouse, requires no fire rating.

15 Containment of fire, thermal and structural boundaries (Source: MSC.1/Circ.1616)

Reg. 9.2 In cases where urea or sodium hydroxide solution tanks for selective catalytic reduction (SCR) systems, exhaust gas recirculation (EGR) systems or exhaust gas cleaning systems (EGCS) are installed in a space separated from the engine-room, in determining fire integrity of divisions, the solution tank space should be considered as "similar spaces" in the definition of "machinery spaces" in regulation 3.30 and should be categorized as:

"(10) Tanks, voids and auxiliary machinery spaces having little or no fire risk" in regulation 9.2.2.3.2.2, for ships carrying more than 36 passengers; or

"(7) Other machinery spaces" in regulations 9.2.2.4.2.2, 9.2.3.3.2.2 or 9.2.4.2.2.2, for ships carrying not more than 36 passengers and cargo ships.

The division between the engine-room and the solution tank space should have a fire integrity of at least "A-0" class.

16 Thermal and structural boundaries (Source: MSC.1/Circ.1581)

Regs. 9.2.2.4.2, 9.2.3.3.2, 9.2.4.2.2 A navigation locker that can only be accessed from the wheelhouse should be considered as a control station with respect to the requirements in tables 9.3, 9.5 and 9.7 of regulation 9, and the bulkhead separating the wheelhouse and such a locker should have fire integrity of at least "B-0" class.

17 Containment of fire (Source: MSC.1/Circ.1511)

Reg. 9 17.1 Decks and bulkheads

(Tables 9.5 and 9.6)

Decks and bulkheads to be insulated to "A-30" fire integrity are those boundaries of single spaces protected by their own fire-extinguishing system.

17.2 Hatches

Class "A" fire integrity respectively does not apply to hatches fitted on open deck adjacent to ro-ro/vehicle spaces and on decks separating ro-ro/vehicle spaces, provided that such hatches are constructed of steel.

17.3 Access doors

"A-0" fire integrity does not apply to access doors to ro-ro/vehicle spaces fitted on open decks, provided that such access doors are constructed of steel.

17.4 Movable ramps

Movable ramps installed on decks referred to in Interpretation 17.1 above which form boundaries of "A-30" fire integrity shall be constructed of steel and shall be insulated to "A-30" fire integrity, except for the "working parts" of such movable ramps (e.g. hydraulic cylinders, associated pipes/accessories) and members supporting such fittings which do not contribute to the structural strength of the boundary. Such movable ramps need not be subject to fire test. This is applicable to non-watertight doors used for loading/unloading of vehicles.

17.5 Ventilation ducts

Where ducts for a ro-ro/vehicle spaces pass through other ro-ro/vehicle spaces without serving those spaces, each duct shall be insulated all along itself to "A-30" fire integrity in ways of other ro-ro/vehicle spaces unless the sleeves and fire dampers in compliance with SOLAS regulation II-2/9.7.3.1 in order to prevent spread of fire through the ducts are fitted.

17.6 Ventilators

"A-0" fire integrity does not apply to ventilators constructed of steel fitted on open decks adjacent to ro-ro/vehicle spaces.

18 Non-combustible material as “steel or equivalent” for ventilation ducts (Sources: MSC.1/Circ.1527; MSC.1/Circ.1480)

Reg. 9.7.1.1 18.1 With respect to SOLAS regulation II-2/9.7.1.1, a ventilation duct made of material other than steel may be considered equivalent to a ventilation duct made of steel, provided the material is non-combustible and has passed a standard fire test in accordance with annex 1 to part 3 of the 2010 FTP Code as a non-load bearing structure for 30 min, following the requirements for testing “B” class divisions.

18.2 A short length, not exceeding 600 mm, of flexible bellows constructed of combustible material may be used for connecting fans to the ducting in air-conditioning rooms.

19 Containment of fire, ventilation systems, exhaust ducts from galley ranges (Source: MSC.1/Circ.1616)

Reg. 9.7.5 19.1 The reference to ISO 15371:2009 in the footnote to both regulations 9.7.5.1.1.3 and 9.7.5.2.4 is given as an example of a suitable performance standard for pre-engineered galley duct fixed fire-extinguishing systems.

19.2 CO₂ fire-extinguishing systems, which are not pre-engineered fixed fire-extinguishing systems, should be designed according to the requirements set out in regulation 10.6.3.1.1 (spaces containing flammable liquids) or another suitable standard acceptable to the Administration.

20 Fire fighting, Carriage of dangerous goods (Source: MSC.1/Circ.1550)

Regs. 10.2.1.3, 10.2.2.4.1.2, 10.7.3.2.3, 19.3.1 20.1 On board cargo ships designed to carry five or more tiers of containers on or above the weather deck:

- .1 in cases where the mobile water monitors are supplied by separate pumps and piping system, the total capacity of the main fire pumps need not exceed 180 m³/h and the diameter of the fire main and water service pipes (hereinafter referred to “the pipework diameter”) need only be sufficient for the discharge of 140 m³/h;
- .2 in cases where the mobile water monitors are supplied by the main fire pumps; the total capacity of required main fire pumps and the pipework diameter should be sufficient for simultaneously supplying both the required number of fire hoses and mobile water monitors. However, the total capacity should not be less than the following sub-paragraphs .1 or .2, whichever is smaller:
 - .1 four thirds of the quantity required under regulation II-1/35-1 to be dealt with by each of the independent bilge pumps in a passenger ship of the same dimension when employed in bilge pumping; or
 - .2 180 m³/h;
- .3 in cases where the mobile water monitors and the “water spray system” (fixed arrangement of spraying nozzles or flooding the cargo space with water) required by SOLAS regulation II-2/19.3.1.3 are supplied by the main fire pumps, the total capacity of the main fire pumps and the pipework diameter need only be sufficient to supply whichever of the following is the greater:
 - .1 the mobile water monitors and the four nozzles required by SOLAS regulation II-2/19.3.1.2; or
 - .2 the four nozzles required by SOLAS regulation II-2/19.3.1.2 and the water spray system required by SOLAS regulation II-2/19.3.1.3.

The total capacity, however, should not be less than the capacity required in paragraph 20.1.2.1 or 20.1.2.2, whichever is smaller.

20.2 On board cargo ships designed to carry five or more tiers of containers on or above the weather deck, the total capacity of the emergency fire pump need not exceed 72 m³/h.

21 Suction and discharge piping of emergency fire pumps which are run through the machinery space (Source: MSC.1/Circ.1456)

Reg. 10.2.1.4.1 21.1 “The valve” in the second sentence means “sea inlet valve”.

21.2 In cases where suction or discharge piping penetrating machinery spaces are enclosed in a substantial steel casing, or are insulated to “A-60” class standards, it is not necessary to enclose or insulate “distance pieces”, “sea inlet valves” and “sea-chests”. For this purpose, the discharge piping means piping between the emergency fire pump and the isolating valve.

21.3 The method for insulating pipes to “A-60” class standards” is that they are to be covered/protected in a practical manner by insulation material which is approved as a part of “A 60” class divisions in accordance with the FTP Code.

21.4 Where the sea inlet valve is in the machinery space, the valve should not be a fail-close type. Where the sea inlet valve is in the machinery space and is not a fail-open type, measures should be taken so that the valve can be opened in the event of fire, e.g. control piping, actuating devices and/or electric cables with fire-resistant protection equivalent to "A-60" class standards.

21.5 In cases where main fire pumps are provided in compartments outside machinery spaces and where the emergency fire pump suction or discharge piping penetrates such compartments, the above interpretation should be applied to the piping.

22 Location of the fire main isolation valves (Source: MSC.1/Circ.1456, as amended)
in tankers

Reg.
10.2.1.4.4

The complete interpretation of the phrase "the isolation valves shall be fitted in the fire main at the poop front in a protected position" would be that the valve should be located within an accommodation space, service spaces or control station. However, the valve may be located on the open deck aft of the cargo area provided that the valve is located:

- .1 at least 5 m aft of the aft end of the aftermost cargo tank; or
- .2 if the above .1 is not practical, within 5 m aft of the aft end of the aftermost cargo tank provided the valve is protected by a permanent steel obstruction.

23 Deep-fat cooking equipment (Source: MSC.1/Circ.1433)

Reg. 10.6.4.1 With regard to the footnote to SOLAS regulation II-2/10.6.4.1, referring to the recommendations by the International Organization for Standardization, it should be interpreted as follows:

"Refer to the recommendations by the International Organization for Standardization, in particular publication ISO 15371:2009, *Ships and marine technology – Fire-extinguishing systems for protection of galley cooking equipment*. For ships constructed before 1 July 2013, ISO 15371:2000, *Ships and marine technology – Fire extinguishing systems for protection of galley deep-fat cooking equipment – Fire tests*, may be used."

24 Application of carbon dioxide or inert system (Source: MSC.1/Circ.1456)
for self-heating solid bulk cargoes

Regs.
10.7.1.3,
10.7.2

This self-heating phenomenon should be regarded as an emergency condition such that it is not necessary to provide a separate fixed carbon dioxide fire-extinguishing system or inert gas system dedicated to the control of the self-heating of the cargo within the cargo holds. The fixed carbon dioxide or inert gas fire-extinguishing system complying with the provisions of the FSS Code required by SOLAS regulation II-2/10.7.1.3 or II-2/10.7.2 may be used for this purpose. Fixed gas fire-extinguishing systems or inert gas systems installed on board dedicated exclusively to the protection of spaces other than cargo spaces should not be used for this purpose.

25 Fire-fighter's communication (Source: MSC.1/Circ.1616)

Reg. 10.10.4 25.1 Two-way portable radiotelephone apparatus for fire-fighter's communication required by regulation 10.10.4 should be of certified safe type suitable for use in zone 1 hazardous areas, as defined in IEC Publication 60079.

25.2 The minimum requirements in respect to the apparatus group and temperature class are to be consistent with the most restrictive requirements for the hazardous area zone on board which is accessible to fire party.

26 Emergency exit hatches to open deck (Source: MSC.1/Circ.1456)

Reg. 13.1

To facilitate a swift and safe means of escape to the lifeboat and liferaft embarkation deck, the following provisions should apply to overhead hatches fitted along the escape routes addressed by regulation II-2/13:

- .1 the securing devices should be of a type which can be opened from both sides;
- .2 the maximum force needed to open the hatch cover should not exceed 150 N; and
- .3 the use of a spring equalizing, counterbalance or other suitable device on the hinge side to reduce the force needed for opening is acceptable.

27 Means of escape in cargo ships (Source: MSC.1/Circ.1511)

Regs.
13.3.3.2,
13.3.3.3

The "Lowest open deck" should be a category (10) "Open deck" (as defined in SOLAS chapter II-2, regulations 9.2.3.3.2.2 and 9.2.4.2.2.2) at the lowest height from baseline in way of accommodation spaces.

28 Means of escape on passenger ships

(Source: MSC.1/Circ.1511)

Reg. 13.4.1

28.1 A "safe position" can be any space, excluding lockers and storerooms irrespective of their area, cargo spaces and spaces where flammable liquids are stowed, but including special category spaces and ro-ro spaces, from which access is provided and maintained clear of obstacles to the embarkation decks (regulations II-2/13.4.1.1.1 and 13.4.1.4).

28.2 Inclined ladders/stairways in machinery spaces being part of, or providing access to, escape routes but not located within a protected enclosure should not have an inclination greater than 60° and should not be less than 600 mm in clear width. Such requirement need not be applied to ladders/stairways not forming part of an escape route, only provided for access to equipment or components, or similar areas, from one of the main platforms or deck levels within such spaces (regulation II-2/13.4.1).

28.3 Machinery spaces may include working platforms and passageways, or intermediate decks at more than one deck level. In such case, the lower part of the space should be regarded as the lowest deck level, platform or passageway within the space. At deck levels, other than the lowest one, where only one means of escape other than the protected enclosure is provided, self-closing fire doors should be fitted in the protected enclosure at that deck level. Smaller working platforms in-between deck levels, or only for access to equipment or components, need not be provided with two means of escape (regulation II-2/13.4.1.1).

28.4 A protected enclosure providing escape from machinery spaces to an open deck may be fitted with a hatch as means of egress from the enclosure to the open deck. The hatch should have minimum internal dimensions of 800 mm × 800 mm (regulation II-2/13.4.1.1.1).

28.5 Internal dimensions should be interpreted as clear width, so that a passage having diameter of 800 mm is available throughout the vertical enclosure, as shown in figure 1, clear of ship's structure, with insulation and equipment, if any. The ladder within the enclosure can be included in the internal dimensions of the enclosure. When protected enclosures include horizontal portions their clear width should not be less than 600 mm. Figure 1 is given as example of some possible arrangements which may be in line with the above interpretation (regulation II-2/13.4.1.1.1).

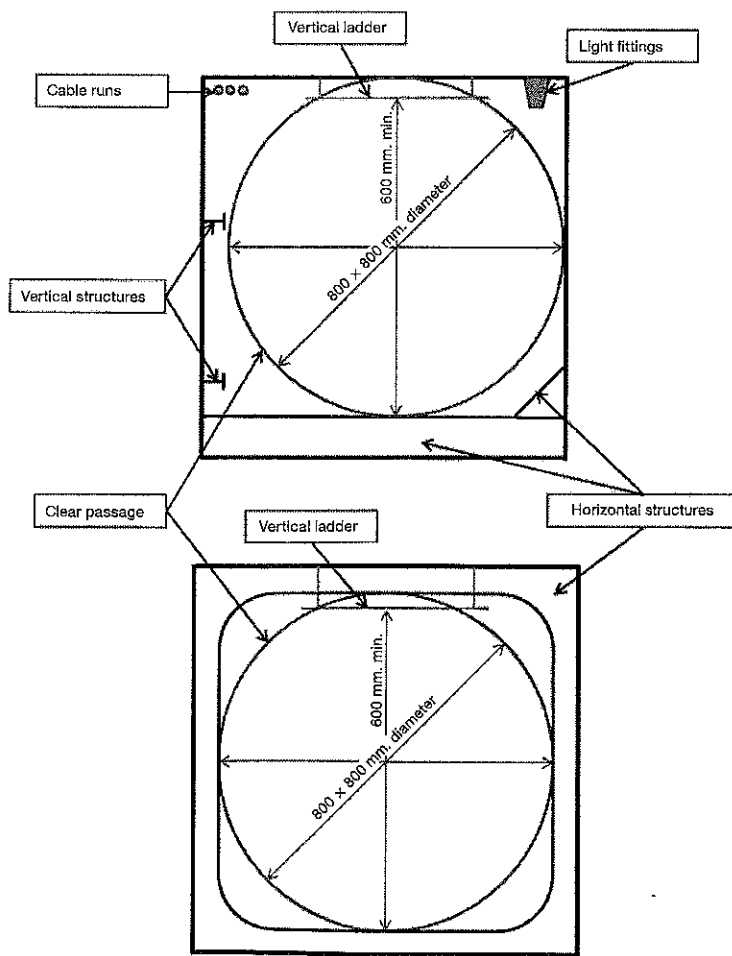

Figure 1

**29 Means of escape on passenger ships
Means of escape on cargo ships**

(Source: MSC.1/Circ.1511)

Regs.
13.4.1.4,
13.4.1.6,
13.4.2.5,
13.4.2.6

29.1 Main workshop

A "main workshop" means a compartment enclosed on at least three sides by bulkheads or gratings, usually containing welding equipment, metal working machinery and workbenches.

29.2 Machinery control rooms

A "machinery control room" means a space which serves for control and/or monitoring of machinery used for ship's main propulsion.

29.3 Continuous fire shelter

A "continuous fire shelter" means a route from a main workshop, or from a machinery control room, which allows safe escape, without entering the machinery space, to a location outside the machinery space. Such a continuous fire shelter need not be a protected enclosure as envisaged by SOLAS regulation II-2/13.4.1.1 or II-2/13.4.2.1.1. The boundaries of the continuous fire shelter shall be at least "A-0" class divisions and be protected by self closing "A-0" class doors. The continuous fire shelter shall have minimum internal dimensions of at least 800 mm x 800 mm for vertical trunks and 600 mm in width for horizontal trunks, and shall have emergency lighting provisions. Figures 2 to 7 represent typical arrangements of the continuous fire shelters through trunks or through spaces/rooms to a location outside the machinery space, which should be considered as effective.

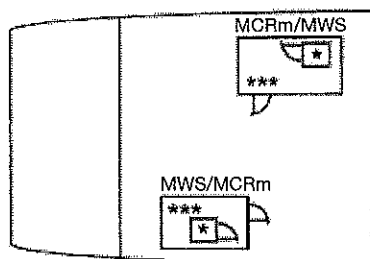

Figure 2 – Single room escape via trunk

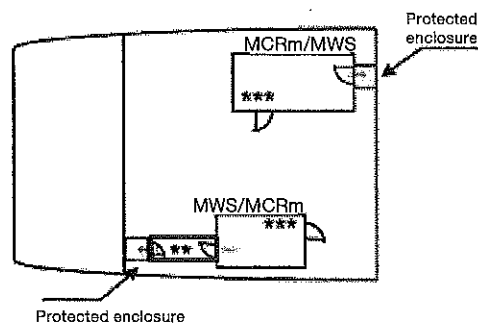

Figure 3 – Single room escape via protected enclosure

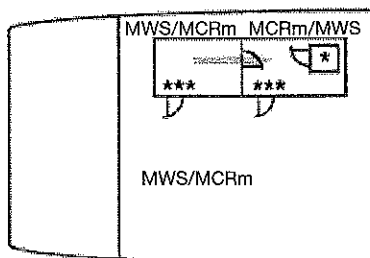

Figure 4 – Room to room escape via trunk

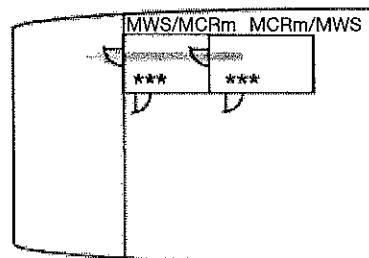

Figure 5 – Room to room direct escape

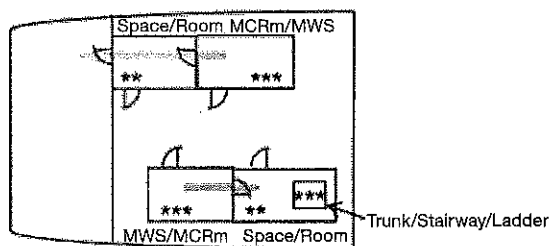

Figure 6 – Room to room escape via trunk

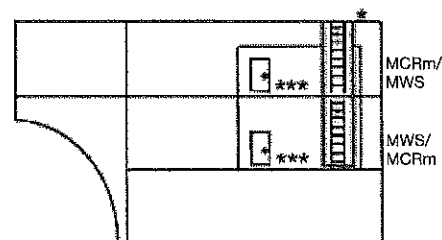

Figure 7 – Room to room other space/room

MCRm: Machinery Control Room
MWS: Main Workshop

* Vertical trunk (minimum dimensions: 800 mm x 800 mm) enclosing ladders or stairways to be at least "A-0" class divisions and to be protected by self-closing "A-0" class doors

** Horizontal trunk (minimum width: 600 mm) to be at least "A-0" class divisions and to be protected by self-closing "A-0" class doors

*** Fire integrity not required

30 Means of escape on cargo ships

(Source: MSC.1/Circ.1511)

Reg. 13.4.2

30.1 A "safe position" can be any space, excluding cargo spaces, lockers and storerooms irrespective of their area, cargo pump-rooms and spaces where flammable liquids are stowed, but including vehicle and ro-ro spaces, from which access is provided and maintained clear of obstacles to the open deck (regulation II-2/13.4.2.1.1).

30.2 Inclined ladders/stairways in machinery spaces being part of, or providing access to, escape routes, but not located within a protected enclosure should not have an inclination greater than 60° and should not be less than 600 mm in clear width. Such requirement need not be applied to ladders/stairways not forming part of an escape route, only provided for access to equipment or components, or similar areas, from one of the main platforms or deck levels within such spaces (regulation II-2/13.4.2.1).

30.3 Machinery spaces of category A may include working platforms and passageways, or intermediate decks at more than one deck level. In such case, the lower part of the space should be regarded as the lowest deck level, platform or passageway within the space.

At deck levels, other than the lowest one, where only one means of escape other than the protected enclosure is provided, self-closing fire doors should be fitted in the protected enclosure at that deck level. Smaller working platforms in-between deck levels, or only for access to equipment or components, need not be provided with two means of escape (regulation II-2/13.4.2.1).

30.4 A protected enclosure providing escape from machinery spaces of category A to an open deck may be fitted with a hatch as means of egress from the enclosure to the open deck. The hatch should have minimum internal dimensions of 800 mm × 800 mm (regulation II-2/13.4.2.1.1).

30.5 Internal dimensions should be interpreted as clear width, so that a passage having diameter of 800 mm is available throughout the vertical enclosure, as shown in figure 8, clear of ship's structure, with insulation and equipment, if any. The ladder within the enclosure can be included in the internal dimensions of the enclosure. When protected enclosures include horizontal portions their clear width should not be less than 600 mm. Figure 8 is given as example of some possible arrangements which may be in line with the above interpretation (regulation II-2/13.4.2.1.1).

30.6 In machinery spaces other than those of category A, which are not entered only occasionally, the travel distance should be measured from any point normally accessible to the crew, taking into account machinery and equipment within the space (regulation II 2/13.4.2.3).

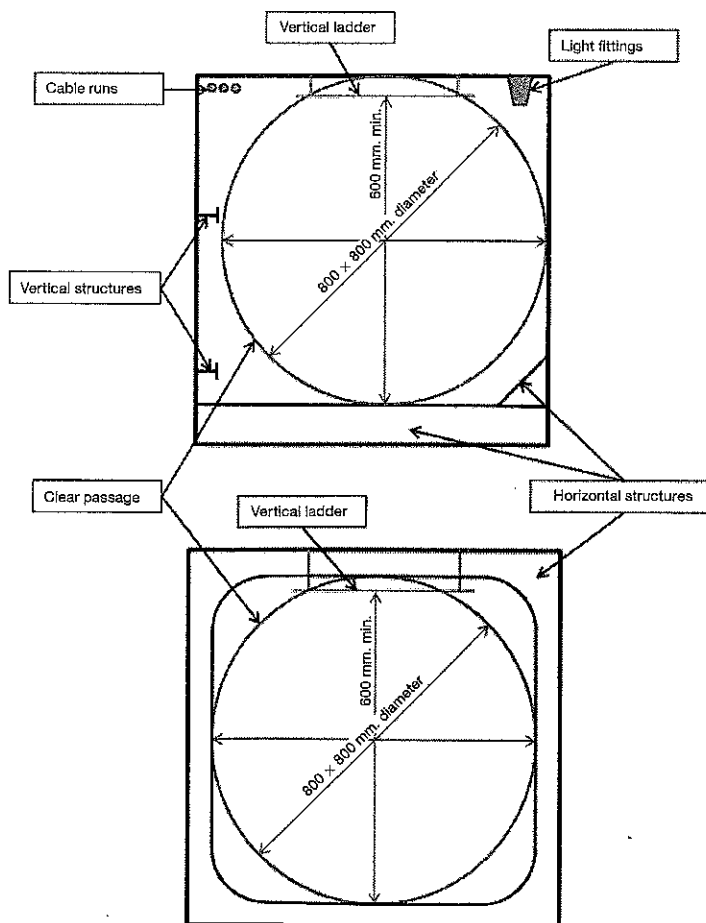

Figure 8

31 Means of escape from ro-ro spaces*(Source: MSC.1/Circ.1505)*

Reg. 13.6

31.1 A place where the crew are present to carry out their routine work duties, e.g. during the loading and unloading of a ro-ro deck, or during their ro-ro deck inspections whilst the ship is underway, is considered normally employed.

31.2 Ro-ro deck inspections could for instance include: fire patrols, inspection of the cargo, check of bilge wells and their alarms, sounding of tanks, cargo deck cleaning, different types of maintenance work (removing of rust, painting, greasing, etc.).

31.3 Ro-ro spaces should be fitted with at least two means of escape, one located at the fore end and the other at the aft end of the space, from which access is provided to the lifeboat and liferaft embarkation decks. One of the means of escape should be a stairway, the second escape may be a trunk or a stairway.

31.4 The fore and aft ends of the ro-ro space are considered as the areas being within the distance equal to the breadth of the ro-ro space, measured at its widest point, from its forward most and aftmost point.

31.5 Suitable signs and markings should be provided to indicate the route to the means of escape.

32 Suitable number of spare air cylinders to be provided in connection with drills*(Source: MSC.1/Circ.1555)*

Reg. 15.2.2.6

32.1 "A suitable number of spare cylinders" to be carried on board to replace those used for fire drills should be at least one "set of cylinders" for each mandatory breathing apparatus, unless additional spare cylinders are required by the shipboard safety management system (SMS).

32.2 "Set of cylinders" means the number of cylinders which are required to operate the breathing apparatus.

32.3 No additional cylinders are required for fire drills for breathing apparatus sets required by SOLAS regulation II-2/19, IMSBC Code, the IBC Code or IGC Code.

33 Products requiring oxygen-dependent inhibitors*(Source: MSC.1/Circ.1501)*Regs.
16.3.3.2,
16.3.3.3

When a product containing an oxygen-dependent inhibitor is carried on a ship for which inerting is required under SOLAS chapter II-2, the inert gas system shall be operated as required to maintain the oxygen level in the vapour space of the tank at or above the minimum level of oxygen required under paragraph 15.13 of the IBC Code and as specified in the Certificate of Protection.

34 Certified safe type electrical equipment for ships carrying dangerous goods*(Source: MSC.1/Circ.1555)*

Reg. 19.3.2

34.1 Reference should be made to IEC 60092-506:2003 standard, *Electrical installations in ships – Part 506: Special features – Ships carrying specific dangerous goods and materials hazardous only in bulk*.

34.2 For pipes having open ends (e.g. ventilation and bilge pipes) in a hazardous area, the pipe itself should be classified as a hazardous area (see IEC 60092-506:2003 table B1, item B).

34.3 When carrying flammable liquids having flashpoints less than 23°C as Class 3, Class 6.1 or Class 8 in cargo spaces, the bilge pipes with flanges, valves, pumps, etc. constitute a source of release and the enclosing spaces (e.g. pipe tunnels, bilge pump-rooms) should be classified as an extended hazardous area (comparable with zone 2) unless these spaces are continuously mechanically ventilated with a capacity for at least six air changes per hour. Except where the space is protected with redundant mechanical ventilation capable of starting automatically, equipment not certified for zone 2 should be automatically disconnected following loss of ventilation while essential systems such as bilge and ballast systems should be certified for zone 2. Where redundant mechanical ventilation is employed, equipment and essential systems not certified for zone 2 should be interlocked so as to prevent inadvertent operation if the ventilation is not operational. Audible and visible alarms should be provided at a manned station if failure occurs.

35 Ventilation*(Source: MSC.1/Circ.1434)*

Reg. 19.3.4

35.1 If adjacent spaces are not separated from cargo spaces by gastight bulkheads or decks, then they should be considered as part of the enclosed cargo space and the ventilation requirements should apply to the adjacent space as for the enclosed cargo space itself.

35.2 Where the IMSBC Code requires:

- .1 two fans per hold, a common ventilation system with two fans connected is acceptable; and
- .2 continuous ventilation, this does not prohibit ventilators from being fitted with a means of closure as required for fire protection purposes under SOLAS regulation II-2/5.2.1.1, provided the minimum height to the ventilator opening is to be in accordance with regulation 19.3 of the 1966 International Convention on Load Lines (4.5 m for position 1 and 2.3 m for position 2).

36 Closing appliances and ducts

(Source: MSC.1/Circ.1434)

Reg. 20.3.1.4.1

36.1 Access routes to the controls for closure of the ventilation system "permit a rapid shutdown" and adequately "take into account the weather and sea conditions" if the routes:

- .1 are clearly marked and at least 600 mm in clear width;
- .2 are provided with a single handrail or wire rope lifeline not less than 10 mm in diameter, supported by stanchions not more than 10 m apart in way of any route which involves traversing a deck exposed to weather; and
- .3 are fitted with appropriate means of access (such as ladders or steps) to the closing devices of ventilators located in high positions (i.e. 1.8 m and above).

36.2 Alternatively, remote closing and position indicator arrangements from the bridge or a fire control station for those ventilator closures is acceptable.

37 Fire and flooding casualty, pipes and vent ducts

(Source: MSC.1/Circ.1437)

Reg. 21.4

All pipes and vent ducts passing through (not serving) a compartment affected by a flooding casualty are considered to remain operational provided they, together with relevant fittings, are capable of withstanding the head of water expected at their location.

38 Fire and flooding casualty, electrical cables

(Source: MSC.1/Circ.1437)

Reg. 21.4

Electrical cables complying with standard IEC 60092-359 may be considered to remain operational in a space affected by a flooding casualty, provided they have no connections, no joints, no equipment connected to them, etc., within such space or such connections, joints and devices have a degree of protection IPX8 in accordance with standard IEC 60529 (head of water expected at their location for a period not inferior to that estimated for the safe return to port).

39 Systems for fill, transfer and service of fuel oil

(Source: MSC.1/Circ.1437)

Reg. 21.4.4

Systems for internal fill, transfer and service of:

- .1 fuel;
- .2 other flammable hydrocarbons; or
- .3 any fluid that may be flammable or dangerous if heated to a very high temperature (both within the pipe and ongoing through pumps, orifices or other equipment),

should be established as being capable of remaining operational when crossing flooded watertight compartments, considering in particular consequences of low seawater temperature on liquids behaviour.

40 External communications

(Source: MSC.1/Circ.1437)

Reg. 21.4.6

40.1 Portable radiocommunication equipment might be accepted; and

40.2 charging capability for any portable devices should be available in more than one main vertical zone (MVZ).

41 Safe return to port

(Source: MSC.1/Circ.1539/Rev.1)

Reg. 21.4.13

For passenger ships carrying 36 or more persons and subject to SOLAS regulation II-1/8-1, the safe return to port (SRTP) requirements of SOLAS regulation II-2/21.4 apply to both:

- .1 the flooding detection systems in the spaces as defined in paragraph 6 of MSC.1/Circ.1291; and
- .2 the liquid level monitoring systems, which are used as, or replace, the flooding detection systems, as specified in paragraph 7 of MSC.1/Circ.1291.

Therefore, for systems noted in sub-paragraph .2 above, the phrase "excluded from these requirements" in paragraph 7 of MSC.1/Circ.1291 is not an exclusion from the general provision in SOLAS regulation II-2/21.4.13 (remain operational in the event of fire). This exclusion pertains only to the detailed provisions in MSC.1/Circ.1291.

Chapter III

Life-saving appliances and arrangements



Chapter III

Life-saving appliances and arrangements

Part A	General	
Regulation 1	Application	289
Regulation 2	Exemptions	290
Regulation 3	Definitions	290
Regulation 4	Evaluation, testing and approval of life-saving appliances and arrangements	292
Regulation 5	Production tests	292
Part B	Requirements for ships and life-saving appliances	
Section I	<i>Passenger ships and cargo ships</i>	
Regulation 6	Communications	293
Regulation 7	Personal life-saving appliances	295
Regulation 8	Muster list and emergency instructions	296
Regulation 9	Operating instructions	296
Regulation 10	Manning of survival craft and supervision	296
Regulation 11	Survival craft muster and embarkation arrangements	297
Regulation 12	Launching stations	298
Regulation 13	Stowage of survival craft	298
Regulation 14	Stowage of rescue boats	299
Regulation 15	Stowage of marine evacuation systems	299
Regulation 16	Survival craft launching and recovery arrangements	299
Regulation 17	Rescue boat embarkation, launching and recovery arrangements	300
Regulation 17-1	Recovery of persons from the water	301
Regulation 18	Line-throwing appliances	301
Regulation 19	Emergency training and drills	301
Regulation 20	Operational readiness, maintenance and inspections	304
Section II	<i>Passenger ships (additional requirements)</i>	
Regulation 21	Survival craft and rescue boats	307
Regulation 22	Personal life-saving appliances	309
Regulation 23	Survival craft and rescue boat embarkation arrangements	310
Regulation 24	Stowage of survival craft	310
Regulation 25	Muster stations	310
Regulation 26	Additional requirements for ro-ro passenger ships	310
Regulation 27	Information on passengers	312

Regulation 28	Helicopter landing and pick-up areas	313
Regulation 29	Decision support system for masters of passenger ships	313
Regulation 30	Drills	314
Section III	<i>Cargo ships (additional requirements)</i>	
Regulation 31	Survival craft and rescue boats	314
Regulation 32	Personal life-saving appliances	316
Regulation 33	Survival craft embarkation and launching arrangements	317
Section IV	<i>Life-saving appliances and arrangements requirements</i>	
Regulation 34	[untitled]	317
Section V	<i>Miscellaneous</i>	
Regulation 35	Training manual and on-board training aids	317
Regulation 36	Instructions for on-board maintenance	318
Regulation 37	Muster list and emergency instructions	318
Part C	<i>Alternative design and arrangements</i>	
Regulation 38	Alternative design and arrangements	320
Unified Interpretations for Chapter III	323

Part A

General

Regulation 1

Application

- 1 Unless expressly provided otherwise, this chapter shall apply to ships the keels of which are laid or which are at a similar stage of construction on or after 1 July 1998.
- 2 For the purpose of this chapter the term a *similar stage of construction* means the stage at which:
 - .1 construction identifiable with a specific ship begins; and
 - .2 assembly of that ship has commenced comprising at least 50 tonnes or 1% of the estimated mass of all structural material, whichever is less.
- 3 For the purpose of this chapter:
 - .1 the expression *ships constructed* means "ships the keels of which are laid or which are at a similar stage of construction";
 - .2 the expression *all ships* means ships constructed before, on or after 1 July 1998; the expressions *all passenger ships* and *all cargo ships* shall be construed accordingly;
 - .3 a cargo ship, whenever built, which is converted to a passenger ship shall be treated as a passenger ship constructed on the date on which such a conversion commences.
- 4 For ships constructed before 1 July 1998, the Administration shall:
 - .1 ensure that, subject to the provisions of paragraph 4.2, the requirements which are applicable under chapter III of the International Convention for the Safety of Life at Sea, 1974, in force prior to 1 July 1998 to new or existing ships as prescribed by that chapter are complied with;
 - .2 ensure that when life-saving appliances or arrangements on such ships are replaced or such ships undergo repairs, alterations or modifications of a major character which involve replacement of, or any addition to, their existing life-saving appliances or arrangements, such life-saving appliances or arrangements, in so far as is reasonable and practicable, comply with the requirements of this chapter. However, if a survival craft other than an inflatable liferaft is replaced without replacing its launching appliance, or vice versa, the survival craft or launching appliance may be of the same type as that replaced; and

SEE INTERPRETATION 1

- .3 ensure that the requirements of regulations 30.3 and 37.3.9 are complied with.

5 Notwithstanding paragraph 4.2, for all ships, not later than the first scheduled dry-docking after 1 July 2014, but not later than 1 July 2019, lifeboat on-load release mechanisms not complying with paragraphs 4.4.7.6.4 to 4.4.7.6.6 of the Code shall be replaced with equipment that complies with the International Life-Saving Appliance (LSA) Code.*

SEE INTERPRETATION 2

* Refer to *Guidelines for evaluation and replacement of lifeboat release and retrieval systems* (MSC.1/Circ.1392 and its Corr.1, as amended by MSC.1/Circ.1584).

Regulation 2 Exemptions

- 1 The Administration may, if it considers that the sheltered nature and conditions of the voyage are such as to render the application of any specific requirements of this chapter unreasonable or unnecessary, exempt from those requirements individual ships or classes of ships which, in the course of their voyage, do not proceed more than 20 miles from the nearest land.
- 2 In the case of passenger ships which are employed in special trades for the carriage of large numbers of special trade passengers, such as the pilgrim trade, the Administration, if satisfied that it is impracticable to enforce compliance with the requirements of this chapter, may exempt such ships from those requirements, provided that such ships comply fully with the provisions of:
 - .1 the rules annexed to the Special Trade Passenger Ships Agreement, 1971; and
 - .2 the rules annexed to the Protocol on Space Requirements for Special Trade Passenger Ships, 1973.

Regulation 3 Definitions

For the purpose of this chapter, unless expressly provided otherwise:

- 1 *Anti-exposure suit* is a protective suit designed for use by rescue boat crews and marine evacuation system parties.
- 2 *Certificated person* is a person who holds a certificate of proficiency in survival craft issued under the authority of, or recognized as valid by, the Administration in accordance with the requirements of the International Convention on Standards of Training, Certification and Watchkeeping for Seafarers, in force; or a person who holds a certificate issued or recognized by the Administration of a State not a Party to that Convention for the same purpose as the convention certificate.
- 3 *Detection* is the determination of the location of survivors or survival craft.
- 4 *Embarkation ladder* is the ladder provided at survival craft embarkation stations to permit safe access to survival craft after launching.
- 5 *Float-free launching* is that method of launching a survival craft whereby the craft is automatically released from a sinking ship and is ready for use.
- 6 *Free-fall launching* is that method of launching a survival craft whereby the craft with its complement of persons and equipment on board is released and allowed to fall into the sea without any restraining apparatus.
- 7 *Immersion suit* is a protective suit which reduces the body heat loss of a person wearing it in cold water.
- 8 *Inflatable appliance* is an appliance which depends upon non-rigid, gas-filled chambers for buoyancy and which is normally kept uninflated until ready for use.
- 9 *Inflated appliance* is an appliance which depends upon non-rigid, gas-filled chambers for buoyancy and which is kept inflated and ready for use at all times.
- 10 *International Life-Saving Appliance (LSA) Code* (referred to as "the Code" in this chapter) means the International Life-Saving Appliance (LSA) Code adopted by the Maritime Safety Committee of the Organization by resolution MSC.48(66), as it may be amended by the Organization, provided that such amendments are adopted, brought into force and take effect in accordance with the provisions of article VIII of the present Convention concerning the amendment procedures applicable to the annex other than chapter I.
- 11 *Launching appliance or arrangement* is a means of transferring a survival craft or rescue boat from its stowed position safely to the water.

12 *Length* is 96% of the total length on a waterline at 85% of the least moulded depth measured from the top of the keel, or the length from the fore-side of the stem to the axis of the rudder stock on that waterline, if that be greater. In ships designed with a rake of keel the waterline on which this is measured shall be parallel to the designed waterline.

13 *Lightest seagoing condition* is the loading condition with the ship on even keel, without cargo, with 10% stores and fuel remaining and in the case of a passenger ship with the full number of passengers and crew and their luggage.

14 *Marine evacuation system* is an appliance for the rapid transfer of persons from the embarkation deck of a ship to a floating survival craft.

15 *Moulded depth*

- .1** The *moulded depth* is the vertical distance measured from the top of the keel to the top of the freeboard deck beam at side. In wood and composite ships the distance is measured from the lower edge of the keel rabbet. Where the form at the lower part of the midship section is of a hollow character, or where thick garboards are fitted, the distance is measured from the point where the line of the flat of the bottom continued inwards cuts the side of the keel.
- .2** In ships having rounded gunwales, the *moulded depth* shall be measured to the point of intersection of the moulded lines of the deck and side shell plating, the lines extending as though the gunwale were of angular design.
- .3** Where the freeboard deck is stepped and the raised part of the deck extends over the point at which the moulded depth is to be determined, the *moulded depth* shall be measured to a line of reference extending from the lower part of the deck along a line parallel with the raised part.

16 *Novel life-saving appliance or arrangement* is a life-saving appliance or arrangement which embodies new features not fully covered by the provisions of this chapter or the Code but which provides an equal or higher standard of safety.

17 *Positive stability* is the ability of a craft to return to its original position after the removal of a heeling moment.

18 *Recovery time* for a rescue boat is the time required to raise the boat to a position where persons on board can disembark to the deck of the ship. Recovery time includes the time required to make preparations for recovery on board the rescue boat such as passing and securing a painter, connecting the rescue boat to the launching appliance, and the time to raise the rescue boat. Recovery time does not include the time needed to lower the launching appliance into position to recover the rescue boat.

19 *Rescue boat* is a boat designed to rescue persons in distress and to marshal survival craft.

20 *Retrieval* is the safe recovery of survivors.

21 *Ro-ro passenger ship* means a passenger ship with ro-ro cargo spaces or special category spaces as defined in regulation II-2/3.

22 *Short international voyage* is an international voyage in the course of which a ship is not more than 200 miles from a port or place in which the passengers and crew could be placed in safety. Neither the distance between the last port of call in the country in which the voyage begins and the final port of destination nor the return voyage shall exceed 600 miles. The final port of destination is the last port of call in the scheduled voyage at which the ship commences its return voyage to the country in which the voyage began.

23 *Survival craft* is a craft capable of sustaining the lives of persons in distress from the time of abandoning the ship.

24 *Thermal protective aid* is a bag or suit made of waterproof material with low thermal conductance.

25 *Requirements for maintenance, thorough examination, operational testing, overhaul and repair* means the Requirements for maintenance, thorough examination, operational testing, overhaul and repair of lifeboats

and rescue boats, launching appliances and release gear, adopted by the Maritime Safety Committee of the Organization by resolution MSC.402(96), as may be amended by the Organization, provided that such amendments are adopted, brought into force and take effect in accordance with the provisions of article VIII of the present Convention concerning the amendment procedures applicable to the annex other than chapter I.

Regulation 4

Evaluation, testing and approval of life-saving appliances and arrangements

- 1 Except as provided in paragraphs 5 and 6, life-saving appliances and arrangements required by this chapter shall be approved by the Administration.
- 2 Before giving approval to life-saving appliances and arrangements, the Administration shall ensure that such life-saving appliances and arrangements:
 - .1 are tested, to confirm that they comply with the requirements of this chapter and the Code, in accordance with the recommendations of the Organization;* or
 - .2 have successfully undergone, to the satisfaction of the Administration, tests which are substantially equivalent to those specified in those recommendations.
- 3 Before giving approval to novel life-saving appliances or arrangements, the Administration shall ensure that such:
 - .1 appliances provide safety standards at least equivalent to the requirements of this chapter and the Code and have been evaluated and tested based on the guidelines developed by the Organization;† or
 - .2 arrangements have successfully undergone an engineering analysis, evaluation and approval in accordance with regulation 38.
- 4 Procedures adopted by the Administration for approval shall also include the conditions whereby approval would continue or would be withdrawn.
- 5 Before accepting life-saving appliances and arrangements that have not been previously approved by the Administration, the Administration shall be satisfied that life-saving appliances and arrangements comply with the requirements of this chapter and the Code.
- 6 Life-saving appliances required by this chapter for which detailed specifications are not included in the Code shall be to the satisfaction of the Administration.

Regulation 5

Production tests

The Administration shall require life-saving appliances to be subjected to such production tests as are necessary to ensure that the life-saving appliances are manufactured to the same standard as the approved prototype.

* Refer to *Recommendation on testing of life-saving appliances* (resolution A.689(17)). For life-saving appliances installed on board on or after 1 July 1999, refer to *Revised recommendation on testing of life-saving appliances* (resolution MSC.81(70)).

† Refer to the guidelines to be developed by the Organization.

Part B

Requirements for ships and life-saving appliances

Section I

Passenger ships and cargo ships

Regulation 6

Communications

1 Paragraph 2 applies to all passenger ships and to all cargo ships of 300 gross tonnage and upwards.

2 Radio life-saving appliances

2.1 Two-way VHF radiotelephone apparatus

2.1.1 At least three two-way VHF radiotelephone apparatus shall be provided on every passenger ship and on every cargo ship of 500 gross tonnage and upwards. At least two two-way VHF radiotelephone apparatus shall be provided on every cargo ship of 300 gross tonnage and upwards but less than 500 gross tonnage. Such apparatus shall conform to performance standards not inferior to those adopted by the Organization.* If a fixed two-way VHF radiotelephone apparatus is fitted in a survival craft it shall conform to performance standards not inferior to those adopted by the Organization.*

2.1.2 Two-way VHF radiotelephone apparatus provided on board ships prior to 1 February 1992 and not complying fully with the performance standards adopted by the Organization may be accepted by the Administration until 1 February 1999 provided the Administration is satisfied that they are compatible with approved two-way VHF radiotelephone apparatus.

2.2 Search and rescue locating devices

At least one search and rescue locating device shall be carried on each side of every passenger ship and of every cargo ship of 500 gross tonnage and upwards. At least one search and rescue locating device shall be carried on every cargo ship of 300 gross tonnage and upwards but less than 500 gross tonnage. Such search and rescue locating devices shall conform to the applicable performance standards not inferior to those adopted by the Organization.† The search and rescue locating devices‡ shall be stowed in such location that they can be rapidly placed in any survival craft other than the liferaft or liferafts required by regulation 31.1.4. Alternatively one search and rescue locating device shall be stowed in each survival craft other than those required by regulation 31.1.4. On ships carrying at least two search and rescue locating devices and equipped with free-fall lifeboats one of the search and rescue locating devices shall be stowed in a free-fall lifeboat and the other located in the immediate vicinity of the navigation bridge so that it can be utilized on board and ready for transfer to any of the other survival craft.

* Refer to *Performance standards for survival craft two-way VHF radiotelephone apparatus* (resolution A.809(19), as it may be amended, annex 1 or annex 2, as applicable), and resolution MSC.149(77).

† Refer to *Recommendation on performance standards for survival craft radar transponders for use in search and rescue operations* (resolution MSC.247(83)) (A.802(19), as amended) and *Recommendation on performance standards for survival craft AIS Search and Rescue Transmitters (AIS-SART) for use in search and rescue operations* (resolution MSC.246(83)).

‡ One of these search and rescue locating devices may be the search and rescue locating device required by regulation IV/7.1.3.

3 Distress flares

Not less than 12 rocket parachute flares, complying with the requirements of section 3.1 of the Code, shall be carried and be stowed on or near the navigation bridge.

4 On-board communications and alarm systems

SEE INTERPRETATION 3

4.1 An emergency means comprised of either fixed or portable equipment or both shall be provided for two-way communications between emergency control stations, muster and embarkation stations and strategic positions on board.

4.2 A general emergency alarm system complying with the requirements of paragraph 7.2.1 of the Code shall be provided and shall be used for summoning passengers and crew to muster stations and to initiate the actions included in the muster list. The system shall be supplemented by either a public address system complying with the requirements of paragraph 7.2.2 of the Code or other suitable means of communication. Entertainment sound systems shall automatically be turned off when the general emergency alarm system is activated.

4.3 The general emergency alarm system shall be audible throughout all the accommodation and normal crew working spaces. On passenger ships, the system shall also be audible on all open decks.

4.4 On ships fitted with a marine evacuation system communication between the embarkation station and the platform or the survival craft shall be ensured.

5 Public address systems on passenger ships

SEE INTERPRETATION 3

5.1 In addition to the requirements of regulation II-2/12.3 and of paragraph 4.2, all passenger ships shall be fitted with a public address system. With respect to passenger ships constructed before 1 July 1997 the requirements of paragraphs 5.2 and 5.4, subject to the provisions of paragraph 5.5, shall apply not later than the date of the first periodical survey after 1 July 1997.

5.2 The public address system shall be clearly audible above the ambient noise in all spaces, prescribed by paragraph 7.2.2.1 of the Code, and shall be provided with an override function controlled from one location on the navigation bridge and such other places on board as the Administration deems necessary, so that all emergency messages will be broadcast if any loudspeaker in the spaces concerned has been switched off, its volume has been turned down or the public address system is used for other purposes.

5.3 On passenger ships constructed on or after 1 July 1997:

- .1** the public address system shall have at least two loops which shall be sufficiently separated throughout their length and have two separate and independent amplifiers; and
- .2** the public address system and its performance standards shall be approved by the Administration having regard to the recommendations adopted by the Organization.*

5.4 The public address system shall be connected to the emergency source of electrical power required by regulation II-1/42.2.2.

5.5 Ships constructed before 1 July 1997 which are already fitted with the public address system approved by the Administration which complies substantially with those required by sections 5.2 and 5.4 and paragraph 7.2.2.1 of the Code are not required to change their system.

* Refer to *Recommendation on performance standards for public address systems on passenger ships, including cabling* (MSC/Circ.808).

Regulation 7

Personal life-saving appliances

1 Lifebuoys

1.1 Lifebuoys complying with the requirements of paragraph 2.1.1 of the Code shall be:

- .1 so distributed as to be readily available on both sides of the ship and as far as practicable on all open decks extending to the ship's side; at least one shall be placed in the vicinity of the stern; and
- .2 so stowed as to be capable of being rapidly cast loose, and not permanently secured in any way.

1.2 At least one lifebuoy on each side of the ship shall be fitted with a buoyant lifeline complying with the requirements of paragraph 2.1.4 of the Code equal in length to not less than twice the height at which it is stowed above the waterline in the lightest seagoing condition, or 30 m, whichever is the greater.

1.3 Not less than one half of the total number of lifebuoys shall be provided with lifebuoy self-igniting lights complying with the requirements of paragraph 2.1.2 of the Code; not less than two of these shall also be provided with lifebuoy self-activating smoke signals complying with the requirements of paragraph 2.1.3 of the Code and be capable of quick release from the navigation bridge; lifebuoys with lights and those with lights and smoke signals shall be equally distributed on both sides of the ship and shall not be the lifebuoys provided with lifelines in compliance with the requirements of paragraph 1.2.

1.4 Each lifebuoy shall be marked in block capitals of the Roman alphabet with the name and port of registry of the ship on which it is carried.

2 Lifejackets

2.1 A lifejacket complying with the requirements of paragraph 2.2.1 or 2.2.2 of the Code shall be provided for every person on board the ship and, in addition:

- .1 for passenger ships on voyages of less than 24 hours, a number of infant lifejackets equal to at least 2.5% of the number of passengers on board shall be provided;
- .2 for passenger ships on voyages of 24 hours or greater, infant lifejackets shall be provided for each infant on board;
- .3 a number of lifejackets suitable for children equal to at least 10% of the number of passengers on board shall be provided or such greater number as may be required to provide a lifejacket for each child;
- .4 a sufficient number of lifejackets shall be carried for persons on watch and for use at remotely located survival craft stations. The lifejackets carried for persons on watch should be stowed on the bridge, in the engine control room and at any other manned watch station; and
- .5 if the adult lifejackets provided are not designed to fit persons weighing up to 140 kg and with a chest girth of up to 1,750 mm, a sufficient number of suitable accessories shall be available on board to allow them to be secured to such persons.

2.2 Lifejackets shall be so placed as to be readily accessible and their position shall be plainly indicated. Where, due to the particular arrangements of the ship, the lifejackets provided in compliance with the requirements of paragraph 2.1 may become inaccessible, alternative provisions shall be made to the satisfaction of the Administration which may include an increase in the number of lifejackets to be carried.

2.3 The lifejackets used in totally enclosed lifeboats, except free-fall lifeboats, shall not impede entry into the lifeboat or seating, including operation of the seat belts in the lifeboat.

2.4 Lifejackets selected for free-fall lifeboats, and the manner in which they are carried or worn, shall not interfere with entry into the lifeboat, occupant safety or operation of the lifeboat.

3 Immersion suits and anti-exposure suits

An immersion suit, complying with the requirements of section 2.3 of the Code or an anti-exposure suit complying with section 2.4 of the Code, of an appropriate size, shall be provided for every person assigned to crew the rescue boat or assigned to the marine evacuation system party. If the ship is constantly engaged in warm climates* where, in the opinion of the Administration thermal protection is unnecessary, this protective clothing need not be carried.

Regulation 8

Muster list and emergency instructions

- 1 This regulation applies to all ships.
- 2 Clear instructions to be followed in the event of an emergency shall be provided for every person on board. In the case of passenger ships these instructions shall be drawn up in the language or languages required by the ship's flag State and in the English language.
- 3 Muster lists and emergency instructions complying with the requirements of regulation 37 shall be exhibited in conspicuous places throughout the ship including the navigation bridge, engine-room and crew accommodation spaces.
- 4 Illustrations and instructions in appropriate languages shall be posted in passenger cabins and be conspicuously displayed at muster stations and other passenger spaces to inform passengers of:
 - .1 their muster station;
 - .2 the essential actions they must take in an emergency; and
 - .3 the method of donning lifejackets.

Regulation 9

Operating instructions

- 1 This regulation applies to all ships.
- 2 Posters or signs shall be provided on or in the vicinity of survival craft and their launching controls and shall:
 - .1 illustrate the purpose of controls and the procedures for operating the appliance and give relevant instructions or warnings;
 - .2 be easily seen under emergency lighting conditions; and
 - .3 use symbols in accordance with the recommendations of the Organization.†

Regulation 10

Manning of survival craft and supervision

- 1 This regulation applies to all ships.
- 2 There shall be a sufficient number of trained persons on board for mustering and assisting untrained persons.
- 3 There shall be a sufficient number of crew members, who may be deck officers or certificated persons, on board for operating the survival craft and launching arrangements required for abandonment by the total number of persons on board.

* Refer to *Guidelines for the assessment of thermal protection* (MSC/Circ.1046).

† Refer to *Symbols related to life-saving appliances and arrangements* (resolution A.760(18), as amended by resolution MSC.82(70)).

- 4 A deck officer or certificated person shall be placed in charge of each survival craft to be used. However, the Administration, having due regard to the nature of the voyage, the number of persons on board and the characteristics of the ship, may permit persons practised in the handling and operation of liferafts to be placed in charge of liferafts in lieu of persons qualified as above. A second-in-command shall also be nominated in the case of lifeboats.
- 5 The person in charge of the survival craft shall have a list of the survival craft crew and shall see that the crew under his command are acquainted with their duties. In lifeboats the second-in-command shall also have a list of the lifeboat crew.
- 6 Every motorized survival craft shall have a person assigned who is capable of operating the engine and carrying out minor adjustments.
- 7 The master shall ensure the equitable distribution of persons referred to in paragraphs 2, 3 and 4 among the ship's survival craft.

Regulation 11

Survival craft muster and embarkation arrangements

- 1 Lifeboats and liferafts for which approved launching appliances are required shall be stowed as close to accommodation and service spaces as possible.
- 2 Muster stations shall be provided close to the embarkation stations. Each muster station shall have sufficient clear deck space to accommodate all persons assigned to muster at that station, but at least 0.35 m² per person.
- 3 Muster and embarkation stations shall be readily accessible from accommodation and work areas.
- 4 Muster and embarkation stations shall be adequately illuminated by lighting supplied from the emergency source of electrical power required by regulation II-1/42 or II-1/43, as appropriate.
- 5 Alleyways, stairways and exits giving access to the muster and embarkation stations shall be lighted. Such lighting shall be capable of being supplied by the emergency source of electrical power required by regulation II-1/42 or II-1/43, as appropriate. In addition to and as part of the markings required under regulation II-2/13.3.2.5.1, routes to muster stations shall be indicated with the muster station symbol, intended for that purpose, in accordance with the recommendations of the Organization.*
- 6 Davit-launched and free-fall launched survival craft muster and embarkation stations shall be so arranged as to enable stretcher cases to be placed in survival craft.
- 7 An embarkation ladder complying with the requirements of paragraph 6.1.6 of the Code extending, in a single length, from the deck to the waterline in the lightest seagoing condition under all conditions of trim of up to 10° and a list of up to 20° either way shall be provided at each embarkation station or at every two adjacent embarkation stations for survival craft launched down the side of the ship. However, the Administration may permit such ladders to be replaced by approved devices to afford access to the survival craft when waterborne, provided that there shall be at least one embarkation ladder on each side of the ship. Other means of embarkation enabling descent to the water in a controlled manner may be permitted for the liferafts required by regulation 31.1.4.
- 8 Where necessary, means shall be provided for bringing the davit-launched survival craft against the ship's side and holding them alongside so that persons can be safely embarked.

* Refer to *Symbols related to life-saving appliances and arrangements* (resolution A.760(18), as amended by resolution MSC.82(70)), and to *Guidelines for the evaluation, testing and application of low-location lighting on passenger ships* (resolution A.752(18)).

Regulation 12 *Launching stations*

Launching stations shall be in such positions as to ensure safe launching having particular regard to clearance from the propeller and steeply overhanging portions of the hull and so that, as far as possible, survival craft, except survival craft specially designed for free-fall launching, can be launched down the straight side of the ship. If positioned forward, they shall be located abaft the collision bulkhead in a sheltered position and, in this respect, the Administration shall give special consideration to the strength of the launching appliance.

Regulation 13 *Stowage of survival craft*

- 1 Each survival craft shall be stowed:
 - .1 so that neither the survival craft nor its stowage arrangements will interfere with the operation of any other survival craft or rescue boat at any other launching station;
 - .2 as near the water surface as is safe and practicable and, in the case of a survival craft other than a liferaft intended for throw-overboard launching, in such a position that the survival craft in the embarkation position is not less than 2 m above the waterline with the ship in the fully loaded condition under unfavourable conditions of trim of up to 10° and listed up to 20° either way, or to the angle at which the ship's weather deck edge becomes submerged, whichever is less;
 - .3 in a state of continuous readiness so that two crew members can carry out preparations for embarkation and launching in less than 5 min;
 - .4 fully equipped as required by this chapter and the Code; and
 - .5 as far as practicable, in a secure and sheltered position and protected from damage by fire and explosion. In particular, survival craft on tankers, other than the liferafts required by regulation 31.1.4, shall not be stowed on or above a cargo tank, slop tank, or other tank containing explosive or hazardous cargoes.
- 2 Lifeboats for lowering down the ship's side shall be stowed as far forward of the propeller as practicable. On cargo ships of 80 m in length and upwards but less than 120 m in length, each lifeboat shall be so stowed that the after end of the lifeboat is not less than the length of the lifeboat forward of the propeller. On cargo ships of 120 m in length and upwards and passenger ships of 80 m in length and upwards, each lifeboat shall be so stowed that the after end of the lifeboat is not less than 1.5 times the length of the lifeboat forward of the propeller. Where appropriate, the ship shall be so arranged that lifeboats, in their stowed positions, are protected from damage by heavy seas.
- 3 Lifeboats shall be stowed attached to launching appliances.
 - 4.1 Every liferaft shall be stowed with its painter permanently attached to the ship.
 - 4.2 Each liferaft or group of liferafts shall be stowed with a float-free arrangement complying with the requirements of paragraph 4.1.6 of the Code so that each floats free and, if inflatable, inflates automatically when the ship sinks.
 - 4.3 Liferafts shall be so stowed as to permit manual release of one raft or container at a time from their securing arrangements.
 - 4.4 Paragraphs 4.1 and 4.2 do not apply to liferafts required by regulation 31.1.4.
- 5 Davit-launched liferafts shall be stowed within reach of the lifting hooks, unless some means of transfer is provided which is not rendered inoperable within the limits of trim and list prescribed in paragraph 1.2 or by ship motion or power failure.

6 Liferafts intended for throw-overboard launching shall be so stowed as to be readily transferable for launching on either side of the ship unless liferafts, of the aggregate capacity required by regulation 31.1 to be capable of being launched on either side, are stowed on each side of the ship.

Regulation 14

Stowage of rescue boats

Rescue boats shall be stowed:

- .1 in a state of continuous readiness for launching in not more than 5 min, and, if the inflated type, in a fully inflated condition at all times;
- .2 in a position suitable for launching and recovery;
- .3 so that neither the rescue boat nor its stowage arrangements will interfere with the operation of any survival craft at any other launching station; and
- .4 if it is also a lifeboat, in compliance with the requirements of regulation 13.

Regulation 15

Stowage of marine evacuation systems

1 The ship's side shall not have any openings between the embarkation station of the marine evacuation system and the waterline in the lightest seagoing condition and means shall be provided to protect the system from any projections.

SEE INTERPRETATION 4

2 Marine evacuation systems shall be in such positions as to ensure safe launching having particular regard to clearance from the propeller and steeply overhanging positions of the hull and so that, as far as practicable, the system can be launched down the straight side of the ship.

3 Each marine evacuation system shall be stowed so that neither the passage nor platform nor its stowage or operational arrangements will interfere with the operation of any other life-saving appliance at any other launching station.

4 Where appropriate, the ship shall be so arranged that the marine evacuation systems in their stowed positions are protected from damage by heavy seas.

Regulation 16

Survival craft launching and recovery arrangements

1 Unless expressly provided otherwise, launching and embarkation appliances complying with the requirements of section 6.1 of the Code shall be provided for all survival craft except those which are:

- .1 boarded from a position on deck less than 4.5 m above the waterline in the lightest seagoing condition and which have a mass of not more than 185 kg; or
- .2 boarded from a position on deck less than 4.5 m above the waterline in the lightest seagoing condition and which are stowed for launching directly from the stowed position under unfavourable conditions of trim of up to 10° and list of up to 20° either way; or
- .3 carried in excess of the survival craft for 200% of the total number of persons on board the ship and which have a mass of not more than 185 kg; or

- .4 carried in excess of the survival craft for 200% of the total number of persons on board the ship, are stowed for launching directly from the stowed position under unfavourable conditions of trim of up to 10° and list of up to 20° either way; or
 - .5 provided for use in conjunction with a marine evacuation system, complying with the requirements of section 6.2 of the Code and stowed for launching directly from the stowed position under unfavourable conditions of trim of up to 10° and list of up to 20° either way.
- 2 Each lifeboat shall be provided with an appliance which is capable of launching and recovering the lifeboat. In addition there shall be provision for hanging-off the lifeboat to free the release gear for maintenance.
 - 3 Launching and recovery arrangements shall be such that the appliance operator on the ship is able to observe the survival craft at all times during launching and for lifeboats during recovery.
 - 4 Only one type of release mechanism shall be used for similar survival craft carried on board the ship.
 - 5 Preparation and handling of survival craft at any one launching station shall not interfere with the prompt preparation and handling of any other survival craft or rescue boat at any other station.
 - 6 Falls, where used, shall be long enough for the survival craft to reach the water with the ship in its lightest seagoing condition, under unfavourable conditions of trim of up to 10° and list of up to 20° either way.
 - 7 During preparation and launching, the survival craft, its launching appliance, and the area of water into which it is to be launched shall be adequately illuminated by lighting supplied from the emergency source of electrical power required by regulation II-1/42 or II-1/43, as appropriate.
 - 8 Means shall be available to prevent any discharge of water onto survival craft during abandonment.
 - 9 If there is a danger of the survival craft being damaged by the ship's stabilizer wings, means shall be available, powered by an emergency source of energy, to bring the stabilizer wings inboard; indicators operated by an emergency source of energy shall be available on the navigating bridge to show the position of the stabilizer wings.
 - 10 If partially enclosed lifeboats complying with the requirements of section 4.5 of the Code are carried, a davit span shall be provided, fitted with not less than two lifelines of sufficient length to reach the water with the ship in its lightest seagoing condition, under unfavourable conditions of trim of up to 10° and list of up to 20° either way.

Regulation 17

Rescue boat embarkation, launching and recovery arrangements

- 1 The rescue boat embarkation and launching arrangements shall be such that the rescue boat can be boarded and launched in the shortest possible time.
- 2 If the rescue boat is one of the ship's survival craft, the embarkation arrangements and launching station shall comply with the requirements of regulations 11 and 12.
- 3 Launching arrangements shall comply with the requirements of regulation 16. However, all rescue boats shall be capable of being launched, where necessary utilizing painters, with the ship making headway at speeds up to 5 knots in calm water.
- 4 Recovery time of the rescue boat shall be not more than 5 min in moderate sea conditions when loaded with its full complement of persons and equipment. If the rescue boat is also a lifeboat, this recovery time shall be possible when loaded with its lifeboat equipment and the approved rescue boat complement of at least six persons.
- 5 Rescue boat embarkation and recovery arrangements shall allow for safe and efficient handling of a stretcher case. Foul weather recovery strops shall be provided for safety if heavy fall blocks constitute a danger.

Regulation 17-1*Recovery of persons from the water*

- 1 All ships shall have ship-specific plans and procedures for recovery of persons from the water, taking into account the guidelines developed by the Organization.* The plans and procedures shall identify the equipment intended to be used for recovery purposes and measures to be taken to minimize the risk to shipboard personnel involved in recovery operations. Ships constructed before 1 July 2014 shall comply with this requirement by the first periodical or renewal safety equipment survey of the ship to be carried out after 1 July 2014, whichever comes first.
- 2 Ro-ro passenger ships which comply with regulation 26.4 shall be deemed to comply with this regulation.

Regulation 18*Line-throwing appliances*

A line-throwing appliance complying with the requirements of section 7.1 of the Code shall be provided.

Regulation 19*Emergency training and drills*

- 1 This regulation applies to all ships.
- 2 **Familiarity with safety installations and practice musters**
 - 2.1 Every crew member with assigned emergency duties shall be familiar with these duties before the voyage begins.
 - 2.2 On a ship engaged on a voyage where passengers are scheduled to be on board for more than 24 h, musters of newly-embarked passengers shall take place prior to or immediately upon departure. Passengers shall be instructed in the use of the lifejackets and the action to take in an emergency.
 - 2.3 Whenever new passengers embark, a passenger safety briefing shall be given immediately before departure, or immediately after departure. The briefing shall include the instructions required by regulations 8.2 and 8.4, and shall be made by means of an announcement, in one or more languages likely to be understood by the passengers. The announcement shall be made on the ship's public address system, or by other equivalent means likely to be heard at least by the passengers who have not yet heard it during the voyage. The briefing may be included in the muster required by paragraph 2.2. Information cards or posters or video programmes displayed on ships video displays may be used to supplement the briefing, but may not be used to replace the announcement.
- 3 **Drills**
 - 3.1 Drills shall, as far as practicable, be conducted as if there were an actual emergency.
 - 3.2 Every crew member shall participate in at least one abandon ship drill and one fire drill every month. The drills of the crew shall take place within 24 h of the ship leaving a port if more than 25% of the crew have not participated in abandon ship and fire drills on board that particular ship in the previous month. When a ship enters service for the first time, after modification of a major character or when a new crew is engaged, these drills shall be held before sailing. The Administration may accept other arrangements that are at least equivalent for those classes of ships for which this is impracticable.

* Refer to *Guidelines for the development of plans and procedures for recovery of persons from the water* (MSC.1/Circ.1447).

3.3 Crew members with enclosed space entry or rescue responsibilities shall participate in an enclosed space entry and rescue drill to be held on board the ship at least once every two months.

3.4 Abandon ship drill

3.4.1 Each abandon ship drill shall include:

- .1 summoning of passengers and crew to muster stations with the alarm required by regulation 6.4.2 followed by drill announcement on the public address or other communication system and ensuring that they are made aware of the order to abandon ship;
- .2 reporting to stations and preparing for the duties described in the muster list;
- .3 checking that passengers and crew are suitably dressed;
- .4 checking that lifejackets are correctly donned;
- .5 lowering of at least one lifeboat after any necessary preparation for launching;
- .6 starting and operating the lifeboat engine;
- .7 operation of davits used for launching liferafts;
- .8 a mock search and rescue of passengers trapped in their staterooms; and
- .9 instruction in the use of radio life-saving appliances.

3.4.2 Different lifeboats shall, as far as practicable, be lowered in compliance with the requirements of paragraph 3.4.1.5 at successive drills.

3.4.3 Except as provided in paragraphs 3.4.4 and 3.4.5, each lifeboat shall be launched, and manoeuvred in the water by its assigned operating crew, at least once every three months during an abandon ship drill.

3.4.4 In the case of a lifeboat arranged for free-fall launching, at least once every three months during an abandon ship drill the crew shall board the lifeboat, properly secure themselves in their seats and commence launch procedures up to, but not including, the actual release of the lifeboat (i.e. the release hook shall not be released). The lifeboat shall then either be free-fall launched with only the required operating crew on board, or lowered into the water by means of the secondary means of launching with or without the operating crew on board. In both cases, the lifeboat shall thereafter be manoeuvred in the water by the operating crew. At intervals of not more than six months, the lifeboat shall either be launched by free fall with only the operating crew on board, or simulated launching shall be carried out in accordance with the guidelines developed by the Organization.*

3.4.5 The Administration may allow ships operating on short international voyages not to launch the lifeboats on one side if their berthing arrangements in port and their trading patterns do not permit launching of lifeboats on that side. However, all such lifeboats shall be lowered at least once every three months and launched at least annually.

3.4.6 As far as is reasonable and practicable, rescue boats other than lifeboats which are also rescue boats, shall be launched each month with their assigned crew aboard and manoeuvred in the water. In all cases this requirement shall be complied with at least once every three months.

3.4.7 If lifeboat and rescue boat launching drills are carried out with the ship making headway, such drills shall, because of the dangers involved, be practised in sheltered waters only and under the supervision of an officer experienced in such drills.

3.4.8 If a ship is fitted with marine evacuation systems, drills shall include exercising of the procedures required for the deployment of such a system up to the point immediately preceding actual deployment of the system. This aspect of drills should be augmented by regular instruction using the on-board training aids required by regulation 35.4. Additionally every system party member shall, as far as practicable, be further

* Refer to *Measures to prevent accidents with lifeboats* (MSC.1/Circ.1206/Rev.1).

trained by participation in a full deployment of a similar system into water, either on board a ship or ashore, at intervals of not longer than two years, but in no case longer than three years. This training can be associated with the deployments required by regulation 20.8.2.

3.4.9 Emergency lighting for mustering and abandonment shall be tested at each abandon ship drill.

3.5 Fire drills

3.5.1 Fire drills should be planned in such a way that due consideration is given to regular practice in the various emergencies that may occur depending on the type of ships and the cargo.

3.5.2 Each fire drill shall include:

- .1 reporting to stations and preparing for the duties described in the muster list required by regulation 8;
- .2 starting of a fire pump, using at least the two required jets of water to show that the system is in proper working order;
- .3 checking of fireman's outfit and other personal rescue equipment;
- .4 checking of relevant communication equipment;
- .5 checking the operation of watertight doors, fire doors, fire dampers and main inlets and outlets of ventilation systems in the drill area; and
- .6 checking the necessary arrangements for subsequent abandoning of the ship.

3.5.3 The equipment used during drills shall immediately be brought back to its fully operational condition and any faults and defects discovered during the drills shall be remedied as soon as possible.

3.6 Enclosed space entry and rescue drills

3.6.1 Enclosed space entry and rescue drills should be planned and conducted in a safe manner, taking into account, as appropriate, the guidance provided in the recommendations developed by the Organization.*

3.6.2 Each enclosed space entry and rescue drill shall include:

- .1 checking and use of personal protective equipment required for entry;
- .2 checking and use of communication equipment and procedures;
- .3 checking and use of instruments for measuring the atmosphere in enclosed spaces;
- .4 checking and use of rescue equipment and procedures; and
- .5 instructions in first aid and resuscitation techniques.

4 On-board training and instructions

4.1 On-board training in the use of the ship's life-saving appliances, including survival craft equipment, and in the use of the ship's fire-extinguishing appliances shall be given as soon as possible but not later than two weeks after a crew member joins the ship. However, if the crew member is on a regularly scheduled rotating assignment to the ship, such training shall be given not later than two weeks after the time of first joining the ship. Instructions in the use of the ship's fire-extinguishing appliances, life-saving appliances, and in survival at sea shall be given at the same interval as the drills. Individual instruction may cover different parts of the ship's life-saving and fire-extinguishing appliances, but all the ship's life-saving and fire-extinguishing appliances shall be covered within any period of two months.

4.2 Every crew member shall be given instructions which shall include but not necessarily be limited to:

- .1 operation and use of the ship's inflatable liferafts;

* Refer to *Revised recommendations for entering enclosed spaces aboard ships* (resolution A.1050(27)).

- .2 problems of hypothermia, first-aid treatment for hypothermia and other appropriate first-aid procedures;
- .3 special instructions necessary for use of the ship's life-saving appliances in severe weather and severe sea conditions;
- .4 operation and use of fire-extinguishing appliances; and
- .5 risks associated with enclosed spaces and on-board procedures for safe entry into such spaces which should take into account, as appropriate, the guidance provided in recommendations developed by the Organization.*

4.3 On-board training in the use of davit-launched liferafts shall take place at intervals of not more than four months on every ship fitted with such appliances. Whenever practicable this shall include the inflation and lowering of a liferaft. This liferaft may be a special liferaft intended for training purposes only, which is not part of the ship's life-saving equipment; such a special liferaft shall be conspicuously marked.

5 Records

The date when musters are held, details of abandon ship drills and fire drills, enclosed space entry and rescue drills, drills of other life-saving appliances and on-board training shall be recorded in such logbook as may be prescribed by the Administration. If a full muster, drill or training session is not held at the appointed time, an entry shall be made in the logbook stating the circumstances and the extent of the muster, drill or training session held.

Regulation 20

Operational readiness, maintenance and inspections

1 This regulation applies to all ships. The requirements of paragraphs 3.2, 3.3 and 6.2 shall be complied with, as far as is practicable, on ships constructed before 1 July 1986.

2 Operational readiness

Before the ship leaves port and at all times during the voyage, all life-saving appliances shall be in working order and ready for immediate use.

3 Maintenance

3.1 Maintenance, testing and inspections of life-saving appliances shall be carried out in a manner having due regard to ensuring reliability of such appliances.

3.2 Instructions for on-board maintenance of life-saving appliances complying with regulation 36 shall be provided and maintenance shall be carried out accordingly.

3.3 The Administration may accept, in compliance with the requirements of paragraph 3.2, a shipboard planned maintenance programme, which includes the requirements of regulation 36.

4 Maintenance of falls

Falls used in launching shall be inspected periodically[†] with special regard for areas passing through sheaves, and renewed when necessary due to deterioration of the falls or at intervals of not more than five years, whichever is the earlier.

* Refer to the *Revised recommendations for entering enclosed spaces aboard ships* (resolution A.1050(27)).

† Refer to *Measures to prevent accidents with lifeboats* (MSC.1/Circ.1206/Rev.1).

5 Spares and repair equipment

Spares and repair equipment shall be provided for life-saving appliances and their components which are subject to excessive wear or consumption and need to be replaced regularly.

6 Weekly inspection

The following tests and inspections shall be carried out weekly and a report of the inspection shall be entered in the logbook:

- .1 all survival craft, rescue boats and launching appliances shall be visually inspected to ensure that they are ready for use. The inspection shall include, but is not limited to, the condition of hooks, their attachment to the lifeboat and the on-load release gear being properly and completely reset;
- .2 all engines in lifeboats and rescue boats shall be run for a total period of not less than 3 min, provided the ambient temperature is above the minimum temperature required for starting and running the engine. During this period of time, it should be demonstrated that the gearbox and geartrain are engaging satisfactorily. If the special characteristics of an outboard motor fitted to a rescue boat would not allow it to be run other than with its propeller submerged for a period of 3 min, a suitable water supply may be provided. In special cases, the Administration may waive this requirement for ships constructed before 1 July 1986;
- .3 lifeboats, except free-fall lifeboats, on cargo ships shall be moved from their stowed position, without any persons on board, to the extent necessary to demonstrate satisfactory operation of launching appliances, if weather and sea conditions so allow; and
- .4 the general emergency alarm shall be tested.

7 Monthly inspections

7.1 All lifeboats, except free-fall lifeboats, shall be turned out from their stowed position, without any persons on board if weather and sea conditions so allow.

7.2 Inspection of the life-saving appliances, including lifeboat equipment, shall be carried out monthly using the checklist required by regulation 36.1 to ensure that they are complete and in good order. A report of the inspection shall be entered in the log-book.

8 Servicing of inflatable liferafts, inflatable lifejackets, marine evacuation systems, and maintenance and repair of inflated rescue boats

8.1 Every inflatable liferaft, inflatable lifejacket, and marine evacuation system shall be serviced:

- .1 at intervals not exceeding 12 months, provided where in any case this is impracticable, the Administration may extend this period to 17 months; and
- .2 at an approved servicing station which is competent to service them, maintains proper servicing facilities and uses only properly trained personnel.*

8.2 Rotational deployment of marine evacuation systems

In addition to or in conjunction with the servicing intervals of marine evacuation systems required by paragraph 8.1, each marine evacuation system should be deployed from the ship on a rotational basis at intervals to be agreed by the Administration provided that each system is to be deployed at least once every six years.

8.3 An Administration which approves new and novel inflatable liferaft arrangements pursuant to regulation 4 may allow for extended service intervals on the following conditions:

* Refer to *Recommendation on conditions for the approval of servicing stations for inflatable liferafts* (resolution A.761(18), as amended).

8.3.1 The new and novel liferaft arrangement has proved to maintain the same standard, as required by testing procedure, during extended service intervals.

8.3.2 The liferaft system shall be checked on board by certified personnel according to paragraph 8.1.1.

8.3.3 Service at intervals not exceeding five years shall be carried out in accordance with the recommendations of the Organization.*

8.4 All repairs and maintenance of inflated rescue boats shall be carried out in accordance with the manufacturer's instructions. Emergency repairs may be carried out on board the ship; however, permanent repairs shall be effected at an approved servicing station.

8.5 An Administration which permits extension of liferaft service intervals in accordance with paragraph 8.3 shall notify the Organization of such action in accordance with regulation I/5(b).

9 Periodic servicing of hydrostatic release units

Hydrostatic release units, other than disposable hydrostatic release units, shall be serviced:

- .1 at intervals not exceeding 12 months, provided where in any case this is impracticable, the Administration may extend this period to 17 months;† and
- .2 at a servicing station which is competent to service them, maintains proper servicing facilities and uses only properly trained personnel.

10 Marking of stowage locations

Containers, brackets, racks, and other similar stowage locations for life-saving equipment shall be marked with symbols in accordance with the recommendations of the Organization,‡ indicating the devices stowed in that location for that purpose. If more than one device is stowed in that location, the number of devices shall also be indicated.

11 Maintenance, thorough examination, operational testing, overhaul and repair of lifeboats, rescue boats and fast rescue boats, launching appliances and release gear

SEE INTERPRETATION 5

11.1 Launching appliances shall be:

- .1 subject to a thorough examination at the annual surveys required by regulations I/7 or I/8, as applicable; and
- .2 upon completion of the examination referred to in paragraph 11.1.1, subjected to a dynamic test of the winch brake at maximum lowering speed. The load to be applied shall be the mass of the survival craft or rescue boat without persons on board, except that, at intervals of at least once every five years, the test shall be carried out with a proof load equal to 1.1 times the weight of the survival craft or rescue boat and its full complement of persons and equipment.

11.2 Lifeboat and rescue boat release gear, including fast rescue boat release gear and free-fall lifeboat release systems, shall be:

- .1 subject to a thorough examination and operational test during the annual surveys required by regulations I/7 and I/8;

* Refer to *Recommendation on conditions for the approval of servicing stations for inflatable liferafts* (resolution A.761(18), as amended).

† Refer to *Servicing of life-saving appliances and radiocommunication equipment under the Harmonized System of Survey and Certification* (HSSC) (MSC/Circ.955).

‡ Refer to *Symbols related to life-saving appliances and arrangements* (resolution A.760(18), as amended).

- .2 in case of on-load release gear, operationally tested under a load of 1.1 times the total mass of the boat when loaded with its full complement of persons and equipment whenever the release gear is overhauled. Such overhauling and operational test shall be carried out at least once every five years;* and
- .3 notwithstanding paragraph 11.2.2, the operational testing of free-fall lifeboat release systems shall be performed either by free-fall launch with only the operating crew on board or by a test without launching the lifeboat carried out based on the Requirements for maintenance, thorough examination, operational testing, overhaul and repair.

11.3 Davit-launched liferaft automatic release hooks shall be:

- .1 subject to a thorough examination and operational test during the annual surveys required by regulations I/7 and I/8; and
- .2 operationally tested under a load of 1.1 times the total mass of the liferaft when loaded with its full complement of persons and equipment whenever the automatic release hook is overhauled. Such overhauling and operational test shall be carried out at least once every five years.

11.4 Lifeboats and rescue boats, including fast rescue boats, shall be subject to a thorough examination and operational test during the annual surveys required by regulations I/7 and I/8.

11.5 The thorough examination, operational testing and overhaul required by paragraphs 11.1 to 11.4 and the maintenance and repair of equipment specified in paragraphs 11.1 to 11.4 shall be carried out in accordance with the Requirements for maintenance, thorough examination, operational testing, overhaul and repair, and the instructions for onboard maintenance as required by regulation 36.

Section II

Passenger ships (additional requirements)

Regulation 21

Survival craft and rescue boats

1 Survival craft

1.1 Passenger ships engaged on international voyages which are not short international voyages shall carry:

- .1 partially or totally enclosed lifeboats complying with the requirements of section 4.5 or 4.6 of the Code on each side of such aggregate capacity as will accommodate not less than 50% of the total number of persons on board. The Administration may permit the substitution of lifeboats by liferafts of equivalent total capacity provided that there shall never be less than sufficient lifeboats on each side of the ship to accommodate 37.5% of the total number of persons on board. The inflatable or rigid liferafts shall comply with the requirements of section 4.2 or 4.3 of the Code and shall be served by launching appliances equally distributed on each side of the ship; and
- .2 in addition, inflatable or rigid liferafts complying with the requirements of section 4.2 or 4.3 of the Code of such aggregate capacity as will accommodate at least 25% of the total number of persons on board. These liferafts shall be served by at least one launching appliance on each side which may be those provided in compliance with the requirements of paragraph 1.1.1 or equivalent approved appliances capable of being used on both sides. However, stowage of these liferafts need not comply with the requirements of regulation 13.5.

* Refer to *Recommendation on testing of life-saving appliances* (resolution A.689(17), as amended). For life-saving appliances installed on board on or after 1 July 1999, refer to *Revised recommendation on testing of life-saving appliances* (resolution MSC.81(70), as amended).

1.2 Passenger ships engaged on short international voyages shall carry:

- .1** partially or totally enclosed lifeboats complying with the requirements of section 4.5 or 4.6 of the Code of such aggregate capacity as will accommodate at least 30% of the total number of persons on board. The lifeboats shall, as far as practicable, be equally distributed on each side of the ship. In addition inflatable or rigid liferafts complying with the requirements of section 4.2 or 4.3 of the Code shall be carried of such aggregate capacity that, together with the lifeboat capacity, the survival craft will accommodate the total number of persons on board. The liferafts shall be served by launching appliances equally distributed on each side of the ship; and
- .2** in addition, inflatable or rigid liferafts complying with the requirements of section 4.2 or 4.3 of the Code of such aggregate capacity as will accommodate at least 25% of the total number of persons on board. These liferafts shall be served by at least one launching appliance on each side which may be those provided in compliance with the requirements of paragraph 1.2.1 or equivalent approved appliances capable of being used on both sides. However, stowage of these liferafts need not comply with the requirements of regulation 13.5.

1.3 All survival craft required to provide for abandonment by the total number of persons on board shall be capable of being launched with their full complement of persons and equipment within a period of 30 min from the time the abandon ship signal is given after all persons have been assembled, with lifejackets donned.

1.4 In lieu of meeting the requirements of paragraph 1.1 or 1.2, passenger ships of less than 500 gross tonnage where the total number of persons on board is less than 200, may comply with the following:

- .1** they shall carry on each side of the ship, inflatable or rigid liferafts complying with the requirements of section 4.2 or 4.3 of the Code and of such aggregate capacity as will accommodate the total number of persons on board;
- .2** unless the liferafts required by paragraph 1.4.1 are stowed in a position providing for easy side-to-side transfer at a single open deck level, additional liferafts shall be provided so that the total capacity available on each side will accommodate 150% of the total number of persons on board;
- .3** if the rescue boat required by paragraph 2.2 is also a partially or totally enclosed lifeboat complying with the requirements of section 4.5 or 4.6 of the Code, it may be included in the aggregate capacity required by paragraph 1.4.1, provided that the total capacity available on either side of the ship is at least 150% of the total number of persons on board; and
- .4** in the event of any one survival craft being lost or rendered unserviceable, there shall be sufficient survival craft available for use on each side, including those which are stowed in a position providing for easy side-to-side transfer at a single open deck level, to accommodate the total number of persons on board.

1.5 A marine evacuation system or systems complying with section 6.2 of the Code may be substituted for the equivalent capacity of liferafts and launching appliances required by paragraph 1.1.1 or 1.2.1.

2 Rescue boats

2.1 Passenger ships of 500 gross tonnage and over shall carry at least one rescue boat complying with the requirements of section 5.1 of the Code on each side of the ship.

2.2 Passenger ships of less than 500 gross tonnage shall carry at least one rescue boat complying with the requirements of section 5.1 of the Code.

2.3 A lifeboat may be accepted as a rescue boat provided that it and its launching and recovery arrangements also comply with the requirements for a rescue boat.

3 Marshalling of liferafts

3.1 The number of lifeboats and rescue boats that are carried on passenger ships shall be sufficient to ensure that in providing for abandonment by the total number of persons on board not more than six liferafts need be marshalled by each lifeboat or rescue boat.

3.2 The number of lifeboats and rescue boats that are carried on passenger ships engaged on short international voyages shall be sufficient to ensure that in providing for abandonment by the total number of persons on board not more than nine liferafts need be marshalled by each lifeboat or rescue boat.

Regulation 22

Personal life-saving appliances

1 Lifebuoys

1.1 A passenger ship shall carry not less than the number of lifebuoys complying with the requirements of regulation 7.1 and section 2.1 of the Code prescribed in the following table:

SEE INTERPRETATION 6

Length of ship in metres	Minimum number of lifebuoys
Under 60	8
60 and under 120	12
120 and under 180	18
180 and under 240	24
240 and over	30

1.2 Notwithstanding regulation 7.1.3, passenger ships of under 60 m in length shall carry not less than six lifebuoys provided with self-igniting lights.

2 Lifejackets

2.1 In addition to the lifejackets required by regulation 7.2, every passenger ship shall carry lifejackets for not less than 5% of the total number of persons on board. These lifejackets shall be stowed in conspicuous places on deck or at muster stations.

2.2 Where lifejackets for passengers are stowed in staterooms which are located remotely from direct routes between public spaces and muster stations, the additional lifejackets for these passengers required under regulation 7.2.2, shall be stowed either in the public spaces, the muster stations, or on direct routes between them. The lifejackets shall be stowed so that their distribution and donning does not impede orderly movement to muster stations and survival craft embarkation stations.

3 Lifejacket lights

3.1 On all passenger ships each lifejacket shall be fitted with a light complying with the requirements of paragraph 2.2.3 of the Code.

3.2 Lights fitted on lifejackets on board passenger ships prior to 1 July 1998 and not complying fully with paragraph 2.2.3 of the Code may be accepted by the Administration until the lifejacket light would normally be replaced or until the first periodical survey after 1 July 2002, whichever is the earliest.

4 Immersion suits and thermal protective aids

4.1 All passenger ships shall carry for each lifeboat on the ship at least three immersion suits complying with the requirements of section 2.3 of the Code and, in addition, a thermal protective aid complying with the requirements of section 2.5 of the Code for every person to be accommodated in the lifeboat and not provided with an immersion suit. These immersion suits and thermal protective aids need not be carried:

- .1 for persons to be accommodated in totally or partially enclosed lifeboats; or

- .2 if the ship is constantly engaged on voyages in warm climates* where, in the opinion of the Administration, they are unnecessary.

4.2 The provisions of paragraph 4.1.1 also apply to partially or totally enclosed lifeboats not complying with the requirements of section 4.5 or 4.6 of the Code, provided they are carried on ships constructed before 1 July 1986.

Regulation 23

Survival craft and rescue boat, embarkation arrangements

1 On passenger ships, survival craft embarkation arrangements shall be designed for:

- .1 all lifeboats to be boarded and launched either directly from the stowed position or from an embarkation deck but not both; and
- .2 davit-launched liferafts to be boarded and launched from a position immediately adjacent to the stowed position or from a position to which, in compliance with the requirements of regulation 13.5, the liferaft is transferred prior to launching.

2 Rescue boat arrangements shall be such that the rescue boat can be boarded and launched directly from the stowed position with the number of persons assigned to crew the rescue boat on board. Notwithstanding the requirements of paragraph 1.1, if the rescue boat is also a lifeboat and the other lifeboats are boarded and launched from an embarkation deck, the arrangements shall be such that the rescue boat can also be boarded and launched from the embarkation deck.

Regulation 24

Stowage of survival craft

The stowage height of a survival craft on a passenger ship shall take into account the requirements of regulation 13.1.2, the escape provisions of regulation II-2/13, the size of the ship, and the weather conditions likely to be encountered in its intended area of operation. For a davit-launched survival craft, the height of the davit head with the survival craft in embarkation position, shall, as far as practicable, not exceed 15 m to the waterline when the ship is in its lightest seagoing condition.

Regulation 25

Muster stations

Every passenger ship shall, in addition to complying with the requirements of regulation 11, have passenger muster stations which shall:

- .1 be in the vicinity of, and permit ready access for the passengers to, the embarkation stations unless in the same location; and
- .2 have ample room for marshalling and instruction of the passengers, but at least 0.35 m² per passenger.

Regulation 26

Additional requirements for ro-ro passenger ships

1 This regulation applies to all ro-ro passenger ships. Ro-ro passenger ships constructed:

- .1 on or after 1 July 1998 shall comply with the requirements of paragraphs 2.3, 2.4, 3.1, 3.2, 3.3, 4 and 5;

* Refer to *Guidelines for the assessment of thermal protection* (MSC/Circ.1046).

- .2 on or after 1 July 1986 and before 1 July 1998 shall comply with the requirements of paragraph 5 not later than the first periodical survey after 1 July 1998 and with the requirements of paragraphs 2.3, 2.4, 3 and 4 not later than the first periodical survey after 1 July 2000;
- .3 before 1 July 1986 shall comply with the requirements of paragraph 5 not later than the first periodical survey after 1 July 1998 and with the requirements of paragraphs 2.1, 2.2, 2.3, 2.4, 3 and 4 not later than the first periodical survey after 1 July 2000; and
- .4 before 1 July 2004 shall comply with the requirements of paragraph 2.5 not later than the first survey on or after that date.

2 Liferafts

2.1 The ro-ro passenger ship's liferafts shall be served by marine evacuation systems complying with the requirements of section 6.2 of the Code or launching appliances complying with the requirements of paragraph 6.1.5 of the Code, equally distributed on each side of the ship.

2.2 Every liferaft on ro-ro passenger ships shall be provided with float-free stowage arrangements complying with the requirements of regulation 13.4.

2.3 Every liferaft on ro-ro passenger ships shall be of a type fitted with a boarding ramp complying with the requirements of paragraph 4.2.4.1 or 4.3.4.1 of the Code, as appropriate.

2.4 Every liferaft on ro-ro passenger ships shall either be automatically self-righting or be a canopied reversible liferaft which is stable in a seaway and is capable of operating safely whichever way up it is floating. Alternatively, the ship shall carry automatically self-righting liferafts or canopied reversible liferafts, in addition to its normal complement of liferafts, of such aggregate capacity as will accommodate at least 50% of the persons not accommodated in lifeboats. This additional liferaft capacity shall be determined on the basis of the difference between the total number of persons on board and the number of persons accommodated in lifeboats. Every such liferaft shall be approved by the Administration having regard to the recommendations adopted by the Organization.*

2.5 Liferafts carried on ro-ro passenger ships shall be fitted with a search and rescue locating device in the ratio of one search and rescue locating device for every four liferafts. The search and rescue locating device shall be mounted inside the liferaft so its antenna is more than 1 m above the sea level when the liferaft is deployed, except that for canopied reversible liferafts the search and rescue locating device shall be so arranged as to be readily accessed and erected by survivors. Each search and rescue locating device shall be arranged to be manually erected when the liferaft is deployed. Containers of liferafts fitted with search and rescue locating devices shall be clearly marked.

3 Fast rescue boats

3.1 At least one of the rescue boats on a ro-ro passenger ship shall be a fast rescue boat complying with section 5.1.4 of the Code.*

3.2 Each fast rescue boat shall be served by a suitable launching appliance complying with section 6.1.7 of the Code.*

3.3 At least two crews of each fast rescue boat shall be trained and drilled regularly having regard to the Seafarers' Training, Certification and Watchkeeping (STCW) Code and recommendations adopted by the Organization,† including all aspects of rescue, handling, manoeuvring, operating these craft in various conditions, and righting them after capsize.

* Refer to *Recommendation for canopied reversible liferafts, automatically self-righting liferafts and fast rescue boats, including testing, on ro-ro passenger ships* (MSC/Circ.809).

† Refer to *Recommendation on training requirements for crews of fast rescue boats* (resolution A.771(18)) and to section A-VI/2, table A-VI/2-2, Specification of the minimum standard of competence in fast rescue boats, of the STCW Code.

3.4 In the case where the arrangement or size of a ro-ro passenger ship, constructed before 1 July 1997, is such as to prevent the installation of the fast rescue boat required by paragraph 3.1, the fast rescue boat may be installed in place of an existing lifeboat which is accepted as a rescue boat or, in the case of ships constructed prior to 1 July 1986, boats for use in an emergency, provided that all of the following conditions are met:

- .1 the fast rescue boat installed is served by a launching appliance complying with the provisions of paragraph 3.2;
- .2 the capacity of the survival craft lost by the above substitution is compensated by the installation of liferafts capable of carrying at least an equal number of persons served by the lifeboat replaced; and
- .3 such liferafts are served by the existing launching appliances or marine evacuation systems.

4 Means of rescue*

4.1 Each ro-ro passenger ship shall be equipped with efficient means for rapidly recovering survivors from the water and transferring survivors from rescue units or survival craft to the ship.

4.2 The means of transfer of survivors to the ship may be part of a marine evacuation system, or may be part of a system designed for rescue purposes.

4.3 If the slide of a marine evacuation system is intended to provide the means of transfer of survivors to the deck of the ship, the slide shall be equipped with handlines or ladders to aid in climbing up the slide.

5 Lifejackets

5.1 Notwithstanding the requirements of regulations 7.2 and 22.2, a sufficient number of lifejackets shall be stowed in the vicinity of the muster stations so that passengers do not have to return to their cabins to collect their lifejackets.

5.2 In ro-ro passenger ships, each lifejacket shall be fitted with a light complying with the requirements of paragraph 2.2.3 of the Code.

Regulation 27

Information on passengers

1 All persons on board all passenger ships shall be counted prior to departure.

2 Details of persons who have declared a need for special care or assistance in emergency situations shall be recorded and communicated to the master prior to departure.

3 In addition, not later than 1 January 1999, the names and gender of all persons on board, distinguishing between adults, children and infants shall be recorded for search and rescue purposes.

4 The information required by paragraphs 1, 2 and 3 shall be kept ashore and made readily available to search and rescue services when needed.

5 Administrations may exempt passenger ships from the requirements of paragraph 3, if the scheduled voyages of such ships render it impracticable for them to prepare such records.

* Refer to *Recommendation on means of rescue on ro-ro passenger ships* (MSC/Circ.810).

Regulation 28*Helicopter landing and pick-up areas*

- 1 All ro-ro passenger ships shall be provided with a helicopter pick-up area approved by the Administration having regard to the recommendations adopted by the Organization.*
- 2 Ro-ro† passenger ships of 130 m in length and upwards, constructed on or after 1 July 1999, shall be fitted with a helicopter landing area approved by the Administration having regard to the recommendations adopted by the Organization.‡

Regulation 29*Decision support system for masters of passenger ships*

- 1 This regulation applies to all passenger ships. Passenger ships constructed before 1 July 1997 shall comply with the requirements of this regulation not later than the date of the first periodical survey after 1 July 1999.
- 2 In all passenger ships, a decision support system for emergency management shall be provided on the navigation bridge.
- 3 The system shall, as a minimum, consist of a printed emergency plan or plans.§ All foreseeable emergency situations shall be identified in the emergency plan or plans, including, but not limited to, the following main groups of emergencies:
 - .1 fire;
 - .2 damage to ship;
 - .3 pollution;
 - .4 unlawful acts threatening the safety of the ship and the security of its passengers and crew;
 - .5 personnel accidents;
 - .6 cargo-related accidents; and
 - .7 emergency assistance to other ships.
- 4 The emergency procedures established in the emergency plan or plans shall provide decision support to masters for handling any combination of emergency situations.
- 5 The emergency plan or plans shall have a uniform structure and be easy to use. Where applicable, the actual loading condition as calculated for the passenger ship's voyage stability shall be used for damage control purposes.
- 6 In addition to the printed emergency plan or plans, the Administration may also accept the use of a computer-based decision support system on the navigation bridge which provides all the information contained in the emergency plan or plans, procedures, checklists, etc., which is able to present a list of recommended actions to be carried out in foreseeable emergencies.

* Refer to the *International Aeronautical and Maritime Search and Rescue Manual* (IAMSAR Manual).

† Refer to *Application of SOLAS regulation III/28.2 concerning helicopter landing areas on non-ro-ro passenger ships* (MSC/Circ.907).

‡ Refer to *Recommendation on helicopter landing areas on ro-ro passenger ships* (MSC/Circ.895, as amended by MSC.1/Circ.1524) and *Guidelines for approval of helicopter foam fire-fighting appliances* (MSC.1/Circ.1431).

§ Refer to *Revised guidelines for a structure of an integrated system of contingency planning for shipboard emergencies* (resolution A.1072(28) and Corr.1).

Regulation 30

Drills

- 1 This regulation applies to all passenger ships.
- 2 On passenger ships, an abandon ship drill and fire drill shall take place weekly. The entire crew need not be involved in every drill, but each crew member must participate in an abandon ship drill and a fire drill each month as required in regulation 19.3.2. Passengers shall be strongly encouraged to attend these drills.
- 3 Damage control drills shall be conducted as required in regulation II-1/19-1.

Section III

Cargo ships (additional requirements)

Regulation 31

Survival craft and rescue boats

1 Survival craft

1.1 Cargo ships shall carry:

- .1 one or more totally enclosed lifeboats complying with the requirements of section 4.6 of the Code of such aggregate capacity on each side of the ship as will accommodate the total number of persons on board; and
- .2 in addition, one or more inflatable or rigid liferafts, complying with the requirements of section 4.2 or 4.3 of the Code, of a mass of less than 185 kg and stowed in a position providing for easy side-to-side transfer at a single open deck level, and of such aggregate capacity as will accommodate the total number of persons on board. If the liferaft or liferafts are not of a mass of less than 185 kg and stowed in a position providing for easy side-to-side transfer at a single open deck level, the total capacity available on each side shall be sufficient to accommodate the total number of persons on board.

1.2 In lieu of meeting the requirements of paragraph 1.1, cargo ships may carry:

- .1 one or more free-fall lifeboats, complying with the requirements of section 4.7 of the Code, capable of being free-fall launched over the stern of the ship of such aggregate capacity as will accommodate the total number of persons on board; and
- .2 in addition, one or more inflatable or rigid liferafts complying with the requirements of section 4.2 or 4.3 of the Code, on each side of the ship, of such aggregate capacity as will accommodate the total number of persons on board. The liferafts on at least one side of the ship shall be served by launching appliances.

1.3 In lieu of meeting the requirements of paragraph 1.1 or 1.2, cargo ships of less than 85 m in length other than oil tankers, chemical tankers and gas carriers, may comply with the following:

- .1 they shall carry on each side of the ship, one or more inflatable or rigid liferafts complying with the requirements of section 4.2 or 4.3 of the Code and of such aggregate capacity as will accommodate the total number of persons on board;
- .2 unless the liferafts required by paragraph 1.3.1 are of a mass of less than 185 kg and stowed in a position providing for easy side-to-side transfer at a single open deck level, additional liferafts shall be provided so that the total capacity available on each side will accommodate 150% of the total number of persons on board;

- .3 if the rescue boat required by paragraph 2 is also a totally enclosed lifeboat complying with the requirements of section 4.6 of the Code, it may be included in the aggregate capacity required by paragraph 1.3.1, provided that the total capacity available on either side of the ship is at least 150% of the total number of persons on board; and
- .4 in the event of any one survival craft being lost or rendered unserviceable, there shall be sufficient survival craft available for use on each side, including any which are of a mass of less than 185 kg and stowed in a position providing for easy side-to-side transfer at a single open deck level, to accommodate the total number of persons on board.

1.4 Cargo ships where the horizontal distance from the extreme end of the stem or stern of the ship to the nearest end of the closest survival craft is more than 100 m shall carry, in addition to the liferafts required by paragraphs 1.1.2 and 1.2.2, a liferaft stowed as far forward or aft, or one as far forward and another as far aft, as is reasonable and practicable. Such liferaft or liferafts may be securely fastened so as to permit manual release and need not be of the type which can be launched from an approved launching device.

SEE INTERPRETATION 7

1.5 With the exception of the survival craft referred to in regulation 16.1.1, all survival craft required to provide for abandonment by the total number of persons on board shall be capable of being launched with their full complement of persons and equipment within a period of 10 min from the time the abandon ship signal is given.

1.6 Chemical tankers and gas carriers carrying cargoes emitting toxic vapours or gases* shall carry, in lieu of totally enclosed lifeboats complying with the requirements of section 4.6 of the Code, lifeboats with a self-contained air support system complying with the requirements of section 4.8 of the Code.

1.7 Oil tankers, chemical tankers and gas carriers carrying cargoes having a flashpoint not exceeding 60°C (closed-cup test) shall carry, in lieu of totally enclosed lifeboats complying with the requirements of section 4.6 of the Code, fire-protected lifeboats complying with the requirements of section 4.9 of the Code.

1.8 Notwithstanding the requirements of paragraph 1.1, bulk carriers as defined in regulation IX/1.6 constructed on or after 1 July 2006 shall comply with the requirements of paragraph 1.2.

SEE INTERPRETATION 8

2 Rescue boats

Cargo ships shall carry at least one rescue boat complying with the requirements of section 5.1 of the Code. A lifeboat may be accepted as a rescue boat, provided that it and its launching and recovery arrangements also comply with the requirements for a rescue boat.

- 3 In addition to their lifeboats, all cargo ships constructed before 1 July 1986 shall carry:
 - .1 one or more liferafts capable of being launched on either side of the ship and of such aggregate capacity as will accommodate the total number of persons on board. The liferaft or liferafts shall be equipped with a lashing or an equivalent means of securing the liferaft which will automatically release it from a sinking ship; and
 - .2 where the horizontal distance from the extreme end of the stem or stern of the ship to the nearest end of the closest survival craft is more than 100 m, in addition to the liferafts required by paragraph 3.1, a liferaft stowed as far forward or aft, or one as far forward and another as far aft, as is reasonable and practicable. Notwithstanding the requirements of paragraph 3.1, such liferaft or liferafts may be securely fastened so as to permit manual release.

* Refer to the products for which emergency escape respiratory protection is required in chapter 17 of the IBC Code (resolution MSC.4(48), as amended), and in chapter 19 of the IGC Code (resolution MSC.5(48), as amended).

Regulation 32*Personal life-saving appliances***1 Lifebuoys**

1.1 Cargo ships shall carry not less than the number of lifebuoys complying with the requirements of regulation 7.1 and section 2.1 of the Code prescribed in the following table:

SEE INTERPRETATION 6

Length of ship in metres	Minimum number of lifebuoys
Under 100	8
100 and under 150	10
150 and under 200	12
200 and over	14

1.2 Self-igniting lights for lifebuoys on tankers required by regulation 7.1.3 shall be of an electric battery type.

2 Lifejacket lights

2.1 This paragraph applies to all cargo ships.

2.2 On cargo ships, each lifejacket shall be fitted with a lifejacket light complying with the requirements of paragraph 2.2.3 of the Code.

2.3 Lights fitted on lifejackets on board cargo ships prior to 1 July 1998 and not complying fully with paragraph 2.2.3 of the Code may be accepted by the Administration until the lifejacket light would normally be replaced or until the first periodical survey after 1 July 2001, whichever is the earliest.

3 Immersion suits

3.1 This paragraph applies to all cargo ships. However, with respect to cargo ships constructed before 1 July 2006, paragraphs 3.2 to 3.5 shall be complied with not later than the first safety equipment survey on or after 1 July 2006.

3.2 An immersion suit of an appropriate size complying with the requirements of section 2.3 of the Code shall be provided for every person on board the ship. However, for ships other than bulk carriers, as defined in regulation IX/1, these immersion suits need not be required if the ship is constantly engaged on voyages in warm climates* where, in the opinion of the Administration, immersion suits are unnecessary.

3.3 If a ship has any watch or work stations which are located remotely from the place or places where immersion suits are normally stowed, including remotely located survival craft carried in accordance with regulation 31.1.4, additional immersion suits of an appropriate size shall be provided at these locations for the number of persons normally on watch or working at those locations at any time.

3.4 Immersion suits shall be so placed as to be readily accessible and their position shall be plainly indicated.

3.5 The immersion suits required by this regulation may be used to comply with the requirements of regulation 7.3.

* Refer to *Guidelines for the assessment of thermal protection* (MSC/Circ.1046).

Regulation 33*Survival craft embarkation and launching arrangements*

1 Cargo ship survival craft embarkation arrangements shall be so designed that lifeboats can be boarded and launched directly from the stowed position and davit-launched liferafts can be boarded and launched from a position immediately adjacent to the stowed position or from a position to which the liferaft is transferred prior to launching in compliance with the requirements of regulation 13.5.

2 On cargo ships of 20,000 gross tonnage and upwards, lifeboats shall be capable of being launched, where necessary utilizing painters, with the ship making headway at speeds up to 5 knots in calm water.

Section IV

Life-saving appliances and arrangements requirements

Regulation 34

All life-saving appliances and arrangements shall comply with the applicable requirements of the Code.

Section V

Miscellaneous

Regulation 35*Training manual and on-board training aids*

1 This regulation applies to all ships.

2 A training manual complying with the requirements of paragraph 3 shall be provided in each crew mess room and recreation room or in each crew cabin.

3 The training manual, which may comprise several volumes, shall contain instructions and information, in easily understood terms illustrated wherever possible, on the life-saving appliances provided in the ship and on the best methods of survival. Any part of such information may be provided in the form of audio-visual aids in lieu of the manual. The following shall be explained in detail:

- .1 donning of lifejackets, immersion suits and anti-exposure suits, as appropriate;
- .2 muster at the assigned stations;
- .3 boarding, launching and clearing the survival craft and rescue boats, including, where applicable, use of marine evacuation systems;
- .4 method of launching from within the survival craft;
- .5 release from launching appliances;
- .6 methods and use of devices for protection in launching areas, where appropriate;
- .7 illumination in launching areas;
- .8 use of all survival equipment;
- .9 use of all detection equipment;
- .10 with the assistance of illustrations, the use of radio life-saving appliances;
- .11 use of drogues;
- .12 use of engine and accessories;

- .13 recovery of survival craft and rescue boats including stowage and securing;
 - .14 hazards of exposure and the need for warm clothing;
 - .15 best use of the survival craft facilities in order to survive;
 - .16 methods of retrieval, including the use of helicopter rescue gear (slings, baskets, stretchers), breeches buoy and shore life-saving apparatus and ship's line-throwing apparatus;
 - .17 all other functions contained in the muster list and emergency instructions; and
 - .18 instructions for emergency repair of the life-saving appliances.
- 4 Every ship fitted with a marine evacuation system shall be provided with on-board training aids in the use of the system.
- 5 The training manual shall be written in the working language of the ship.

Regulation 36

Instructions for on-board maintenance

Instructions for on-board maintenance of life-saving appliances shall be easily understood, illustrated wherever possible, and, as appropriate, shall include the following for each appliance:

- .1 a checklist for use when carrying out the inspections required by regulation 20.7;
- .2 maintenance and repair instructions;
- .3 schedule of periodic maintenance;
- .4 diagram of lubrication points with the recommended lubricants;
- .5 list of replaceable parts;
- .6 list of sources of spare parts; and
- .7 log for records of inspections and maintenance.

Regulation 37

Muster list and emergency instructions

- 1 The muster list shall specify details of the general emergency alarm and public address system prescribed by section 7.2 of the Code and also action to be taken by crew and passengers when this alarm is sounded. The muster list shall also specify how the order to abandon ship will be given.
- 2 Each passenger ship shall have procedures in place for locating and rescuing passengers trapped in their staterooms.
- 3 The muster list shall show the duties assigned to the different members of the crew including:
- .1 closing of the watertight doors, fire doors, valves, scuppers, sidescuttles, skylights, portholes and other similar openings in the ship;
 - .2 equipping of the survival craft and other life-saving appliances;
 - .3 preparation and launching of survival craft;
 - .4 general preparations of other life-saving appliances;
 - .5 muster of passengers;
 - .6 use of communication equipment;
 - .7 manning of fire parties assigned to deal with fires;

-
- .8 special duties assigned in respect to the use of fire-fighting equipment and installations; and
 - .9 for passenger ships only, damage control for flooding emergencies.
- 4 The muster list shall specify which officers are assigned to ensure that life-saving and fire appliances are maintained in good condition and are ready for immediate use.
- 5 The muster list shall specify substitutes for key persons who may become disabled, taking into account that different emergencies may call for different actions.
- 6 The muster list shall show the duties assigned to members of the crew in relation to passengers in case of emergency. These duties shall include:
- .1 warning the passengers;
 - .2 seeing that they are suitably clad and have donned their lifejackets correctly;
 - .3 assembling passengers at muster stations;
 - .4 keeping order in the passageways and on the stairways and generally controlling the movements of the passengers; and
 - .5 ensuring that a supply of blankets is taken to the survival craft.
- 7 The muster list shall be prepared before the ship proceeds to sea. After the muster list has been prepared, if any change takes place in the crew which necessitates an alteration in the muster list, the master shall either revise the list or prepare a new list.
- 8 The format of the muster list used on passenger ships shall be approved.

Part C

Alternative design and arrangements

III

Regulation 38 *Alternative design and arrangements*

1 Purpose

The purpose of this regulation is to provide a methodology for alternative design and arrangements for life-saving appliances and arrangements.

2 General

2.1 Life-saving appliances and arrangements may deviate from the requirements set out in part B, provided that the alternative design and arrangements meet the intent of the requirements concerned and provide an equivalent level of safety to this chapter.

2.2 When alternative design or arrangements deviate from the prescriptive requirements of part B, an engineering analysis, evaluation and approval of the design and arrangements shall be carried out in accordance with this regulation.

3 Engineering analysis

The engineering analysis shall be prepared and submitted to the Administration, based on the guidelines developed by the Organization* and shall include, as a minimum, the following elements:

- .1 determination of the ship type and the life-saving appliance and arrangements concerned;
- .2 identification of the prescriptive requirement(s) with which the life-saving appliance and arrangements will not comply;
- .3 identification of the reason the proposed design will not meet the prescriptive requirements supported by compliance with other recognized engineering or industry standards;
- .4 determination of the performance criteria for the ship and the life-saving appliance and arrangements concerned addressed by the relevant prescriptive requirement(s):
 - .1 performance criteria shall provide a level of safety not inferior to the relevant prescriptive requirements contained in part B; and
 - .2 performance criteria shall be quantifiable and measurable;
- .5 detailed description of the alternative design and arrangements, including a list of the assumptions used in the design and any proposed operational restrictions or conditions;
- .6 technical justification demonstrating that the alternative design and arrangements meet the safety performance criteria; and
- .7 risk assessment based on identification of the potential faults and hazards associated with the proposal.

* Refer to *Revised guidelines on alternative design and arrangements for SOLAS chapters II-1 and III* (MSC.1/Circ.1212/Rev.1).

4 Evaluation of the alternative design and arrangements

4.1 The engineering analysis required in paragraph 3 shall be evaluated and approved by the Administration, taking into account the guidelines developed by the Organization.*

4.2 A copy of the documentation, as approved by the Administration, indicating that the alternative design and arrangements comply with this regulation, shall be carried on board the ship.

5 Exchange of information

The Administration shall communicate to the Organization pertinent information concerning alternative design and arrangements approved by them for circulation to all Contracting Governments.

6 Re-evaluation due to change of conditions

If the assumptions and operational restrictions that were stipulated in the alternative design and arrangements are changed, the engineering analysis shall be carried out under the changed condition and shall be approved by the Administration.

* Refer to *Revised guidelines on alternative design and arrangements for SOLAS chapters II-1 and III* (MSC.1/Circ.1212/Rev.1).



Unified Interpretations for Chapter III

1 Application

(Source: MSC-MEPC.2/Circ.10)

Reg. 1.4.2 For single-hull oil tanker conversion into double-hull oil tanker or bulk carrier, this should be considered as an alteration or modification of a major character.

2 First scheduled dry-docking

(Source: MSC.1/Circ.1445)

Reg. 1.5 In the context of SOLAS regulation III/1.5, the wording "first scheduled dry-docking" was introduced to mean the "first scheduled out of water survey of the ship's outer bottom". This explanation is to clarify that the on-load release mechanisms need not be compliant during an in-water survey, should this occur before a dry-docking.

3 General

(Source: MSC.1/Circ.1530)

Regs. 6.4, 6.5 3.1 The term "accommodation" defined in SOLAS regulation II-2/3.1 applies also to SOLAS regulation III/6.4.3.

3.2 The term "similar spaces" used in SOLAS regulation II-2/3.1, when applied to public address and general alarm systems required in SOLAS regulations II-2/12.3, III/6.4 and III/6.5, includes, but is not limited to, the following spaces: stairways, lifts, recreation rooms and pantries.

3.3 The word "audibility" or the term "audible" used in SOLAS regulations III/6.4.2, III/6.4.3 and III/6.5, and when referred to in these unified interpretations, means the sound pressure level requirements as defined in section 7.2 of the LSA Code.

General emergency alarm

3.4 Regarding the audibility (sound pressure) requirements in SOLAS regulations III/6.4.2 and III/6.4.3 and section 7.2 of the LSA Code, the audibility (sound pressure) requirements as defined in section 7.2 of the LSA Code should include special category spaces, ro-ro spaces and vehicle spaces as defined in SOLAS regulations II-2/3.46, II 2/3.41 and II-2/3.49 on all types of ship that carry vehicles (for example PCC/PCTC/ROPAX vessel).

3.5 For cargo ships, it is not necessary to provide a public address system in cargo spaces used for the carriage of vehicles (i.e. only a general emergency alarm is required in spaces used for the carriage of vehicles on cargo ships).

3.6 Regarding SOLAS regulation III/6.4.3, the term "normal crew working spaces" includes spaces where routine maintenance tasks or local control of machinery operated at sea are undertaken.

Public address system

3.7 Regarding the audibility (sound pressure) requirements in SOLAS regulation III/6.5.2 for passenger ships, the audibility (sound pressure) requirements should include special category spaces, ro-ro spaces and vehicle spaces as defined in SOLAS regulations II-2/3.41, II 2/3.46 and II-2/3.49 on board passenger ships, if accessible by the general public at sea.

3.8 For cargo ships, it is not necessary to provide a public address system in cargo spaces used for the carriage of vehicles (i.e. only a general emergency alarm is required in spaces used for the carriage of vehicles on cargo ships).

3.9 Regarding SOLAS regulation III/6.5.2 and the requirements of paragraph 7.2.2.1 of the LSA Code, the term "spaces where crew members or passengers or both are normally present" includes all accommodation spaces. With respect to spaces where a public address system may not be required in accordance with paragraph 7.2.2.1 of the LSA Code, these may be spaces such as under deck passageways, including passageways in the car hold between an accommodation space and an engine-room, bosun's lockers and pump-rooms.

3.10 With respect to cabin/state rooms, the sound pressure levels as stated in paragraph 7.2.2.2.1 of the LSA Code should be attained as required inside the cabin/state room, during sea trials.

3.11 Where an individual loudspeaker has a device for local silencing, an override arrangement from the control station(s), including the navigating bridge, should be in place.

4 Stowage of marine evacuation systems (Source: MSC.1/Circ.1397)

- Reg. 15.1 4.1 SOLAS regulation III/15.1 requires that the ship's side shall not have any openings between the embarkation station of the marine evacuation station and the sea level in the lightest seagoing condition. This means no openings, be they permanent openings, recessed promenades or temporary openings such as shell doors, windows or ports, should be allowed in this particular area.
- 4.2 On passenger ships, windows and side scuttles of the non-opening type should be allowed in this area if complying with SOLAS regulation II-2/9.4.1.3.3. On cargo ships, the windows and side scuttles in the area in way of a marine evacuation system, if installed, should only be of the non-opening type.

5 Maintenance, thorough examination, operational testing, overhaul and repair of lifeboats, rescue boats and fast rescue boats, launching appliances and release gear (Source: MSC.1/Circ.1618)

- Reg. 20.11 The thorough examinations, overhauls and operational tests, carried out at intervals of at least once every five years, should be done in the presence of a surveyor.

6 Personal life-saving appliances, lifebuoys (Source: MSC.1/Circ.1618)

- Regs. 22.1.1, 32.1.1 When considering the minimum number and distribution of lifebuoys as required by regulations 22.1.1 or 32.1.1, as applicable, a lifebuoy, fitted with both a light and a lifeline as per MSC.1/Circular.1331 for compliance with SOLAS regulation II-1/3-9.2, should not be taken into account.

7 Arrangements for remotely located survival craft (Source: MSC.1/Circ.1490/Rev.1)

- Reg. 31.1.4 7.1 Liferrafts required by SOLAS regulation III/31.1.4 should be regarded as "remotely located survival craft" with regard to SOLAS regulation III/7.2.1.4.
- 7.2 The area where these remotely located survival craft are stowed should be provided with:
- .1 a minimum number of two lifejackets and two immersion suits;
 - .2 adequate means of illumination complying with SOLAS regulation III/16.7, either fixed or portable, which should be capable of illuminating the liferaft stowage position, as well as the area of water into which the liferaft should be launched; portable lights, when used, should have brackets to permit their positioning on both sides of the vessel;
 - .3 an embarkation ladder or other means of embarkation enabling descent to the water in a controlled manner* as per SOLAS regulation III/11.7; and
 - .4 self-contained battery-powered lamps (i.e. luminaires) may be accepted as means of illumination for complying with SOLAS regulation III/16.7. Such lamps should be capable of being recharged from the ship's main and emergency source of electrical power, and should be stowed close to the liferaft and embarkation ladder they are intended to serve, under charge. When disconnected from the ship's power, the lamp should give a minimum duration of 3 h of undiminished performance. The lamps should comply with the requirements of section 1.2.3 of the LSA Code. The lamps (i.e. luminaires) should meet the requirements of Ingress Protection rating IP 55. The batteries for the subject lamps should comply with IACS Unified Requirement (UR) E18 requirements irrespective of whether the expiry date is marked by the manufacturer or not.
- 7.3 With regard to the distance between the embarkation station and stowage location of the liferaft as required by SOLAS regulation III/31.1.4 (remotely located survival craft), the embarkation station should be so arranged that the requirements of regulation III/13.1.3 can be satisfied.
- 7.4 Exceptionally, the embarkation station and stowage position of the liferaft (remotely located survival craft) may be located on different decks provided that the liferaft can be launched from the stowage deck using the attached painter to relocate it to the embarkation ladder positioned on the other deck (traversing a stairway between different decks with the liferaft carried by crew members is not acceptable).
- 7.5 Notwithstanding paragraph 7.2, where the exceptional cases mentioned in paragraph 7.4 exist, the following provisions should be applied:
- .1 the lifejackets and the immersion suits required by paragraph 7.2.1 may be stowed at the embarkation station;

* Controlled manner: a knotted rope is not acceptable for this purpose.

- .2 adequate means of illumination complying with paragraph 7.2.2 should also illuminate the liferaft stowage position, embarkation station and area of water where the liferaft is to be embarked;
- .3 the embarkation ladder or other means of embarkation as required by paragraph 7.2.3 may be stowed at the embarkation station; and
- .4 notwithstanding the requirements in paragraph 4.1.3.2 of the LSA Code, the painter should be long enough to reach the relevant embarkation station.

8 Survival craft and rescue boats

(Source: MSC-MEPC.2/Circ.10)

Reg. 31.1.8 8.1 For single-hull oil tanker conversion into double-hull oil tanker, this regulation is not relevant.

8.2 For single-hull oil tanker conversion into bulk carrier, it is recommended that SOLAS regulation III/31.1.8 should be met as for new ships, except where the space available for fitting and/or launching a free-fall lifeboat in accordance with regulation III/31.1.2.1 is not adequate, in which case the existing arrangements for lifeboats are acceptable subject to compliance with SOLAS regulation III/1.4.2.

III

Chapter IV

Radiocommunications

Chapter IV Radiocommunications

Part A	General	
Regulation 1	Application	331
Regulation 2	Terms and definitions.	331
Regulation 3	Exemptions	332
Regulation 4	Functional requirements	333
Regulation 4-1	GMDSS satellite providers	333
Part B	Undertakings by Contracting Governments	
Regulation 5	Provision of radiocommunication services	334
Regulation 5-1	Global Maritime Distress and Safety System identities	334
Part C	Ship requirements	
Regulation 6	Radio installations	335
Regulation 7	Radio equipment: General.	336
Regulation 8	Radio equipment: Sea area A1	337
Regulation 9	Radio equipment: Sea areas A1 and A2	337
Regulation 10	Radio equipment: Sea areas A1, A2 and A3	338
Regulation 11	Radio equipment: Sea areas A1, A2, A3 and A4.	339
Regulation 12	Watches	340
Regulation 13	Sources of energy	340
Regulation 14	Performance standards	342
Regulation 15	Maintenance requirements.	342
Regulation 16	Radio personnel	343
Regulation 17	Radio records	343
Regulation 18	Position-updating.	344
Unified Interpretations for Chapter IV		345



Part A

General

Regulation 1

Application

- 1 Unless expressly provided otherwise, this chapter applies to all ships to which the present regulations apply and to cargo ships of 300 gross tonnage and upwards.
- 2 This chapter does not apply to ships to which the present regulations would otherwise apply while such ships are being navigated within the Great Lakes of North America and their connecting and tributary waters as far east as the lower exit of the St Lambert Lock at Montreal in the Province of Quebec, Canada.*
- 3 No provision in this chapter shall prevent the use by any ship, survival craft or person in distress, of any means at their disposal to attract attention, make known their position and obtain help.

Regulation 2

Terms and definitions

- 1 For the purpose of this chapter, the following terms shall have the meanings defined below:
 - .1 *Bridge-to-bridge communications* means safety communications between ships from the position from which the ships are normally navigated.
 - .2 *Continuous watch* means that the radio watch concerned shall not be interrupted other than for brief intervals when the ship's receiving capability is impaired or blocked by its own communications or when the facilities are under periodical maintenance or checks.
 - .3 *Digital selective calling (DSC)* means a technique using digital codes which enables a radio station to establish contact with, and transfer information to, another station or group of stations, and complying with the relevant recommendations of the International Radio Consultative Committee (CCIR).†
 - .4 *Direct-printing telegraphy* means automated telegraphy techniques which comply with the relevant recommendations of the International Radio Consultative Committee (CCIR).†
 - .5 *General radiocommunications* means operational and public correspondence traffic, other than distress, urgency and safety messages, conducted by radio.
 - .6 *Inmarsat‡* means the Organization established by the Convention on the International Maritime Satellite Organization adopted on 3 September 1976.

* Such ships are subject to special requirements relative to radio for safety purposes, as contained in the relevant agreement between Canada and the United States of America.

† The name of the Committee was changed to "ITU Radiocommunication Sector" (ITU-R) due to Article 1 of the International Telecommunication Constitution, Geneva, 1992.

‡ The name of the Organization was changed to "International Mobile Satellite Organization" (Inmarsat) by virtue of amendments to its Convention and Operating Agreement adopted by the 10th (extraordinary) Assembly (5 to 9 December 1994).

- IV**
- .7 *International NAVTEX Service* means the coordinated broadcast and automatic reception on 518 kHz of maritime safety information by means of narrow-band direct-printing telegraphy using the English language.*
 - .8 *Locating* means the finding of ships, aircraft, units or persons in distress.
 - .9 *Maritime safety information* means navigational and meteorological warnings, meteorological forecasts and other urgent safety-related messages broadcast to ships.
 - .10 *Polar orbiting satellite service* means a service which is based on polar orbiting satellites which receive and relay distress, alerts from satellite EPIRBs and which provides their position.
 - .11 *Radio Regulations* means the Radio Regulations annexed to, or regarded as being annexed to, the most recent International Telecommunication Convention which is in force at any time.
 - .12 *Sea area A1* means an area within the radiotelephone coverage of at least one VHF coast station in which continuous DSC alerting is available, as may be defined by a Contracting Government.†
 - .13 *Sea area A2* means an area, excluding sea area A1, within the radiotelephone coverage of at least one MF coast station in which continuous DSC alerting is available, as may be defined by a Contracting Government.†
 - .14 *Sea area A3* means an area, excluding sea areas A1 and A2, within the coverage of an Inmarsat geostationary satellite in which continuous alerting is available.
 - .15 *Sea area A4* means an area outside sea areas A1, A2 and A3.
 - .16 *Global Maritime Distress and Safety System (GMDSS) identities* means maritime mobile services identity, the ship's call sign, recognized mobile satellite service identities and serial number identity which may be transmitted by the ship's equipment and used to identify the ship.
 - .17 *Recognized mobile satellite service* means any service which operates through a satellite system and is recognized by the Organization, for use in the Global Maritime Distress and Safety System (GMDSS).

2 All other terms and abbreviations which are used in this chapter and which are defined in the Radio Regulations and in the International Convention on Maritime Search and Rescue (SAR), 1979, as may be amended, shall have the meanings as defined in those Regulations and the SAR Convention.

Regulation 3

Exemptions

1 The Contracting Governments consider it highly desirable not to deviate from the requirements of this chapter; nevertheless the Administration may grant partial or conditional exemptions to individual ships from the requirements of regulations 7 to 11 provided:

- .1 such ships comply with the functional requirements of regulation 4; and
- .2 the Administration has taken into account the effect such exemptions may have upon the general efficiency of the service for the safety of all ships.

2 An exemption may be granted under paragraph 1 only:

- .1 if the conditions affecting safety are such as to render the full application of regulations 7 to 11 unreasonable or unnecessary;
- .2 in exceptional circumstances, for a single voyage outside the sea area or sea areas for which the ship is equipped.

* Refer to the *NAVTEX Manual*.

† Refer to *Provision of radio services for the Global Maritime Distress and Safety System (GMDSS)* (resolution A.801(19), as amended).

3 Each Administration shall submit to the Organization, as soon as possible after the first of January in each year, a report showing all exemptions granted under paragraphs 1 and 2 during the previous calendar year and giving the reasons for granting such exemptions.

Regulation 4

*Functional requirements**

- 1 Every ship, while at sea, shall be capable:
 - .1 except as provided in regulations 8.1.1 and 10.1.4.3, of transmitting ship-to-shore distress alerts by at least two separate and independent means, each using a different radiocommunication service;
 - .2 of receiving shore-to-ship distress alerts;
 - .3 of transmitting and receiving ship-to-ship distress alerts;
 - .4 of transmitting and receiving search and rescue coordinating communications;
 - .5 of transmitting and receiving on-scene communications;
 - .6 of transmitting and, as required by regulation V/19.2.3.2, receiving signals for locating;†
 - .7 of transmitting and receiving‡ maritime safety information;
 - .8 of transmitting and receiving general radiocommunications to and from shore-based radio systems or networks subject to regulation 15.8; and
 - .9 of transmitting and receiving bridge-to-bridge communications.

Regulation 4-1

GMDSS satellite providers

The Maritime Safety Committee shall determine the criteria, procedures and arrangements for the evaluation, recognition, review and oversight of the provision of mobile satellite communication services in the Global Maritime Distress and Safety System (GMDSS) pursuant to the provisions of this chapter.§

* It should be noted that ships performing GMDSS functions should use *Guidance for the avoidance of false distress alerts* (resolution A.814(19)).

† Refer to *Carriage of radar operating in the frequency band 9,300–9,500 MHz* (resolution A.614(15)).

‡ It should be noted that ships may have a need for reception of certain maritime safety information while in port.

§ Refer to *Criteria for the provision of mobile satellite communication systems in the Global Maritime Distress and Safety System (GMDSS)* (resolution A.1001(25)) and *Guidance to prospective GMDSS satellite service providers* (MSC.1/Circ.1414).

Part B

Undertakings by Contracting Governments*

Regulation 5

Provision of radiocommunication services

1 Each Contracting Government undertakes to make available, as it deems practical and necessary either individually or in cooperation with other Contracting Governments, appropriate shore-based facilities for space and terrestrial radiocommunication services having due regard to the recommendations of the Organization.[†] These services are:

- .1 a radiocommunication service utilizing geostationary satellites in the maritime mobile-satellite service;
- .2 a radiocommunication service utilizing polar orbiting satellites in the mobile-satellite service;
- .3 the maritime mobile service in the bands between 156 MHz and 174 MHz;
- .4 the maritime mobile service in the bands between 4,000 kHz and 27,500 kHz; and
- .5 the maritime mobile service in the bands between 415 kHz and 535 kHz[‡] and between 1,605 kHz and 4,000 kHz.

2 Each Contracting Government undertakes to provide the Organization with pertinent information concerning the shore-based facilities in the maritime mobile service, mobile-satellite service and maritime mobile-satellite service, established for sea areas which it has designated off its coasts.[§]

Regulation 5-1

Global Maritime Distress and Safety System identities

1 This regulation applies to all ships on all voyages.

2 Each Contracting Government undertakes to ensure that suitable arrangements are made for registering Global Maritime Distress and Safety System (GMDSS) identities and for making information on these identities available to rescue coordination centres on a 24-hour basis. Where appropriate, international organizations maintaining a registry of these identities shall be notified by the Contracting Government of these assignments.

* 1 Each Contracting Government is not required to provide all radiocommunication services.

2 The requirements should be specified for shore-based facilities to cover the various sea areas.

[†] Refer to *Provision of radio services for the Global Maritime Distress and Safety System (GMDSS)* (resolution A.801(19), as amended).

[‡] Refer to *Implementation of the NAVTEX system as a component of the World-Wide Navigational Warning Service* (resolution A.617(15)).

[§] The Master Plan of shore-based facilities for the GMDSS based on information provided by Contracting Governments is included in the Organization's Global Integrated Shipping Information System (GISIS).

Part C

Ship requirements

Regulation 6

Radio installations

- 1 Every ship shall be provided with radio installations capable of complying with the functional requirements prescribed by regulation 4 throughout its intended voyage and, unless exempted under regulation 3, complying with the requirements of regulation 7 and, as appropriate for the sea area or areas through which it will pass during its intended voyage, the requirements of either regulation 8, 9, 10 or 11.
- 2 Every radio installation shall:
 - .1 be so located that no harmful interference of mechanical, electrical or other origin affects its proper use, and so as to ensure electromagnetic compatibility and avoidance of harmful interaction with other equipment and systems;
 - .2 be so located as to ensure the greatest possible degree of safety and operational availability;
 - .3 be protected against harmful effects of water, extremes of temperature and other adverse environmental conditions;
 - .4 be provided with reliable, permanently arranged electrical lighting, independent of the main and emergency sources of electrical power, for the adequate illumination of the radio controls for operating the radio installation; and
 - .5 be clearly marked with the call sign, the ship station identity and other codes as applicable for the use of the radio installation.
- 3 Control of the VHF radiotelephone channels, required for navigational safety, shall be immediately available on the navigation bridge convenient to the conning position and, where necessary, facilities should be available to permit radiocommunications from the wings of the navigation bridge. Portable VHF equipment may be used to meet the latter provision.
- 4 In passenger ships, a distress panel shall be installed at the conning position. This panel shall contain either one single button which, when pressed, initiates a distress alert using all radiocommunication installations required on board for that purpose or one button for each individual installation. The panel shall clearly and visually indicate whenever any button or buttons have been pressed. Means shall be provided to prevent inadvertent activation of the button or buttons. If the satellite EPIRB is used as the secondary means of distress alerting and is not remotely activated, it shall be acceptable to have an additional EPIRB installed in the wheelhouse near the conning position.
- 5 In passenger ships, information on the ship's position shall be continuously and automatically provided to all relevant radiocommunication equipment to be included in the initial distress alert when the button or buttons on the distress panel is pressed.
- 6 In passenger ships, a distress alarm panel shall be installed at the conning position. The distress alarm panel shall provide visual and aural indication of any distress alert or alerts received on board and shall also indicate through which radiocommunication service the distress alerts have been received.

Regulation 7

Radio equipment: General

1 Every ship shall be provided with:

.1 a VHF radio installation capable of transmitting and receiving:

- .1 DSC on the frequency 156.525 MHz (channel 70). It shall be possible to initiate the transmission of distress alerts on channel 70 from the position from which the ship is normally navigated;* and
- .2 radiotelephony on the frequencies 156.300 MHz (channel 6), 156.650 MHz (channel 13) and 156.800 MHz (channel 16);

.2 a radio installation capable of maintaining a continuous DSC watch on VHF channel 70 which may be separate from, or combined with, that required by subparagraph 1.1;*

.3 a search and rescue locating device capable of operating either in the 9 GHz band or on frequencies dedicated for AIS, which:

- .1 shall be so stowed that it can be easily utilized; and
- .2 may be one of those required by regulation III/6.2.2 for a survival craft;

.4 a receiver capable of receiving international NAVTEX service broadcasts if the ship is engaged on voyages in any area in which an international NAVTEX service is provided;

.5 a radio facility for reception of maritime safety information by a recognized mobile satellite service enhanced group calling system if the ship is engaged on voyages in sea area A1, or A2 or A3 but in which an international NAVTEX service is not provided. However, ships engaged exclusively on voyages in areas where an HF direct-printing telegraphy maritime safety information service is provided and fitted with equipment capable of receiving such service, may be exempt from this requirement;†

.6 subject to the provisions of regulation 8.3, a satellite emergency position-indicating radio beacon (satellite EPIRB)‡ which shall be:

- .1 capable of transmitting a distress alert through the polar orbiting satellite service operating in the 406 MHz band;
- .2 installed in an easily accessible position;
- .3 ready to be manually released and capable of being carried by one person into a survival craft;
- .4 capable of floating free if the ship sinks and of being automatically activated when afloat; and
- .5 capable of being activated manually.

2 Every passenger ship shall be provided with means for two-way on-scene radiocommunications for search and rescue purposes using the aeronautical frequencies 121.5 MHz and 123.1 MHz from the position from which the ship is normally navigated.

* Certain ships may be exempted from this requirement (see regulation IV/9.4).

† Refer to the *Recommendation on promulgation of maritime safety information* adopted by the Organization by resolution A.705(17), as amended.

‡ Refer to *Search and rescue homing capability* (resolution A.616(15)).

Regulation 8

Radio equipment: Sea area A1

1 In addition to meeting the requirements of regulation 7, every ship engaged on voyages exclusively in sea area A1 shall be provided with a radio installation capable of initiating the transmission of ship-to-shore distress alerts from the position from which the ship is normally navigated, operating either:

- .1 on VHF using DSC; this requirement may be fulfilled by the EPIRB prescribed by paragraph 3, either by installing the EPIRB close to, or by remote activation from, the position from which the ship is normally navigated; or
- .2 through the polar orbiting satellite service on 406 MHz; this requirement may be fulfilled by the satellite EPIRB, required by regulation 7.1.6, either by installing the satellite EPIRB close to, or by remote activation from, the position from which the ship is normally navigated; or
- .3 if the ship is engaged on voyages within coverage of MF coast stations equipped with DSC, on MF using DSC; or
- .4 on HF using DSC; or
- .5 through a recognized mobile satellite service; this requirement may be fulfilled by:
 - .1 a ship earth station;* or
 - .2 the satellite EPIRB, required by regulation 7.1.6, either by installing the satellite EPIRB close to, or by remote activation from, the position from which the ship is normally navigated.

2 The VHF radio installation, required by regulation 7.1.1, shall also be capable of transmitting and receiving general radiocommunications using radiotelephony.

3 Ships engaged on voyages exclusively in sea area A1 may carry, in lieu of the satellite EPIRB required by regulation 7.1.6, an EPIRB which shall be:

- .1 capable of transmitting a distress alert using DSC on VHF channel 70 and providing for locating by means of a radar transponder operating in the 9 GHz band;
- .2 installed in an easily accessible position;
- .3 ready to be manually released and capable of being carried by one person into a survival craft;
- .4 capable of floating free if the ship sinks and being automatically activated when afloat; and
- .5 capable of being activated manually.

Regulation 9

Radio equipment: Sea areas A1 and A2

1 In addition to meeting the requirements of regulation 7, every ship engaged on voyages beyond sea area A1, but remaining within sea area A2, shall be provided with:

- .1 an MF radio installation capable of transmitting and receiving, for distress and safety purposes, on the frequencies:
 - .1 2,187.5 kHz using DSC; and
 - .2 2,182 kHz using radiotelephony;

* This requirement can be met by recognized mobile satellite service ship earth stations capable of two-way communications, such as Fleet-77 (resolutions A.808(19) and MSC.130(75)) or Inmarsat-C (resolution A.807(19), as amended) ship earth stations. Unless otherwise specified, this footnote applies to all requirements for a recognized mobile satellite service ship earth station prescribed by this chapter.

- .2 a radio installation capable of maintaining a continuous DSC watch on the frequency 2,187.5 kHz which may be separate from, or combined with, that required by subparagraph .1.1; and
- .3 means of initiating the transmission of ship-to-shore distress alerts by a radio service other than MF operating either:
 - .1 through the polar orbiting satellite service on 406 MHz; this requirement may be fulfilled by the satellite EPIRB, required by regulation 7.1.6, either by installing the satellite EPIRB close to, or by remote activation from, the position from which the ship is normally navigated; or
 - .2 on HF using DSC; or
 - .3 through a recognized mobile satellite service by a ship earth station.

2 It shall be possible to initiate transmission of distress alerts by the radio installations specified in paragraphs 1.1 and 1.3 from the position from which the ship is normally navigated.

3 The ship shall, in addition, be capable of transmitting and receiving general radiocommunications using radiotelephony or direct-printing telegraphy by either:

- .1 a radio installation operating on working frequencies in the bands between 1,605 kHz and 4,000 kHz or between 4,000 kHz and 27,500 kHz. This requirement may be fulfilled by the addition of this capability in the equipment required by paragraph 1.1; or
- .2 a recognized mobile satellite service ship earth station.

4 The Administration may exempt ships constructed before 1 February 1997, which are engaged exclusively on voyages within sea area A2, from the requirements of regulations 7.1.1.1 and 7.1.2 provided such ships maintain, when practicable, a continuous listening watch on VHF channel 16. This watch shall be kept at the position from which the ship is normally navigated.

Regulation 10

Radio equipment: Sea areas A1, A2 and A3

1 In addition to meeting the requirements of regulation 7, every ship engaged on voyages beyond sea areas A1 and A2, but remaining within sea area A3, shall, if it does not comply with the requirements of paragraph 2, be provided with:

- .1 a recognized mobile satellite service ship earth station capable of:
 - .1 transmitting and receiving distress and safety communications using direct-printing telegraphy;
 - .2 initiating and receiving distress priority calls;
 - .3 maintaining watch for shore-to-ship distress alerts, including those directed to specifically defined geographical areas;
 - .4 transmitting and receiving general radiocommunications, using either radiotelephony or direct-printing telegraphy; and
- .2 an MF radio installation capable of transmitting and receiving, for distress and safety purposes, on the frequencies:
 - .1 2,187.5 kHz using DSC; and
 - .2 2,182 kHz using radiotelephony; and
- .3 a radio installation capable of maintaining a continuous DSC watch on the frequency 2,187.5 kHz which may be separate from or combined with that required by subparagraph .2.1; and

- .4 means of initiating the transmission of ship-to-shore distress alerts by a radio service operating either:
 - .1 through the polar orbiting satellite service on 406 MHz; this requirement may be fulfilled by the satellite EPIRB, required by regulation 7.1.6, either by installing the satellite EPIRB close to, or by remote activation from, the position from which the ship is normally navigated; or
 - .2 on HF using DSC; or
 - .3 through a recognized mobile satellite service by an additional ship earth station.

2 In addition to meeting the requirements of regulation 7, every ship engaged on voyages beyond sea areas A1 and A2, but remaining within sea area A3, shall, if it does not comply with the requirements of paragraph 1, be provided with:

- .1 an MF/HF radio installation capable of transmitting and receiving, for distress and safety purposes, on all distress and safety frequencies in the bands between 1,605 kHz and 4,000 kHz and between 4,000 kHz and 27,500 kHz:
 - .1 using DSC;
 - .2 using radiotelephony; and
 - .3 using direct-printing telegraphy; and
- .2 equipment capable of maintaining DSC watch on 2,187.5 kHz, 8,414.5 kHz and on at least one of the distress and safety DSC frequencies 4,207.5 kHz, 6,312 kHz, 12,577 kHz or 16,804.5 kHz; at any time, it shall be possible to select any of these DSC distress and safety frequencies. This equipment may be separate from, or combined with, the equipment required by subparagraph .1; and
- .3 means of initiating the transmission of ship-to-shore distress alerts by a radiocommunication service other than HF operating either:
 - .1 through the polar orbiting satellite service on 406 MHz; this requirement may be fulfilled by the satellite EPIRB, required by regulation 7.1.6, either by installing the satellite EPIRB close to, or by remote activation from, the position from which the ship is normally navigated; or
 - .2 through a recognized mobile satellite service by a ship earth station; and
- .4 in addition, ships shall be capable of transmitting and receiving general radiocommunications using radiotelephony or direct-printing telegraphy by an MF/HF radio installation operating on working frequencies in the bands between 1,605 kHz and 4,000 kHz and between 4,000 kHz and 27,500 kHz. This requirement may be fulfilled by the addition of this capability in the equipment required by subparagraph .1.

3 It shall be possible to initiate transmission of distress alerts by the radio installations specified in paragraphs 1.1, 1.2, 1.4, 2.1 and 2.3 from the position from which the ship is normally navigated.

4 The Administration may exempt ships constructed before 1 February 1997, and engaged exclusively on voyages within sea areas A2 and A3, from the requirements of regulations 7.1.1.1 and 7.1.2 provided such ships maintain, when practicable, a continuous listening watch on VHF channel 16. This watch shall be kept at the position from which the ship is normally navigated.

Regulation 11

Radio equipment: Sea areas A1, A2, A3 and A4

1 In addition to meeting the requirements of regulation 7, ships engaged on voyages in all sea areas shall be provided with the radio installations and equipment required by regulation 10.2, except that the equipment required by regulation 10.2.3.2 shall not be accepted as an alternative to that required by regulation 10.2.3.1, which shall always be provided. In addition, ships engaged on voyages in all sea areas shall comply with the requirements of regulation 10.3.

2 The Administration may exempt ships constructed before 1 February 1997, and engaged exclusively on voyages within sea areas A2, A3 and A4, from the requirements of regulations 7.1.1.1 and 7.1.2 provided such ships maintain, when practicable, a continuous listening watch on VHF channel 16. This watch shall be kept at the position from which the ship is normally navigated.

Regulation 12

Watches

- 1 Every ship, while at sea, shall maintain a continuous watch:
- .1 on VHF DSC channel 70, if the ship, in accordance with the requirements of regulation 7.1.2, is fitted with a VHF radio installation;
 - .2 on the distress and safety DSC frequency 2,187.5 kHz, if the ship, in accordance with the requirements of regulation 9.1.2 or 10.1.3, is fitted with an MF radio installation;
 - .3 on the distress and safety DSC frequencies 2,187.5 kHz and 8,414.5 kHz and also on at least one of the distress and safety DSC frequencies 4,207.5 kHz, 6,312 kHz, 12,577 kHz or 16,804.5 kHz, appropriate to the time of day and the geographical position of the ship, if the ship, in accordance with the requirements of regulation 10.2.2 or 11.1, is fitted with an MF/HF radio installation. This watch may be kept by means of a scanning receiver;
 - .4 for satellite shore-to-ship distress alerts, if the ship, in accordance with the requirements of regulation 10.1.1, is fitted with a recognized mobile satellite service ship earth station.
- 2 Every ship, while at sea, shall maintain a radio watch for broadcasts of maritime safety information on the appropriate frequency or frequencies on which such information is broadcast for the area in which the ship is navigating.
- 3 Until 1 February 1999 or until such other date as may be determined by the Maritime Safety Committee,* every ship while at sea shall maintain, when practicable, a continuous listening watch on VHF channel 16. This watch shall be kept at the position from which the ship is normally navigated.

Regulation 13

Sources of energy

- 1 There shall be available at all times, while the ship is at sea, a supply of electrical energy sufficient to operate the radio installations and to charge any batteries used as part of a reserve source or sources of energy for the radio installations.
- 2 A reserve source or sources of energy shall be provided on every ship, to supply radio installations, for the purpose of conducting distress and safety radiocommunications, in the event of failure of the ship's main and emergency sources of electrical power. The reserve source or sources of energy shall be capable of simultaneously operating the VHF radio installation required by regulation 7.1.1 and, as appropriate for the sea area or sea areas for which the ship is equipped, either the MF radio installation required by regulation 9.1.1, the MF/HF radio installation required by regulation 10.2.1 or 11.1, or the ship earth station required by regulation 10.1.1 and any of the additional loads mentioned in paragraphs 4, 5 and 8 for a period of at least:
- .1 1 h on ships provided with an emergency source of electrical power, if such source of power complies fully with all relevant provisions of regulation II-1/42 or 43, including the supply of such power to the radio installations; and

* Refer to *Maintenance of a continuous listening watch on VHF channel 16 by SOLAS ships whilst at sea after 1 February 1999 and installation of VHF DSC facilities on non-SOLAS ships* (resolution MSC.131(75)).

- .2 6 h on ships not provided with an emergency source of electrical power complying fully with all relevant provisions of regulation II-1/42 or 43, including the supply of such power to the radio installations.*

The reserve source or sources of energy need not supply independent HF and MF radio installations at the same time.

3 The reserve source or sources of energy shall be independent of the propelling power of the ship and the ship's electrical system.

4 Where, in addition to the VHF radio installation, two or more of the other radio installations, referred to in paragraph 2, can be connected to the reserve source or sources of energy, they shall be capable of simultaneously supplying, for the period specified, as appropriate, in paragraph 2.1 or 2.2, the VHF radio installation and:

- .1 all other radio installations which can be connected to the reserve source or sources of energy at the same time; or
- .2 whichever of the other radio installations will consume the most power, if only one of the other radio installations can be connected to the reserve source or sources of energy at the same time as the VHF radio installation.

5 The reserve source or sources of energy may be used to supply the electrical lighting required by regulation 6.2.4.

6 Where a reserve source of energy consists of a rechargeable accumulator battery or batteries:

- .1 a means of automatically charging such batteries shall be provided which shall be capable of recharging them to minimum capacity requirements within 10 h; and
- .2 the capacity of the battery or batteries shall be checked, using an appropriate method,† at intervals not exceeding 12 months, when the ship is not at sea.

7 The siting and installation of accumulator batteries which provide a reserve source of energy shall be such as to ensure:

- .1 the highest degree of service;
- .2 a reasonable lifetime;
- .3 reasonable safety;
- .4 that battery temperatures remain within the manufacturer's specifications whether under charge or idle; and
- .5 that when fully charged, the batteries will provide at least the minimum required hours of operation under all weather conditions.

8 If an uninterrupted input of information from the ship's navigational or other equipment to a radio installation required by this chapter, including the navigation receiver referred to in regulation 18, is needed to ensure its proper performance, means shall be provided to ensure the continuous supply of such information in the event of failure of the ship's main or emergency source of electrical power.

* For guidance, the following formula is recommended for determining the electrical load to be supplied by the reserve source of energy for each radio installation required for distress conditions: $1/2$ of the current consumption necessary for transmission + the current consumption necessary for reception + the current consumption of any additional loads.

† One method of checking the capacity of an accumulator battery is to fully discharge and recharge the battery, using normal operating current and period (e.g. 10 h). Assessment of the charge condition can be made at any time, but it should be done without significant discharge of the battery when the ship is at sea.

Regulation 14

Performance standards

1 All equipment to which this chapter applies shall be of a type approved by the Administration. Such equipment shall conform to appropriate performance standards not inferior to those adopted by the Organization.*

Regulation 15

Maintenance requirements

1 Equipment shall be so designed that the main units can be replaced readily, without elaborate recalibration or readjustment.

2 Where applicable, equipment shall be so constructed and installed that it is readily accessible for inspection and on-board maintenance purposes.

3 Adequate information shall be provided to enable the equipment to be properly operated and maintained, taking into account the recommendations of the Organization.†

4 Adequate tools and spares shall be provided to enable the equipment to be maintained.

5 The Administration shall ensure that radio equipment required by this chapter is maintained to provide the availability of the functional requirements specified in regulation 4 and to meet the recommended performance standards of such equipment.

* Refer to:

- 1 *Revised Performance standards for narrow-band direct-printing telegraph equipment for the reception of navigational and meteorological warnings and urgent information to ships (NAVTEX)* (resolution MSC.148(77), as amended).
- 2 *General requirements for shipborne radio equipment forming part of the global maritime distress and safety system (GMDSS) and for electronic navigational aids* (resolution A.694(17)).
- 3 *Performance standards for ship earth stations capable of two-way communications* (resolution A.808(19)); *Type approval of ship earth stations* (resolution A.570(14)); *Performance standards for Inmarsat ship earth stations capable of two-way communications* (resolution MSC.130(75)); and *Performance standards for a ship earth station for use in the GMDSS* (resolution MSC.434(98)).
- 4 *Performance standards for shipborne VHF radio installations capable of voice communication and digital selective calling* (resolution A.803(19), as amended).
- 5 *Performance standards for shipborne MF radio installations capable of voice communication and digital selective calling* (resolution A.804(19), as amended).
- 6 *Performance standards for shipborne MF/HF radio installations capable of voice communication, narrow-band direct-printing and digital selective calling* (resolution A.806(19), as amended).
- 7 *Performance standards for float-free satellite emergency position-indicating radio beacons (EPIRBs) operating on 406 MHz* (resolution A.810(19), as amended); *Type approval of satellite emergency position-indicating radio beacons (EPIRBs) operating in the Cospas-Sarsat system* (resolution A.696(17)); and *Performance standards for float-free emergency position-indicating radio beacons (EPIRBs) operating on 406 MHz* (resolution MSC.471(101)).
- 8 *Performance standards for survival craft radar transponders for use in search and rescue operations* (resolution A.802(19), as amended).
- 9 *Performance standards for float-free VHF emergency position-indicating radio beacons* (resolution A.805(19)).
- 10 *Performance standards for Inmarsat-C ship earth stations capable of transmitting and receiving direct-printing communications* (resolution A.807(19), as amended).
- 11 *Revised Performance standards for enhanced group call (EGC) equipment* (resolution MSC.306(87), as amended).
- 12 *Performance standards for float-free release and activation arrangements for emergency radio equipment* (resolution A.662(16)).
- 13 *System performance standard for the promulgation and co-ordination of maritime safety information using high-frequency narrow-band direct printing* (resolution A.699(17)).
- 14 *Performance standards for a shipborne integrated radio-communication system (IRCS) when used in the GMDSS* (resolution A.811(19)).
- 15 *Performance standards for on-scene (aeronautical) two-way portable VHF radiotelephone apparatus* (resolution MSC.80(70), annex 1).

† Refer to *Recommendation on general requirements for shipborne radio equipment forming part of the global maritime distress and safety system and for electronic navigational aids* (resolution A.694(17)), *General requirements for electromagnetic compatibility (EMC) for all electrical and electronic ship's equipment* (resolution A.813(19)), and *Clarifications of certain requirements in IMO performance standards for GMDSS equipment* (MSC/Circ.862).

6 On ships engaged on voyages in sea areas A1 and A2, the availability shall be ensured by using such methods as duplication of equipment, shore-based maintenance or at-sea electronic maintenance capability, or a combination of these, as may be approved by the Administration.

7 On ships engaged on voyages in sea areas A3 and A4, the availability shall be ensured by using a combination of at least two methods such as duplication of equipment, shore-based maintenance or at-sea electronic maintenance capability, as may be approved by the Administration, taking into account the recommendations of the Organization.*

8 While all reasonable steps shall be taken to maintain the equipment in efficient working order to ensure compliance with all the functional requirements specified in regulation 4, malfunction of the equipment for providing the general radiocommunications required by regulation 4.8 shall not be considered as making a ship unseaworthy or as a reason for delaying the ship in ports where repair facilities are not readily available, provided the ship is capable of performing all distress and safety functions.

9 Satellite EPIRBs shall be:

- .1 annually tested for all aspects of operational efficiency, with special emphasis on checking the emission on operational frequencies, coding and registration, at intervals as specified below:
 - .1 on passenger ships, within 3 months before the expiry date of the Passenger Ship Safety Certificate; and
 - .2 on cargo ships, within 3 months before the expiry date, or 3 months before or after the anniversary date, of the Cargo Ship Safety Radio Certificate.

The test may be conducted on board the ship or at an approved testing station; and

- .2 subject to maintenance at intervals not exceeding five years, to be performed at an approved shore-based maintenance facility.

SEE INTERPRETATION 1

Regulation 16

Radio personnel

1 Every ship shall carry personnel qualified for distress and safety radiocommunication purposes to the satisfaction of the Administration.† The personnel shall be holders of certificates specified in the Radio Regulations as appropriate, any one of whom shall be designated to have primary responsibility for radiocommunications during distress incidents.

2 In passenger ships, at least one person qualified in accordance with paragraph 1 shall be assigned to perform only radiocommunication duties during distress incidents.

Regulation 17

Radio records

A record shall be kept, to the satisfaction of the Administration and as required by the Radio Regulations, of all incidents connected with the radiocommunication service which appear to be of importance to safety of life at sea.

* Refer to *Radio maintenance guidelines for the global maritime distress and safety system related to sea areas A3 and A4* (resolution A.702(17)).

† Refer to the STCW Code, chapter IV, section B-IV/2.

Regulation 18

Position-updating

All two-way communication equipment carried on board a ship to which this chapter applies which is capable of automatically including the ship's position in the distress alert shall be automatically provided with this information from an internal or external navigation receiver, if either is installed. If such a receiver is not installed, the ship's position and the time at which the position was determined shall be manually updated at intervals not exceeding 4 h, while the ship is under way, so that it is always ready for transmission by the equipment.

Unified Interpretations for Chapter IV

1 Annual test of EPIRB

(Source: MSC.1/Circ.1576)

Reg. 15.9

The annual test of the EPIRBs shall be carried out within the "time window" of the prescribed survey, but not later than the date of completion of the survey for endorsement/renewal of the relevant Certificate.

Chapter V

Safety of navigation



Chapter V

Safety of navigation

Regulation 1	Application	351
Regulation 2	Definitions.	351
Regulation 3	Exemptions and equivalents.	352
Regulation 4	Navigational warnings	352
Regulation 5	Meteorological services and warnings	352
Regulation 6	Ice Patrol Service.	353
Regulation 7	Search and rescue services	354
Regulation 8	Life-saving signals	354
Regulation 9	Hydrographic services	355
Regulation 10	Ships' routing.	355
Regulation 11	Ship reporting systems.	356
Regulation 12	Vessel traffic services.	357
Regulation 13	Establishment and operation of aids to navigation.	357
Regulation 14	Ships' manning	358
Regulation 15	Principles relating to bridge design, design and arrangement of navigational systems and equipment and bridge procedures.	358
Regulation 16	Maintenance of equipment	359
Regulation 17	Electromagnetic compatibility	359
Regulation 18	Approval, surveys and performance standards of navigational systems and equipment and voyage data recorder	359
Regulation 19	Carriage requirements for shipborne navigational systems and equipment	361
Regulation 19-1	Long-range identification and tracking of ships	366
Regulation 20	Voyage data recorders.	369
Regulation 21	International Code of Signals and IAMSAR Manual	369
Regulation 22	Navigation bridge visibility.	370
Regulation 23	Pilot transfer arrangements.	371
Regulation 24	Use of heading and/or track control systems	373
Regulation 25	Operation of steering gear	374
Regulation 26	Steering gear: testing and drills.	374
Regulation 27	Nautical charts and nautical publications.	375
Regulation 28	Records of navigational activities and daily reporting	375
Regulation 29	Life-saving signals to be used by ships, aircraft or persons in distress.	375

Regulation 30	Operational limitations	375
Regulation 31	Danger messages	376
Regulation 32	Information required in danger messages	376
Regulation 33	Distress situations: obligations and procedures	378
Regulation 34	Safe navigation and avoidance of dangerous situations	379
Regulation 34-1	Master's discretion	379
Regulation 35	Misuse of distress signals	379
Appendix	Rules for the management, operation and financing of the North Atlantic Ice Patrol	380
Unified Interpretations for Chapter V		383

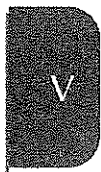

Regulation 1

Application

- 1 Unless expressly provided otherwise, this chapter shall apply to all ships on all voyages, except:
 - .1 warships, naval auxiliaries and other ships owned or operated by a Contracting Government and used only on government non-commercial service; and
 - .2 ships solely navigating the Great Lakes of North America and their connecting and tributary waters as far east as the lower exit of the St Lambert Lock at Montreal in the Province of Quebec, Canada.

However, warships, naval auxiliaries or other ships owned or operated by a Contracting Government and used only on government non-commercial service are encouraged to act in a manner consistent, so far as reasonable and practicable, with this chapter.

- 2 The Administration may decide to what extent this chapter shall apply to ships operating solely in waters landward of the baselines which are established in accordance with international law.
- 3 A rigidly connected composite unit of a pushing vessel and associated pushed vessel, when designed as a dedicated and integrated tug and barge combination, shall be regarded as a single ship for the purpose of this chapter.
- 4 The Administration shall determine to what extent the provisions of regulations 15, 16, 17, 18, 19, 20, 21, 22, 23, 24, 25, 26, 27 and 28 do not apply to the following categories of ships:
 - .1 ships below 150 gross tonnage engaged on any voyage;
 - .2 ships below 500 gross tonnage not engaged on international voyages; and
 - .3 fishing vessels.

Regulation 2

Definitions

For the purpose of this chapter:

- 1 *Constructed* in respect of a ship means a stage of construction where:
 - .1 the keel is laid; or
 - .2 construction identifiable with a specific ship begins; or
 - .3 assembly of the ship has commenced comprising at least 50 tonnes or 1% of the estimated mass of all structural material, whichever is less.
- 2 *Nautical chart or nautical publication* is a special-purpose map or book, or a specially compiled database from which such a map or book is derived, that is issued officially by or on the authority of a Government, authorized Hydrographic Office or other relevant government institution and is designed to meet the requirements of marine navigation.*
- 3 *All ships* means any ship, vessel or craft irrespective of type and purpose.
- 4 *Length* of a ship means its length overall.

* Refer to appropriate resolutions and recommendations of the International Hydrographic Organization concerning the authority and responsibilities of coastal States in the provision of charting in accordance with regulation 9.

5 *Search and rescue service.* The performance of distress monitoring, communication, coordination and search and rescue functions, including provision of medical advice, initial medical assistance, or medical evacuation, through the use of public and private resources including cooperating aircraft, ships, vessels and other craft and installations.

6 *High-speed craft* means a craft as defined in regulation X/1.3.

7 *Mobile offshore drilling unit* means a mobile offshore drilling unit as defined in regulation XI-2/1.1.5.

Regulation 3

Exemptions and equivalents

1 The Administration may grant general exemptions from the requirements of regulations 15, 17, 18, 19 (except 19.2.1.7), 20, 22, 24, 25, 26, 27 and 28 to ships without mechanical means of propulsion.

2 The Administration may grant to individual ships exemptions or equivalents of a partial or conditional nature, when any such ship is engaged on a voyage where the maximum distance of the ship from the shore, the length and nature of the voyage, the absence of general navigational hazards, and other conditions affecting safety are such as to render the full application of this chapter unreasonable or unnecessary, provided that the Administration has taken into account the effect such exemptions and equivalents may have upon the safety of all other ships.

3 Each Administration shall submit to the Organization, as soon as possible after 1 January in each year, a report summarizing all new exemptions and equivalents granted under paragraph 2 of this regulation during the previous calendar year and giving the reasons for granting such exemptions and equivalents. The Organization shall circulate such particulars to other Contracting Governments for information.

Regulation 4

Navigational warnings

Each Contracting Government shall take all steps necessary to ensure that, when intelligence of any dangers is received from whatever reliable source, it shall be promptly brought to the knowledge of those concerned and communicated to other interested Governments.*

Regulation 5

Meteorological services and warnings

1 Contracting Governments undertake to encourage the collection of meteorological data by ships at sea and to arrange for their examination, dissemination and exchange in the manner most suitable for the purpose of aiding navigation.† Administrations shall encourage the use of meteorological instruments of a high degree of accuracy and shall facilitate the checking of such instruments upon request. Arrangements may be made by appropriate national meteorological services for this checking to be undertaken, free of charge to the ship.

2 In particular, Contracting Governments undertake to carry out, in cooperation, the following meteorological arrangements:

- .1 To warn ships of gales, storms and tropical cyclones by the issue of information in text and, as far as practicable, graphic form, using the appropriate shore-based facilities for terrestrial and space radiocommunications services.

* Refer to Guidance on the IMO/IHO World-Wide Navigational Warning Service (resolution A.706(17), as amended).

† Refer to *Recommendation on weather routing* (resolution A.528(13)).

- .2 To issue, at least twice daily, by terrestrial and space radiocommunication services,* as appropriate, weather information suitable for shipping containing data, analyses, warnings and forecasts of weather, waves and ice. Such information shall be transmitted in text and, as far as practicable, graphic form, including meteorological analysis and prognosis charts transmitted by facsimile or in digital form for reconstitution on board the ship's data processing system.
- .3 To prepare and issue such publications as may be necessary for the efficient conduct of meteorological work at sea and to arrange, if practicable, for the publication and making available of daily weather charts for the information of departing ships.
- .4 To arrange for a selection of ships to be equipped with tested marine meteorological instruments (such as a barometer, a barograph, a psychrometer and suitable apparatus for measuring sea temperature) for use in this service, and to take, record and transmit meteorological observations at the main standard times for surface synoptic observations (i.e. at least four times daily, whenever circumstances permit) and to encourage other ships to take, record and transmit observations in a modified form, particularly when in areas where shipping is sparse.
- .5 To encourage companies to involve as many of their ships as practicable in the making and recording of weather observations; these observations to be transmitted using the ship's terrestrial or space radiocommunications facilities for the benefit of the various national meteorological services.
- .6 The transmission of these weather observations is free of charge to the ships concerned.
- .7 When in the vicinity of a tropical cyclone, or of a suspected tropical cyclone, ships should be encouraged to take and transmit their observations at more frequent intervals whenever practicable, bearing in mind navigational preoccupations of ships' officers during storm conditions.
- .8 To arrange for the reception and transmission of weather messages from and to ships, using the appropriate shore-based facilities for terrestrial and space radiocommunications services.
- .9 To encourage masters to inform ships in the vicinity and also shore stations whenever they experience a wind speed of 50 knots or more (force 10 on the Beaufort scale).
- .10 To endeavour to obtain a uniform procedure in regard to the international meteorological services already specified, and as far as practicable, to conform to the technical regulations and recommendations made by the World Meteorological Organization, to which Contracting Governments may refer, for study and advice, any meteorological question which may arise in carrying out the present Convention.

3 The information provided for in this regulation shall be furnished in a form for transmission and be transmitted in the order of priority prescribed by the Radio Regulations. During transmission "to all stations" of meteorological information, forecasts and warnings, all ship stations must conform to the provisions of the Radio Regulations.

4 Forecasts, warnings, synoptic and other meteorological data intended for ships shall be issued and disseminated by the national meteorological service in the best position to serve various coastal and high seas areas, in accordance with mutual arrangements made by Contracting Governments, in particular as defined by the World Meteorological Organization's system for the preparation and dissemination of meteorological forecasts and warnings for the high seas under the Global Maritime Distress and Safety System (GMDSS).

Regulation 6

Ice Patrol Service

1 The Ice Patrol contributes to safety of life at sea, safety and efficiency of navigation and protection of the marine environment in the North Atlantic. Ships transiting the region of icebergs guarded by the Ice Patrol during the ice season are required to make use of the services provided by the Ice Patrol.

* Refer to regulations IV/7.1.4 and IV/7.1.5.

2 The Contracting Governments undertake to continue an ice patrol and a service for study and observation of ice conditions in the North Atlantic. During the whole of the ice season, i.e. for the period from 15 February through 1 July of each year, the south-eastern, southern and south-western limits of the region of icebergs in the vicinity of the Grand Banks of Newfoundland shall be guarded for the purpose of informing passing ships of the extent of this dangerous region; for the study of ice conditions in general; and for the purpose of affording assistance to ships and crews requiring aid within the limits of operation of the patrol ships and aircraft. During the rest of the year the study and observation of ice conditions shall be maintained as advisable.

3 Ships and aircraft used for the Ice Patrol Service and the study and observation of ice conditions may be assigned other duties provided that such other duties do not interfere with the primary purpose or increase the cost of this service.

4 The Government of the United States of America agrees to continue the overall management of the Ice Patrol Service and the study and observation of ice conditions, including the dissemination of information therefrom.

5 The terms and conditions governing the management, operation and financing of the Ice Patrol are set forth in the Rules for the management, operation and financing of the North Atlantic Ice Patrol appended to this chapter, which shall form an integral part of this chapter.

6 If, at any time, the United States and/or Canadian Governments should desire to discontinue providing these services, it may do so and the Contracting Governments shall settle the question of continuing these services in accordance with their mutual interests. The United States and/or Canadian Governments shall provide 18 months' written notice to all Contracting Governments whose ships entitled to fly their flag and whose ships are registered in territories to which those Contracting Governments have extended this regulation benefit from these services before discontinuing providing these services.

Regulation 7

Search and rescue services

1 Each Contracting Government undertakes to ensure that necessary arrangements are made for distress communication and coordination in their area of responsibility and for the rescue of persons in distress at sea around its coasts. These arrangements shall include the establishment, operation and maintenance of such search and rescue facilities as are deemed practicable and necessary, having regard to the density of the seagoing traffic and the navigational dangers, and shall, so far as possible, provide adequate means of locating and rescuing such persons.*

2 Each Contracting Government undertakes to make available information to the Organization concerning its existing search and rescue facilities and the plans for changes therein, if any.

3 Passenger ships to which chapter I applies shall have on board a plan for cooperation with appropriate search and rescue services in the event of an emergency. The plan shall be developed in cooperation between the ship, the company, as defined in regulation IX/1, and the search and rescue services. The plan shall include provisions for periodic exercises to be undertaken to test its effectiveness. The plan shall be developed based on the guidelines developed by the Organization.

Regulation 8

Life-saving signals

Contracting Governments undertake to arrange that life-saving signals are used by search and rescue facilities engaged in search and rescue operations when communicating with ships or persons in distress.

* Refer to the International Convention on Maritime Search and Rescue (SAR), 1979, and to the following resolutions adopted by the Organization: *Homing capability of search and rescue (SAR) aircraft* (resolution A.225(VII)), *Use of radar transponders for search and rescue purposes* (resolution A.530(13)), *Search and rescue homing capability* (resolution A.616(15)) and *International Aeronautical and Maritime Search and Rescue (IAMSAR) Manual* (resolution A.894(21), as amended).

Regulation 9

Hydrographic services

- 1 Contracting Governments undertake to arrange for the collection and compilation of hydrographic data and the publication, dissemination and keeping up to date of all nautical information necessary for safe navigation.
- 2 In particular, Contracting Governments undertake to cooperate in carrying out, as far as possible, the following nautical and hydrographic services, in the manner most suitable for the purpose of aiding navigation:
 - .1 to ensure that hydrographic surveying is carried out, as far as possible, adequate to the requirements of safe navigation;
 - .2 to prepare and issue nautical charts, sailing directions, lists of lights, tide tables and other nautical publications, where applicable, satisfying the needs of safe navigation;
 - .3 to promulgate notices to mariners in order that nautical charts and publications are kept, as far as possible, up to date; and
 - .4 to provide data management arrangements to support these services.
- 3 Contracting Governments undertake to ensure the greatest possible uniformity in charts and nautical publications and to take into account, whenever possible, relevant international resolutions and recommendations.*
- 4 Contracting Governments undertake to coordinate their activities to the greatest possible degree in order to ensure that hydrographic and nautical information is made available on a world-wide scale as timely, reliably, and unambiguously as possible.

Regulation 10

Ships' routing

- 1 Ships' routing systems contribute to safety of life at sea, safety and efficiency of navigation and/or protection of the marine environment. Ships' routing systems are recommended for use by, and may be made mandatory for, all ships, certain categories of ships or ships carrying certain cargoes, when adopted and implemented in accordance with the guidelines and criteria developed by the Organization.†
- 2 The Organization is recognized as the only international body for developing guidelines, criteria and regulations on an international level for ships' routing systems. Contracting Governments shall refer proposals for the adoption of ships' routing systems to the Organization. The Organization will collate and disseminate to Contracting Governments all relevant information with regard to any adopted ships' routing systems.
- 3 The initiation of action for establishing a ships' routing system is the responsibility of the Government or Governments concerned. In developing such systems for adoption by the Organization, the guidelines and criteria developed by the Organization† shall be taken into account.
- 4 Ships' routing systems should be submitted to the Organization for adoption. However, a Government or Governments implementing ships' routing systems not intended to be submitted to the Organization for adoption or which have not been adopted by the Organization are encouraged to take into account, wherever possible, the guidelines and criteria developed by the Organization.†
- 5 Where two or more Governments have a common interest in a particular area, they should formulate joint proposals for the delineation and use of a routing system therein on the basis of an agreement between them. Upon receipt of such proposal and before proceeding with consideration of it for adoption, the Organization shall ensure that details of the proposal are disseminated to the Governments which have a common interest in the area, including countries in the vicinity of the proposed ships' routing system.

* Refer to the appropriate resolutions and recommendations adopted by the International Hydrographic Organization.

† Refer to *General provisions on ships' routing* (resolution A.572(14), as amended).

6 Contracting Governments shall adhere to the measures adopted by the Organization concerning ships' routing. They shall promulgate all information necessary for the safe and effective use of adopted ships' routing systems. A Government or Governments concerned may monitor traffic in those systems. Contracting Governments shall do everything in their power to secure the appropriate use of ships' routing systems adopted by the Organization.

7 A ship shall use a mandatory ships' routing system adopted by the Organization as required for its category or cargo carried and in accordance with the relevant provisions in force unless there are compelling reasons not to use a particular ships' routing system. Any such reason shall be recorded in the ships' log.

8 Mandatory ships' routing systems shall be reviewed by the Contracting Government or Governments concerned in accordance with the guidelines and criteria developed by the Organization.*

9 All adopted ships' routing systems and actions taken to enforce compliance with those systems shall be consistent with international law, including the relevant provisions of the 1982 United Nations Convention on the Law of the Sea.

10 Nothing in this regulation nor its associated guidelines and criteria shall prejudice the rights and duties of Governments under international law or the legal regimes of straits used for international navigation and archipelagic sea lanes.

Regulation 11

Ship reporting systems[†]

1 Ship reporting systems contribute to safety of life at sea, safety and efficiency of navigation and/or protection of the marine environment. A ship reporting system, when adopted and implemented in accordance with the guidelines and criteria developed by the Organization[‡] pursuant to this regulation, shall be used by all ships or certain categories of ships or ships carrying certain cargoes in accordance with the provisions of each system so adopted.

2 The Organization is recognized as the only international body for developing guidelines, criteria and regulations on an international level for ship reporting systems. Contracting Governments shall refer proposals for the adoption of ship reporting systems to the Organization. The Organization will collate and disseminate to Contracting Governments all relevant information with regard to any adopted ship reporting system.

3 The initiation of action for establishing a ship reporting system is the responsibility of the Government or Governments concerned. In developing such systems, provision of the guidelines and criteria developed by the Organization[‡] shall be taken into account.

4 Ship reporting systems not submitted to the Organization for adoption do not necessarily need to comply with this regulation. However, Governments implementing such systems are encouraged to follow, wherever possible, the guidelines and criteria developed by the Organization.[‡] Contracting Governments may submit such systems to the Organization for recognition.

5 Where two or more Governments have a common interest in a particular area, they should formulate proposals for a coordinated ship reporting system on the basis of agreement between them. Before proceeding with a proposal for adoption of a ship reporting system, the Organization shall disseminate details of the proposal to those Governments which have a common interest in the area covered by the proposed system. Where a coordinated ship reporting system is adopted and established, it shall have uniform procedures and operations.

* Refer to *General provisions on ships' routing* (resolution A.572(14), as amended).

† This regulation does not address ship reporting systems established by Governments for search and rescue purposes, which are covered by chapter 5 of the 1979 SAR Convention, as amended.

‡ Refer to revised *Guidelines and criteria for ship reporting systems* (MSC.433(98)) and *General principles for ship reporting systems and ship reporting requirements, including guidelines for reporting incidents involving dangerous goods, harmful substances and/or marine pollutants* (resolution A.851(20), as amended).

- 6 After adoption of a ship reporting system in accordance with this regulation, the Government or Governments concerned shall take all measures necessary for the promulgation of any information needed for the efficient and effective use of the system. Any adopted ship reporting system shall have the capability of interaction and the ability to assist ships with information when necessary. Such systems shall be operated in accordance with the guidelines and criteria developed by the Organization* pursuant to this regulation.
- 7 The master of a ship shall comply with the requirements of adopted ship reporting systems and report to the appropriate authority all information required in accordance with the provisions of each such system.
- 8 All adopted ship reporting systems and actions taken to enforce compliance with those systems shall be consistent with international law, including the relevant provisions of the United Nations Convention on the Law of the Sea.
- 9 Nothing in this regulation or its associated guidelines and criteria shall prejudice the rights and duties of Governments under international law or the legal regimes of straits used for international navigation and archipelagic sea lanes.
- 10 The participation of ships in accordance with the provisions of adopted ship reporting systems shall be free of charge to the ships concerned.
- 11 The Organization shall ensure that adopted ship reporting systems are reviewed under the guidelines and criteria developed by the Organization.

Regulation 12

Vessel traffic services

- 1 Vessel traffic services (VTS) contribute to safety of life at sea, safety and efficiency of navigation and protection of the marine environment, adjacent shore areas, work sites and offshore installations from possible adverse effects of maritime traffic.
- 2 Contracting Governments undertake to arrange for the establishment of VTS where, in their opinion, the volume of traffic or the degree of risk justifies such services.
- 3 Contracting Governments planning and implementing VTS shall, wherever possible, follow the guidelines developed by the Organization.† The use of VTS may only be made mandatory in sea areas within the territorial seas of a coastal State.
- 4 Contracting Governments shall endeavour to secure the participation in, and compliance with, the provisions of vessel traffic services by ships entitled to fly their flag.
- 5 Nothing in this regulation or the guidelines adopted by the Organization shall prejudice the rights and duties of Governments under international law or the legal regimes of straits used for international navigation and archipelagic sea lanes.

Regulation 13

Establishment and operation of aids to navigation

- 1 Each Contracting Government undertakes to provide, as it deems practical and necessary, either individually or in cooperation with other Contracting Governments, such aids to navigation as the volume of traffic justifies and the degree of risk requires.

* Refer to revised *Guidelines and criteria for ship reporting systems* (MSC.433(98)) and *General principles for ship reporting systems and ship reporting requirements, including guidelines for reporting incidents involving dangerous goods, harmful substances and/or marine pollutants* (resolution A.851(20), as amended).

† Refer to *Guidelines on vessel traffic services* (resolution A.857(20)).

2 In order to obtain the greatest possible uniformity in aids to navigation, Contracting Governments undertake to take into account the international recommendations and guidelines* when establishing such aids.

3 Contracting Governments undertake to arrange for information relating to aids to navigation to be made available to all concerned. Changes in the transmissions of position-fixing systems which could adversely affect the performance of receivers fitted in ships shall be avoided as far as possible and only be effected after timely and adequate notice has been promulgated.

Regulation 14

Ships' manning

1 Contracting Governments undertake, each for its national ships, to maintain, or, if it is necessary, to adopt, measures for the purpose of ensuring that, from the point of view of safety of life at sea, all ships shall be sufficiently and efficiently manned.†

2 For every ship to which chapter I applies, the Administration shall:

- .1 establish appropriate minimum safe manning following a transparent procedure, taking into account the relevant guidance adopted by the Organization;‡ and
- .2 issue an appropriate minimum safe manning document or equivalent as evidence of the minimum safe manning considered necessary to comply with the provisions of paragraph 1.

3 On all ships, to ensure effective crew performance in safety matters, a working language shall be established and recorded in the ship's logbook. The company, as defined in regulation IX/1, or the master, as appropriate, shall determine the appropriate working language. Each seafarer shall be required to understand and, where appropriate, give orders and instructions and to report back in that language. If the working language is not an official language of the State whose flag the ship is entitled to fly, all plans and lists required to be posted shall include a translation into the working language.

4 On ships to which chapter I applies, English shall be used on the bridge as the working language for bridge-to-bridge and bridge-to-shore safety communications as well as for communications on board between the pilot and bridge watchkeeping personnel,‡ unless those directly involved in the communication speak a common language other than English.

Regulation 15

Principles relating to bridge design, design and arrangement of navigational systems and equipment and bridge procedures

All decisions which are made for the purpose of applying the requirements of regulations 19, 22, 24, 25, 27 and 28 and which affect bridge design, the design and arrangement of navigational systems and equipment on the bridge and bridge procedures§ shall be taken with the aim of:

- .1 facilitating the tasks to be performed by the bridge team and the pilot in making full appraisal of the situation and in navigating the ship safely under all operational conditions;
- .2 promoting effective and safe bridge resource management;
- .3 enabling the bridge team and the pilot to have convenient and continuous access to essential information which is presented in a clear and unambiguous manner, using standardized symbols and coding systems for controls and displays;

* Refer to the appropriate recommendations and guidelines of IALA and to Maritime buoyage system (SN.1/Circ.297).

† Refer to *Principles of minimum safe manning* (resolution A.1047(27)).

‡ Refer to the *IMO Standard Marine Communication Phrases* (resolution A.918(22), as amended).

§ Refer to *Guidelines on ergonomic criteria for bridge equipment and layout* (MSC/Circ.982) and *Guidelines for bridge equipment and systems, their arrangement and integration* (BES) (SN.1/Circ.288) and, for INS, to revised *Recommendation on performance standards for an integrated navigational system* (resolution MSC.252(83), as amended).

- .4 indicating the operational status of automated functions and integrated components, systems and/or sub-systems;
- .5 allowing for expeditious, continuous and effective information processing and decision-making by the bridge team and the pilot;
- .6 preventing or minimizing excessive or unnecessary work and any conditions or distractions on the bridge which may cause fatigue or interfere with the vigilance of the bridge team and the pilot; and
- .7 minimizing the risk of human error and detecting such error, if it occurs, through monitoring and alarm systems, in time for the bridge team and the pilot to take appropriate action.

Regulation 16

Maintenance of equipment

- 1 The Administration shall be satisfied that adequate arrangements are in place to ensure that the performance of the equipment required by this chapter is maintained.
- 2 Except as provided in regulations I/7(b)(ii), I/8 and I/9, while all reasonable steps shall be taken to maintain the equipment required by this chapter in efficient working order, malfunctions of that equipment shall not be considered as making the ship unseaworthy or as a reason for delaying the ship in ports where repair facilities are not readily available, provided suitable arrangements are made by the master to take the inoperative equipment or unavailable information into account in planning and executing a safe voyage to a port where repairs can take place.

Regulation 17

Electromagnetic compatibility

- 1 Administrations shall ensure that all electrical and electronic equipment on the bridge or in the vicinity of the bridge, on ships constructed on or after 1 July 2002, is tested for electromagnetic compatibility, taking into account the recommendations developed by the Organization.*
- 2 Electrical and electronic equipment shall be so installed that electromagnetic interference does not affect the proper function of navigational systems and equipment.
- 3 Portable electrical and electronic equipment shall not be operated on the bridge if it may affect the proper function of navigational systems and equipment.

Regulation 18

Approval, surveys and performance standards of navigational systems and equipment and voyage data recorder

- 1 Systems and equipment required to meet the requirements of regulations 19 and 20 shall be of a type approved by the Administration.

* Refer to *General requirements for electromagnetic compatibility (EMC) for all electrical and electronic ship's equipment* (resolution A.813(19)).

2 Systems and equipment, including associated back-up arrangements, where applicable, installed on or after 1 July 2002 to perform the functional requirements of regulations 19 and 20 shall conform to appropriate performance standards not inferior to those adopted by the Organization.*

3 When systems and equipment are replaced or added to on ships constructed before 1 July 2002, such systems and equipment shall, in so far as is reasonable and practicable, comply with the requirements of paragraph 2.

4 Systems and equipment installed prior to the adoption of performance standards by the Organization may subsequently be exempted from full compliance with such standards at the discretion of the Administration, having due regard to the recommended criteria adopted by the Organization. However, for an electronic chart display and information system (ECDIS) to be accepted as satisfying the chart carriage requirement of regulation 19.2.1.4, that system shall conform to the relevant performance standards not inferior to those adopted by the Organization in effect on the date of installation, or, for systems installed before 1 January 1999, not inferior to the performance standards adopted by the Organization on 23 November 1995.†

* Refer to:

Recommendations on general requirements for shipborne radio equipment forming part of the global maritime distress and safety system (GMDSS) and for electronic navigational aids (resolution A.694(17));

Recommendation on performance standards for gyro-compasses (resolution A.424(XI));

Recommendation on performance standards for radar equipment (resolution MSC.64(67), annex 4);

Revised Recommendation on performance standards for radar equipment (resolution MSC.192(79));

Performance standards for automatic radar plotting aids (ARPAs) (resolution A.823(19));

Recommendation on performance standards for electronic chart display and information systems (ECDIS) (resolution A.817(19), as amended);

Recommendation on performance standards for shipborne Loran-C and Chayka receivers (resolution A.818(19));

Recommendation on performance standards for shipborne global positioning system (GPS) receiver equipment (resolution A.819(19), as amended);

Recommendation on performance standards for shipborne GLONASS receiver equipment (resolution MSC.53(66), as amended);

Recommendation on performance standards for shipborne DGPS and DGLONASS maritime radio beacon receiver equipment (resolution MSC.64(67), annex 2, as amended);

Recommendation on performance standards for shipborne combined GPS/GLONASS receiver equipment (resolution MSC.74(69), annex 1, as amended);

Performance standards for shipborne Galileo receiver equipment (resolution MSC.233(82));

Performance standards for shipborne Beidou Satellite Navigation System (BDS) receiver equipment (resolution MSC.379(93));

Performance standards for multi-system shipborne radionavigation receivers (resolution MSC.401(95), as amended);

Performance standards for shipborne Indian Regional Navigation Satellite System (IRNSS) receiver equipment (resolution MSC.449(99));

Recommendation on performance standards for heading control systems (resolution MSC.64(67), annex 3);

Recommendation on performance standards for track control systems (resolution MSC.74(69), annex 2);

Recommendation on performance standards for a universal shipborne automatic identification system (AIS) (resolution MSC.74 (69), annex 3);

Recommendation on performance standards for echo-sounding equipment (resolution A.224(VII), as amended);

Recommendation on performance standards for devices to indicate speed and distance (resolution A.824(19), as amended);

Performance standards for rate-of-turn indicators (resolution A.526(13));

Recommendation on performance standards for radar reflectors (resolution A.384(X), as amended);

Recommendation on performance standards for magnetic compasses (resolution A.382(X));

Recommendation on performance standards for daylight signalling lamps (resolution MSC.95(72));

Recommendation on performance standards for sound reception systems (resolution MSC.86(70), annex 1);

Recommendation on performance standards for shipborne voyage data recorders (VDRs) (resolution MSC.333(90));

Recommendation on performance standards for shipborne simplified voyage data recorders (S-VDRs) (resolution MSC.163(78), as amended);

Recommendations on performance standards for marine transmitting heading devices (THDs) (resolution MSC.116(73));

Performance standards for a bridge navigational watch alarm system (BNWAS) (resolution MSC.128(75)).

† Refer to *Recommendation on performance standards for shipborne simplified voyage data recorders (S-VDRs) (resolution MSC.163(78), as amended)*, *Revised performance standards for electronic chart display and information systems (ECDIS) (resolution MSC.232(82))*, *Recommendation on performance standards for electronic chart display and information systems (ECDIS) (resolution A.817(19), as amended)*, and *Revised performance standards and functional requirements for the long-range identification and tracking of ships (resolution MSC.263(84), as amended)*.

5 The Administration shall require that the manufacturers have a quality control system audited by a competent authority to ensure continuous compliance with the type approval conditions. Alternatively, the Administration may use final product verification procedures where the compliance with the type approval certificate is verified by a competent authority before the product is installed on board ships.

6 Before giving approval to systems or equipment embodying new features not covered by this chapter, the Administration shall ensure that such features support functions at least as effective as those required by this chapter.

7 When equipment, for which performance standards have been developed by the Organization, is carried on ships in addition to those items of equipment required by regulations 19 and 20, such equipment shall be subject to approval and shall, as far as practicable, comply with performance standards not inferior to those adopted by the Organization.

8 The voyage data recorder system, including all sensors, shall be subjected to an annual performance test. The test shall be conducted by an approved testing or servicing facility to verify the accuracy, duration and recoverability of the recorded data. In addition, tests and inspections shall be conducted to determine the serviceability of all protective enclosures and devices fitted to aid location. A copy of the certificate of compliance issued by the testing facility, stating the date of compliance and the applicable performance standards, shall be retained on board the ship.

SEE INTERPRETATION 1

9 The automatic identification system (AIS) shall be subjected to an annual test. The test shall be conducted by an approved surveyor or an approved testing or servicing facility. The test shall verify the correct programming of the ship static information, correct data exchange with connected sensors as well as verifying the radio performance by radio frequency measurement and on-air test using, e.g. a Vessel Traffic Service (VTS). A copy of the test report shall be retained on board the ship.

SEE INTERPRETATION 2

Regulation 19

Carriage requirements for shipborne navigational systems and equipment

1 Application and requirements

Subject to the provisions of regulation 1.4:

1.1 Ships constructed on or after 1 July 2002 shall be fitted with navigational systems and equipment which will fulfil the requirements prescribed in paragraphs 2.1 to 2.9.

1.2 Ships constructed before 1 July 2002 shall:

- .1 subject to the provisions of paragraphs 1.2.2, 1.2.3 and 1.2.4, unless they comply fully with this regulation, continue to be fitted with equipment which fulfils the requirements prescribed in regulations V/11, V/12 and V/20 of the International Convention for the Safety of Life at Sea, 1974 in force prior to 1 July 2002;
- .2 be fitted with the equipment or systems required in paragraph 2.1.6 not later than the first survey* after 1 July 2002, at which time the radio direction-finding apparatus referred to in V/12(p) of the *International Convention for the Safety of Life at Sea, 1974* in force prior to 1 July 2002 shall no longer be required;
- .3 be fitted with the system required in paragraph 2.4 not later than the dates specified in paragraphs 2.4.2 and 2.4.3;

* Refer to *Unified interpretation of the term "first survey" referred to in SOLAS regulations* (MSC.1/Circ.1290).

- .4 be fitted with the system required in paragraph 2.2.3, as follows:
 - .1 passenger ships irrespective of size, not later than the first survey* after 1 January 2016;
 - .2 cargo ships of 3,000 gross tonnage and upwards, not later than the first survey* after 1 January 2016;
 - .3 cargo ships of 500 gross tonnage and upwards but less than 3,000 gross tonnage, not later than the first survey* after 1 January 2017; and
 - .4 cargo ships of 150 gross tonnage and upwards but less than 500 gross tonnage, not later than the first survey* after 1 January 2018.

The bridge navigational watch alarm system shall be in operation whenever the ship is underway at sea.

The provisions of paragraph 2.2.4 shall also apply to ships constructed before 1 July 2002.

1.3 Administrations may exempt ships from the application of the requirement of paragraph 1.2.4 when such ships will be taken permanently out of service within two years after the implementation date specified in subparagraphs 1.2.4.1 to 1.2.4.4.

2 Shipborne navigational equipment and systems

2.1 All ships, irrespective of size, shall have:

- .1 a properly adjusted standard magnetic compass, or other means, independent of any power supply, to determine the ship's heading and display the reading at the main steering position;
- .2 a pelorus or compass bearing device, or other means, independent of any power supply, to take bearings over an arc of the horizon of 360°;
- .3 means of correcting heading and bearings to true at all times;
- .4 nautical charts and nautical publications to plan and display the ship's route for the intended voyage and to plot and monitor positions throughout the voyage. An electronic chart display and information system (ECDIS) is also accepted as meeting the chart carriage requirements of this subparagraph. Ships to which paragraph 2.10 applies shall comply with the carriage requirements for ECDIS detailed therein;
- .5 back-up arrangements to meet the functional requirements of subparagraph .4, if this function is partly or fully fulfilled by electronic means*;
- .6 a receiver for a global navigation satellite system or a terrestrial radionavigation system, or other means, suitable for use at all times throughout the intended voyage to establish and update the ship's position by automatic means;
- .7 if less than 150 gross tonnage and if practicable, a radar reflector, or other means, to enable detection by ships navigating by radar at both 9 and 3 GHz;
- .8 when the ship's bridge is totally enclosed and unless the Administration determines otherwise, a sound reception system, or other means, to enable the officer in charge of the navigational watch to hear sound signals and determine their direction; and
- .9 a telephone, or other means, to communicate heading information to the emergency steering position, if provided.

* Refer to appendix 6, Back-up requirements, of *Performance standards for electronic chart display and information systems (ECDIS)* (resolution A.817(19), as amended). An appropriate folio of paper nautical charts may be used as a back-up arrangement for ECDIS. Other back-up arrangements for ECDIS are acceptable.

2.2 All ships of 150 gross tonnage and upwards and passenger ships irrespective of size shall, in addition to the requirements of paragraph 2.1, be fitted with:

- .1 a spare magnetic compass, interchangeable with the magnetic compass as referred to in paragraph 2.1.1, or other means to perform the function referred to in paragraph 2.1.1 by means of replacement or duplicate equipment;
- .2 a daylight signalling lamp, or other means, to communicate by light during day and night using an energy source of electrical power not solely dependent upon the ship's power supply;
- .3 a bridge navigational watch alarm system (BNWAS), as follows:
 - .1 cargo ships of 150 gross tonnage and upwards and passenger ships irrespective of size constructed on or after 1 July 2011;
 - .2 passenger ships irrespective of size constructed before 1 July 2011, not later than the first survey* after 1 July 2012;
 - .3 cargo ships of 3,000 gross tonnage and upwards constructed before 1 July 2011, not later than the first survey* after 1 July 2012;
 - .4 cargo ships of 500 gross tonnage and upwards but less than 3,000 gross tonnage constructed before 1 July 2011, not later than the first survey* after 1 July 2013; and
 - .5 cargo ships of 150 gross tonnage and upwards but less than 500 gross tonnage constructed before 1 July 2011, not later than the first survey* after 1 July 2014.

The bridge navigational watch alarm system shall be in operation whenever the ship is underway at sea;

- .4 a bridge navigational watch alarm system (BNWAS) installed prior to 1 July 2011 may subsequently be exempted from full compliance with the standards adopted by the Organization, at the discretion of the Administration.

2.3 All ships of 300 gross tonnage and upwards and passenger ships irrespective of size shall, in addition to meeting the requirements of paragraph 2.2, be fitted with:

- .1 an echo-sounding device, or other electronic means, to measure and display the available depth of water;
- .2 a 9 GHz radar, or other means, to determine and display the range and bearing of radar transponders and of other surface craft, obstructions, buoys, shorelines and navigational marks to assist in navigation and in collision avoidance;
- .3 an electronic plotting aid, or other means, to plot electronically the range and bearing of targets to determine collision risk;
- .4 speed and distance measuring device, or other means, to indicate speed and distance through the water;

SEE INTERPRETATION 3

- .5 a properly adjusted transmitting heading device, or other means, to transmit heading information for input to the equipment referred to in paragraphs 2.3.2, 2.3.3 and 2.4.

2.4 All ships of 300 gross tonnage and upwards engaged on international voyages and cargo ships of 500 gross tonnage and upwards not engaged on international voyages and passenger ships irrespective of size shall be fitted with an automatic identification system (AIS), as follows:

- .1 ships constructed on or after 1 July 2002;
- .2 ships engaged on international voyages constructed before 1 July 2002:
 - .1 in the case of passenger ships, not later than 1 July 2003;

* Refer to *Unified interpretation of the term "first survey" referred to in SOLAS regulations (MSC.1/Circ.1290)*.

- .2 in the case of tankers, not later than the first survey* for safety equipment† on or after 1 July 2003;
 - .3 in the case of ships, other than passenger ships and tankers, of 50,000 gross tonnage and upwards, not later than 1 July 2004;
 - .4 in the case of ships, other than passenger ships and tankers, of 300 gross tonnage and upwards but less than 50,000 gross tonnage, not later than the first safety equipment survey‡ after 1 July 2004 or by 31 December 2004, whichever occurs earlier; and
- .3 ships not engaged on international voyages constructed before 1 July 2002, not later than 1 July 2008;
 - .4 the Administration may exempt ships from the application of the requirements of this paragraph when such ships will be taken permanently out of service within two years after the implementation date specified in subparagraphs .2 and .3;
 - .5 AIS shall:
 - .1 provide automatically to appropriately equipped shore stations, other ships and aircraft information, including the ship's identity, type, position, course, speed, navigational status and other safety-related information;
 - .2 receive automatically such information from similarly fitted ships;
 - .3 monitor and track ships; and
 - .4 exchange data with shore-based facilities;
 - .6 the requirements of paragraph 2.4.5 shall not be applied to cases where international agreements, rules or standards provide for the protection of navigational information; and
 - .7 AIS shall be operated taking into account the guidelines adopted by the Organization.§ Ships fitted with AIS shall maintain AIS in operation at all times except where international agreements, rules or standards provide for the protection of navigational information.

2.5 All ships of 500 gross tonnage and upwards shall, in addition to meeting the requirements of paragraph 2.3, with the exception of paragraphs 2.3.3 and 2.3.5, and the requirements of paragraph 2.4, have:

- .1 a gyro-compass, or other means, to determine and display their heading by shipborne non-magnetic means, being clearly readable by the helmsman at the main steering position. These means shall also transmit heading information for input to the equipment referred to in paragraphs 2.3.2, 2.4 and 2.5.5;
- .2 a gyro-compass heading repeater, or other means, to supply heading information visually at the emergency steering position if provided;
- .3 a gyro-compass bearing repeater, or other means, to take bearings, over an arc of the horizon of 360°, using the gyro-compass or other means referred to in subparagraph .1. However, ships of less than 1,600 gross tonnage shall be fitted with such means as far as possible;
- .4 rudder, propeller, thrust, pitch and operational mode indicators, or other means, to determine and display rudder angle, propeller revolutions, the force and direction of thrust and, if applicable, the force and direction of lateral thrust and the pitch and operational mode, all to be readable from the conning position; and
- .5 an automatic tracking aid, or other means, to plot automatically the range and bearing of other targets to determine collision risk.

* Refer to *Unified interpretation of the term "first survey" referred to in SOLAS regulations (MSC.1/Circ.1290)*.

† Refer to regulation I/8.

‡ The first safety equipment survey means the first annual survey, the first periodical survey or the first renewal survey for safety equipment, whichever is due first after 1 July 2004, and, in addition, in the case of ships under construction, the initial survey.

§ Refer to *Revised guidelines for the onboard operational use of shipborne Automatic Identification Systems (AIS) (resolution A.1106(29))*.

2.6 On all ships of 500 gross tonnage and upwards, failure of one piece of equipment should not reduce the ship's ability to meet the requirements of paragraphs 2.1.1, 2.1.2 and 2.1.4.

2.7 All ships of 3,000 gross tonnage and upwards shall, in addition to meeting the requirements of paragraph 2.5, have:

- .1** a 3 GHz radar or, where considered appropriate by the Administration, a second 9 GHz radar, or other means, to determine and display the range and bearing of other surface craft, obstructions, buoys, shorelines and navigational marks to assist in navigation and in collision avoidance, which are functionally independent of those referred to in paragraph 2.3.2; and
- .2** a second automatic tracking aid, or other means, to plot automatically the range and bearing of other targets to determine collision risk which are functionally independent of those referred to in paragraph 2.5.5.

2.8 All ships of 10,000 gross tonnage and upwards shall, in addition to meeting the requirements of paragraph 2.7 with the exception of paragraph 2.7.2, have:

- .1** an automatic radar plotting aid, or other means, to plot automatically the range and bearing of at least 20 other targets, connected to a device to indicate speed and distance through the water, to determine collision risks and simulate a trial manoeuvre; and
- .2** a heading or track control system, or other means, to automatically control and keep to a heading and/or straight track.

2.9 All ships of 50,000 gross tonnage and upwards shall, in addition to meeting the requirements of paragraph 2.8, have:

- .1** a rate-of-turn indicator, or other means, to determine and display the rate of turn; and
- .2** a speed and distance measuring device, or other means, to indicate speed and distance over the ground in the forward and athwartships direction.

SEE INTERPRETATION 3

2.10 Ships engaged on international voyages shall be fitted with an electronic chart display and information system (ECDIS) as follows:

- .1** passenger ships of 500 gross tonnage and upwards constructed on or after 1 July 2012;
- .2** tankers of 3,000 gross tonnage and upwards constructed on or after 1 July 2012;
- .3** cargo ships, other than tankers, of 10,000 gross tonnage and upwards constructed on or after 1 July 2013;
- .4** cargo ships, other than tankers, of 3,000 gross tonnage and upwards but less than 10,000 gross tonnage constructed on or after 1 July 2014;
- .5** passenger ships of 500 gross tonnage and upwards constructed before 1 July 2012, not later than the first survey* on or after 1 July 2014;
- .6** tankers of 3,000 gross tonnage and upwards constructed before 1 July 2012, not later than the first survey* on or after 1 July 2015;
- .7** cargo ships, other than tankers, of 50,000 gross tonnage and upwards constructed before 1 July 2013, not later than the first survey* on or after 1 July 2016;
- .8** cargo ships, other than tankers, of 20,000 gross tonnage and upwards but less than 50,000 gross tonnage constructed before 1 July 2013, not later than the first survey* on or after 1 July 2017; and

* Refer to *Unified interpretation of the term "first survey" referred to in SOLAS regulations (MSC.1/Circ.1290)*.

- .9 cargo ships, other than tankers, of 10,000 gross tonnage and upwards but less than 20,000 gross tonnage constructed before 1 July 2013, not later than the first survey* on or after 1 July 2018.

2.11 Administrations may exempt ships from the application of the requirements of paragraph 2.10 when such ships will be taken permanently out of service within two years after the implementation date specified in subparagraphs .5 to .9 of paragraph 2.10.

3 When "other means" are permitted under this regulation, such means must be approved by the Administration in accordance with regulation 18.

4 The navigational equipment and systems referred to in this regulation shall be so installed, tested and maintained as to minimize malfunction.

5 Navigational equipment and systems offering alternative modes of operation shall indicate the actual mode of use.

6 Integrated bridge systems[†] shall be so arranged that failure of one sub-system is brought to the immediate attention of the officer in charge of the navigational watch by audible and visual alarms and does not cause failure to any other sub-system. In case of failure in one part of an integrated navigational system,[‡] it shall be possible to operate each other individual item of equipment or part of the system separately.

Regulation 19-1

Long-range identification and tracking of ships[§]

1 Nothing in this regulation or the provisions of performance standards and functional requirements[¶] adopted by the Organization in relation to the long-range identification and tracking of ships shall prejudice the rights, jurisdiction or obligations of States under international law, in particular, the legal regimes of the high seas, the exclusive economic zone, the contiguous zone, the territorial seas or the straits used for international navigation and archipelagic sea lanes.

2.1 Subject to the provisions of paragraphs 4.1 and 4.2, this regulation shall apply to the following types of ships^{**} engaged on international voyages:

- .1 passenger ships, including high-speed passenger craft;
- .2 cargo ships, including high-speed craft, of 300 gross tonnage^{††} and upwards; and
- .3 mobile offshore drilling units.

2.2 The term *ship*, when used in paragraphs 3 to 11.2, includes the passenger and cargo ships, the high-speed craft and the mobile offshore drilling units which are subject to the provisions of this regulation.

3 This regulation establishes provisions to enable Contracting Governments to undertake the long-range identification and tracking of ships.

* Refer to *Unified interpretation of the term "first survey" referred to in SOLAS regulations* (MSC.1/Circ.1290).

† Refer to *Guidelines for bridge equipment and systems, their arrangement and integration* (BES) (SN.1/Circ.288).

‡ Refer to revised *Recommendation on performance standards for an integrated navigational system* (resolution MSC.252(83), as amended).

§ Refer to *Guidance on the implementation of the LRIT system* (MSC.1/Circ.1298).

¶ Refer to *Revised performance standards and functional requirements for the long-range identification and tracking of ships* (resolution MSC.263(84), as amended).

** Refer to *Guidance in relation to certain types of ships which are required to transmit LRIT information on exemptions and equivalents and on certain operational matters* (MSC.1/Circ.1295).

†† The *gross tonnage* to be used for determining whether a cargo ship or high-speed craft is required to comply with the provisions of this regulation shall be that determined under the provisions of the international Convention on Tonnage Measurement of Ships, 1969 irrespective of the date on which the ship or high-speed craft has been or is being constructed.

4.1 Ships* shall be fitted with a system to automatically transmit the information specified in paragraph 5 as follows:

- .1 ships constructed on or after 31 December 2008;
- .2 ships constructed before 31 December 2008 and certified for operations:
 - .1 in sea areas A1 and A2, as defined in regulations IV/2.1.12 and IV/2.1.13; or
 - .2 in sea areas A1, A2 and A3, as defined in regulations IV/2.1.12, IV/2.1.13 and IV/2.1.14;

not later than the first survey[†] of the radio installation after 31 December 2008;

- .3 ships constructed before 31 December 2008 and certified for operations in sea areas A1, A2, A3 and A4, as defined in regulations IV/2.1.12, IV/2.1.13, IV/2.1.14 and IV/2.1.15, not later than the first survey[†] of the radio installation after 1 July 2009. However, these ships shall comply with the provisions of subparagraph .2 above whilst they operate within sea areas A1, A2 and A3.

4.2 Ships, irrespective of the date of construction, fitted with an automatic identification system (AIS), as defined in regulation 19.2.4, and operated exclusively within sea area A1, as defined in regulation IV/2.1.12, shall not be required to comply with the provisions of this regulation.

5 Subject to the provisions of paragraph 4.1, ships shall automatically transmit the following long-range identification and tracking information:

- .1 the identity of the ship;
- .2 the position of the ship (latitude and longitude); and
- .3 the date and time of the position provided.

6 Systems and equipment used to meet the requirements of this regulation shall conform to performance standards and functional requirements^{‡,§} not inferior to those adopted by the Organization. Any shipboard equipment shall be of a type approved* by the Administration.

7 Systems and equipment used to meet the requirements of this regulation shall be capable of being switched off on board or be capable of ceasing the distribution of long-range identification and tracking information:

- .1 where international agreements, rules or standards provide for the protection of navigational information; or
- .2 in exceptional circumstances and for the shortest duration possible where the operation is considered by the master to compromise the safety or security of the ship. In such a case, the master shall inform the Administration without undue delay and make an entry in the record of navigational activities and incidents maintained in accordance with regulation 28 setting out the reasons for the decision and indicating the period during which the system or equipment was switched off.

8.1 Subject to the provisions of paragraphs 8.2 to 11.2, Contracting Governments shall be able to receive long-range identification and tracking information about ships, for security and other purposes[¶] as agreed by the Organization, as follows:

- .1 the Administration shall be entitled to receive such information about ships entitled to fly its flag irrespective of where such ships may be located;
- .2 a Contracting Government shall be entitled to receive such information about ships which have indicated their intention to enter a port facility, as defined in regulation XI-2/1.1.9, or a place

* Refer to *Guidance on the survey and certification of compliance of ships with the requirement to transmit LRIT information* (MSC.1/Circ.1307).

† Refer to *Unified interpretation of the term "first survey" referred to in SOLAS regulations* (MSC.1/Circ.1290).

‡ Refer to *Revised performance standards and functional requirements for the long-range identification and tracking of ships* (resolution MSC.263(84), as amended).

§ Refer to *LRIT technical documentation (part I)* (MSC.1/Circ.1259, as revised).

¶ Refer to *Use of the long-range identification and tracking information for maritime safety and marine environment protection purposes* (resolution MSC.242(83)).

under the jurisdiction of that Contracting Government, irrespective of where such ships may be located provided they are not located within the waters landward of the baselines, established in accordance with international law, of another Contracting Government;

- .3 a Contracting Government shall be entitled to receive such information about ships entitled to fly the flag of other Contracting Governments, not intending to enter a port facility or a place under the jurisdiction of that Contracting Government, navigating within a distance not exceeding 1,000 nautical miles of its coast provided such ships are not located within the waters landward of the baselines, established in accordance with international law, of another Contracting Government; and
- .4 a Contracting Government shall not be entitled to receive, pursuant to subparagraph .3, such information about a ship located within the territorial sea of the Contracting Government whose flag the ship is entitled to fly.

8.2 Contracting Governments shall specify and communicate* to the Organization relevant details, taking into account the performance standards and functional requirements adopted by the Organization,† to enable long-range identification and tracking information to be made available pursuant to the provisions of paragraph 8.1. The Contracting Government concerned may, at any time thereafter, amend or withdraw such communication. The Organization shall inform all Contracting Governments upon receipt of such communication together with the particulars thereof.

9.1 Notwithstanding the provisions of paragraph 8.1.3, the Administration shall be entitled, in order to meet security or other concerns, at any time, to decide that long-range identification and tracking information about ships entitled to fly its flag shall not be provided pursuant to the provisions of paragraph 8.1.3 to Contracting Governments. The Administration concerned may, at any time thereafter, amend, suspend or annul such decisions.

9.2 The Administration concerned shall communicate, pursuant to paragraph 9.1, such decisions to the Organization. The Organization shall inform all Contracting Governments upon receipt of such communication together with the particulars thereof.

9.3 The rights, duties and obligations, under international law, of the ships whose Administration invoked the provisions of paragraph 9.1 shall not be prejudiced as a result of such decisions.

10 Contracting Governments shall, at all times:

- .1 recognize the importance of long-range identification and tracking information;
- .2 recognize and respect the commercial confidentiality and sensitivity of any long-range identification and tracking information they may receive;
- .3 protect the information they may receive from unauthorized access or disclosure; and
- .4 use the information they may receive in a manner consistent with international law.

11.1 Contracting Governments shall bear all costs associated with any long-range identification and tracking information they request and receive. Notwithstanding the provisions of paragraph 11.2, Contracting Governments shall not impose any charges on ships in relation to the long-range identification and tracking information they may seek to receive.

11.2 Unless the national legislation of the Administration provides otherwise, ships entitled to fly its flag shall not incur any charges for transmitting long-range identification and tracking information in compliance with the provisions of this regulation.

12 Notwithstanding the provisions of paragraph 8.1, the search and rescue services‡ of Contracting Governments shall be entitled to receive, free of any charges, long-range identification and tracking information in relation to the search and rescue of persons in distress at sea.

* Refer to *Guidance on the implementation of the LRIT system* (MSC.1/Circ.1298).

† Refer to *Revised performance standards and functional requirements for the long-range identification and tracking of ships* (resolution MSC.263(84), as amended).

‡ Refer to *Guidance to search and rescue services in relation to requesting and receiving LRIT information* (MSC.1/Circ.1338, as revised).

13 Contracting Governments may report to the Organization any case where they consider that provisions of this regulation or of any other related requirements established by the Organization have not been or are not being observed or adhered to.

14 The Maritime Safety Committee shall determine the criteria, procedures and arrangements for the establishment, review and audit* of the provision of long-range identification and tracking information to Contracting Governments pursuant to the provisions of this regulation.

Regulation 20

Voyage data recorders†

1 To assist in casualty investigations, ships, when engaged on international voyages, subject to the provisions of regulation 1.4, shall be fitted with a voyage data recorder (VDR) as follows:

- .1 passenger ships constructed on or after 1 July 2002;
- .2 ro-ro passenger ships constructed before 1 July 2002, not later than the first survey‡ on or after 1 July 2002;
- .3 passenger ships, other than ro-ro passenger ships, constructed before 1 July 2002, not later than 1 January 2004; and
- .4 ships, other than passenger ships, of 3,000 gross tonnage and upwards constructed on or after 1 July 2002.

2 To assist in casualty investigations, cargo ships, when engaged on international voyages, shall be fitted with a VDR which may be a simplified voyage data recorder (S-VDR)§ as follows:

- .1 in the case of cargo ships of 20,000 gross tonnage and upwards constructed before 1 July 2002, at the first scheduled dry-docking after 1 July 2006 but not later than 1 July 2009;
- .2 in the case of cargo ships of 3,000 gross tonnage and upwards but less than 20,000 gross tonnage constructed before 1 July 2002, at the first scheduled dry-docking after 1 July 2007 but not later than 1 July 2010; and
- .3 Administrations may exempt cargo ships from the application of the requirements of subparagraphs .1 and .2 when such ships will be taken permanently out of service within two years after the implementation date specified in subparagraphs .1 and .2 above.

3 Administrations may exempt ships, other than ro-ro passenger ships, constructed before 1 July 2002 from being fitted with a VDR where it can be demonstrated that interfacing a VDR with the existing equipment on the ship is unreasonable and impracticable.

Regulation 21

International Code of Signals and IAMSAR Manual

1 All ships which, in accordance with the present Convention, are required to carry a radio installation shall carry the International Code of Signals as may be amended by the Organization. The Code shall also be carried by any other ship which, in the opinion of the Administration, has a need to use it.

* Refer to *Appointment of the LRIT Coordinator* (resolution MSC.275(85)), *Revised performance standards and functional requirements for the long-range identification and tracking of ships* (resolution MSC.263(84), as amended) and *Principles and guidelines relating to the review and audit of the performance of LRIT Data Centres and the International LRIT Data Exchange* (MSC.1/Circ.1412, as revised).

† Refer to *Performance Standards for Shipborne Voyage Data Recorders (VDRs)* (resolution A.861(20), as amended), *Recommendation on Performance Standards for Shipborne Voyage Data Recorders (VDRs)* (resolution MSC.333(90)) and *Guidelines on voyage data recorder (VDR) ownership and recovery* (MSC/Circ.1024).

‡ Refer to *Unified interpretation of the term "first survey" referred to in SOLAS regulations* (MSC.1/Circ.1290).

§ Refer to *Performance standards for shipborne simplified voyage data recorders (S-VDRs)* (resolution MSC.163(78), as amended).

2 All ships shall carry an up-to-date copy of Volume III of the International Aeronautical and Maritime Search and Rescue (IAMSAR) Manual.

Regulation 22

Navigation bridge visibility

SEE INTERPRETATION 4

1 Ships of not less than 55 m in length, as defined in regulation 2.4, constructed on or after 1 July 1998, shall meet the following requirements:

- .1 The view of the sea surface from the conning position shall not be obscured by more than two ship lengths, or 500 m, whichever is less, forward of the bow to 10° on either side under all conditions of draught, trim and deck cargo;
- .2 No blind sector, caused by cargo, cargo gear or other obstructions outside of the wheelhouse forward of the beam which obstructs the view of the sea surface as seen from the conning position, shall exceed 10°. The total arc of blind sectors shall not exceed 20°. The clear sectors between blind sectors shall be at least 5°. However, in the view described in .1, each individual blind sector shall not exceed 5°;
- .3 The horizontal field of vision from the conning position shall extend over an arc of not less than 225°, that is from right ahead to not less than 22.5° abaft the beam on either side of the ship;
- .4 From each bridge wing, the horizontal field of vision shall extend over an arc of at least 225°, that is from at least 45° on the opposite bow through right ahead and then from right ahead to right astern through 180° on the same side of the ship;
- .5 From the main steering position, the horizontal field of vision shall extend over an arc from right ahead to at least 60° on each side of the ship;
- .6 The ship's side shall be visible from the bridge wing;

SEE INTERPRETATION 5

- .7 The height of the lower edge of the navigation bridge front windows above the bridge deck shall be kept as low as possible. In no case shall the lower edge present an obstruction to the forward view as described in this regulation;
- .8 The upper edge of the navigation bridge front windows shall allow a forward view of the horizon, for a person with a height of eye of 1,800 mm above the bridge deck at the conning position, when the ship is pitching in heavy seas. The Administration, if satisfied that a 1,800 mm height of eye is unreasonable and impractical, may allow reduction of the height of eye but not to less than 1,600 mm;
- .9 Windows shall meet the following requirements:
 - .1 To help avoid reflections, the bridge front windows shall be inclined from the vertical plane top out, at an angle of not less than 10° and not more than 25°;
 - .2 Framing between navigation bridge windows shall be kept to a minimum and not be installed immediately forward of any work station;
 - .3 Polarized and tinted windows shall not be fitted;
 - .4 A clear view through at least two of the navigation bridge front windows and, depending on the bridge configuration, an additional number of clear-view windows shall be provided at all times, regardless of weather conditions.

2 Ships constructed before 1 July 1998 shall, where practicable, meet the requirements of paragraphs 1.1 and 1.2. However, structural alterations or additional equipment need not be required.

3 On ships of unconventional design which, in the opinion of the Administration, cannot comply with this regulation, arrangements shall be provided to achieve a level of visibility that is as near as practical to that prescribed in this regulation.

4 Notwithstanding the requirements of paragraphs 1.1, 1.3, 1.4 and 1.5, ballast water exchange may be undertaken provided that:

- .1 the master has determined that it is safe to do so and takes into consideration any increased blind sectors or reduced horizontal fields of vision resulting from the operation to ensure that a proper lookout is maintained at all times;
- .2 the operation is conducted in accordance with the ship's ballast water management plan, taking into account the recommendations on ballast water exchange adopted by the Organization; and
- .3 the commencement and termination of the operation are recorded in the ship's record of navigational activities pursuant to regulation 28.

Regulation 23

Pilot transfer arrangements

SEE INTERPRETATION 6

1 Application

1.1 Ships engaged on voyages in the course of which pilots may be employed shall be provided with pilot transfer arrangements.

1.2 Equipment and arrangements for pilot transfer which are installed* on or after 1 July 2012 shall comply with the requirements of this regulation, and due regard shall be paid to the standards adopted by the Organization.†

1.3 Except as provided otherwise, equipment and arrangements for pilot transfer which are provided on ships before 1 July 2012 shall at least comply with the requirements of regulation 17‡ or 23, as applicable, of the Convention in force prior to that date, and due regard shall be paid to the standards adopted by the Organization prior to that date.

1.4 Equipment and arrangements installed on or after 1 July 2012, which are a replacement of equipment and arrangements provided on ships before 1 July 2012, shall, in so far as is reasonable and practicable, comply with the requirements of this regulation.

1.5 With respect to ships constructed before 1 January 1994, paragraph 5 shall apply not later than the first survey§ on or after 1 July 2012.

1.6 Paragraph 6 applies to all ships.

2 General

2.1 All arrangements used for pilot transfer shall efficiently fulfil their purpose of enabling pilots to embark and disembark safely. The appliances shall be kept clean, properly maintained and stowed and shall be regularly inspected to ensure that they are safe to use. They shall be used solely for the embarkation and disembarkation of personnel.

2.2 The rigging of the pilot transfer arrangements and the embarkation of a pilot shall be supervised by a responsible officer having means of communication with the navigation bridge and who shall also arrange

* Refer to *Unified interpretation of SOLAS regulation V/23* (MSC.1/Circ.1375).

† Refer to *Pilot transfer arrangements* (resolution A.1045(27), as amended).

‡ Refer to resolution MSC.99(73), renumbering previous regulation 17 as regulation 23, which entered into force on 1 July 2002.

§ Refer to *Unified interpretation of the term "first survey" referred to in SOLAS regulations* (MSC.1/Circ.1290).

for the escort of the pilot by a safe route to and from the navigation bridge. Personnel engaged in rigging and operating any mechanical equipment shall be instructed in the safe procedures to be adopted and the equipment shall be tested prior to use.

2.3 A pilot ladder shall be certified by the manufacturer as complying with this regulation or with an international standard acceptable to the Organization.* Ladders shall be inspected in accordance with regulations I/6, 7 and 8.

2.4 All pilot ladders used for pilot transfer shall be clearly identified with tags or other permanent marking so as to enable identification of each appliance for the purposes of survey, inspection and record keeping. A record shall be kept on the ship as to the date the identified ladder is placed into service and any repairs effected.

2.5 Reference in this regulation to an accommodation ladder includes a sloping ladder used as part of the pilot transfer arrangements.

3 Transfer arrangements

3.1 Arrangements shall be provided to enable the pilot to embark and disembark safely on either side of the ship.

3.2 In all ships, where the distance from sea level to the point of access to, or egress from, the ship exceeds 9 m, and when it is intended to embark and disembark pilots by means of the accommodation ladder,† or other equally safe and convenient means in conjunction with a pilot ladder, the ship shall carry such equipment on each side, unless the equipment is capable of being transferred for use on either side.

3.3 Safe and convenient access to, and egress from, the ship shall be provided by either:

- .1** a pilot ladder requiring a climb of not less than 1.5 m and not more than 9 m above the surface of the water so positioned and secured that:
 - .1** it is clear of any possible discharges from the ship;
 - .2** it is within the parallel body length of the ship and, as far as is practicable, within the mid-ship half length of the ship;
 - .3** each step rests firmly against the ship's side; where constructional features, such as rubbing bands, would prevent the implementation of this provision, special arrangements shall, to the satisfaction of the Administration, be made to ensure that persons are able to embark and disembark safely;
 - .4** the single length of pilot ladder is capable of reaching the water from the point of access to, or egress from, the ship and due allowance is made for all conditions of loading and trim of the ship, and for an adverse list of 15°; the securing strong point, shackles and securing ropes shall be at least as strong as the side ropes; or
- .2** an accommodation ladder in conjunction with the pilot ladder (i.e. a combination arrangement), or other equally safe and convenient means, whenever the distance from the surface of the water to the point of access to the ship is more than 9 m. The accommodation ladder shall be sited leading aft. When in use, means shall be provided to secure the lower platform of the accommodation ladder to the ship's side, so as to ensure that the lower end of the accommodation ladder and the lower platform are held firmly against the ship's side within the parallel body length of the ship and, as far as is practicable, within the mid-ship half length and clear of all discharges;
 - .1** when a combination arrangement is used for pilot access, means shall be provided to secure the pilot ladder and manropes to the ship's side at a point of nominally 1.5 m above the bottom platform of the accommodation ladder. In the case of a combination arrangement

* Refer to the recommendations by the International Organization for Standardization, in particular publication ISO 799-1:2019, *Ships and marine technology – Pilot ladders*.

† Refer to regulation II-1/3-9 on *Means of embarkation on and disembarkation from ships*.

using an accommodation ladder with a trapdoor in the bottom platform (i.e. embarkation platform), the pilot ladder and manropes shall be rigged through the trapdoor extending above the platform to the height of the handrail.

SEE INTERPRETATION 7

4 Access to the ship's deck

Means shall be provided to ensure safe, convenient and unobstructed passage for any person embarking on, or disembarking from, the ship between the head of the pilot ladder, or of any accommodation ladder or other appliance, and the ship's deck. Where such passage is by means of:

- .1 a gateway in the rails or bulwark, adequate handholds shall be provided;
- .2 a bulwark ladder, two handhold stanchions rigidly secured to the ship's structure at or near their bases and at higher points shall be fitted. The bulwark ladder shall be securely attached to the ship to prevent overturning.

5 Shipline doors

Shipline doors used for pilot transfer shall not open outwards.

6 Mechanical pilot hoists

Mechanical pilot hoists shall not be used.

7 Associated equipment

7.1 The following associated equipment shall be kept at hand ready for immediate use when persons are being transferred:

- .1 two manropes of not less than 28 mm and not more than 32 mm in diameter properly secured to the ship if required by the pilot; manropes shall be fixed at the rope end to the ring plate fixed on deck and shall be ready for use when the pilot disembarks, or upon request from a pilot approaching to board (the manropes shall reach the height of the stanchions or bulwarks at the point of access to the deck before terminating at the ring plate on deck);
- .2 a lifebuoy equipped with a self-igniting light;
- .3 a heaving line.

7.2 When required by paragraph 4 above, stanchions and bulwark ladders shall be provided.

8 Lighting

Adequate lighting shall be provided to illuminate the transfer arrangements overside and the position on deck where a person embarks or disembarks.

Regulation 24

Use of heading and/or track control systems

1 In areas of high traffic density, in conditions of restricted visibility and in all other hazardous navigational situations where heading and/or track control systems are in use, it shall be possible to establish manual control of the ship's steering immediately.

2 In circumstances as above, the officer in charge of the navigational watch shall have available without delay the services of a qualified helmsperson who shall be ready at all times to take over steering control.

3 The change-over from automatic to manual steering and vice versa shall be made by, or under the supervision of, a responsible officer.

4 The manual steering shall be tested after prolonged use of heading and/or track control systems and before entering areas where navigation demands special caution.

Regulation 25

Operation of steering gear

In areas where navigation demands special caution, ships shall have more than one steering gear power unit in operation when such units are capable of simultaneous operation.

Regulation 26

Steering gear: testing and drills

1 Within 12 hours before departure, the ship's steering gear shall be checked and tested by the ship's crew. The test procedure shall include, where applicable, the operation of the following:

- .1 the main steering gear;
- .2 the auxiliary steering gear;
- .3 the remote steering gear control systems;
- .4 the steering positions located on the navigation bridge;
- .5 the emergency power supply;
- .6 the rudder angle indicators in relation to the actual position of the rudder;
- .7 the remote steering gear control system power failure alarms;
- .8 the steering gear power unit failure alarms; and
- .9 automatic isolating arrangements and other automatic equipment.

2 The checks and tests shall include:

- .1 the full movement of the rudder according to the required capabilities of the steering gear;
- .2 a visual inspection of the steering gear and its connecting linkage; and
- .3 the operation of the means of communication between the navigation bridge and steering gear compartment.

3.1 Simple operating instructions with a block diagram showing the change-over procedures for remote steering gear control systems and steering gear power units shall be permanently displayed on the navigation bridge and in the steering compartment.

3.2 All ships' officers concerned with the operation and/or maintenance of steering gear shall be familiar with the operation of the steering systems fitted on the ship and with the procedures for changing from one system to another.

4 In addition to the routine checks and tests prescribed in paragraphs 1 and 2, emergency steering drills shall take place at least once every three months in order to practise emergency steering procedures. These drills shall include direct control within the steering gear compartment, the communications procedure with the navigation bridge and, where applicable, the operation of alternative power supplies.

5 The Administration may waive the requirements to carry out the checks and tests prescribed in paragraphs 1 and 2 for ships which regularly engage on voyages of short duration. Such ships shall carry out these checks and tests at least once every week.

6 The date upon which the checks and tests prescribed in paragraphs 1 and 2 are carried out and the date and details of emergency steering drills carried out under paragraph 4 shall be recorded.

Regulation 27

Nautical charts and nautical publications

Nautical charts and nautical publications, such as sailing directions, lists of lights, notices to mariners, tide tables and all other nautical publications necessary for the intended voyage, shall be adequate and up to date.

Regulation 28

Records of navigational activities and daily reporting

1 All ships engaged on international voyages shall keep on board a record of navigational activities and incidents which are of importance to safety of navigation and which must contain sufficient detail to restore a complete record of the voyage, taking into account the recommendations adopted by the Organization.* When such information is not maintained in the ship's logbook, it shall be maintained in another form approved by the Administration.

2 Each ship of 500 gross tonnage and above, engaged on international voyages exceeding 48 hours, shall submit a daily report to its company, as defined in regulation IX/1, which shall retain it and all subsequent daily reports for the duration of the voyage. Daily reports may be transmitted by any means, provided that they are transmitted to the company as soon as practicable after determination of the position named in the report. Automated reporting systems may be used, provided that they include a recording function of their transmission and that those functions and interfaces with position-fixing equipment are subjected to regular verification by the ship's master. The report shall contain the following:

- .1 ship's position;
- .2 ship's course and speed; and
- .3 details of any external or internal conditions that are affecting the ship's voyage or the normal safe operation of the ship.

Regulation 29

Life-saving signals to be used by ships, aircraft or persons in distress

An illustrated table describing the life-saving signals[†] shall be readily available to the officer of the watch of every ship to which this chapter applies. The signals shall be used by ships or persons in distress when communicating with life-saving stations, maritime rescue units and aircraft engaged in search and rescue operations.

Regulation 30

Operational limitations

1 This regulation applies to all passenger ships to which chapter I applies.

2 A list of all limitations on the operation of a passenger ship, including exemptions from any of these regulations, restrictions in operating areas, weather restrictions, sea state restrictions, restrictions in permissible loads, trim, speed and any other limitations, whether imposed by the Administration or established during the

* Refer to *Guidelines for the recording of events related to navigation* (resolution A.916(22)).

† Such life-saving signals are described in the International Aeronautical and Maritime Search and Rescue (IAMSAR) Manual, Volume III, Mobile Facilities, and illustrated in the International Code of Signals, as amended.

design or the building stages, shall be compiled before the passenger ship is put in service. The list, together with any necessary explanations, shall be documented in a form acceptable to the Administration, which shall be kept on board readily available to the master. The list shall be kept updated. If the language used is not English or French, the list shall be provided in one of the two languages.

Regulation 31

Danger messages

- 1 The master of every ship which meets with dangerous ice, a dangerous derelict, or any other direct danger to navigation, or a tropical storm, or encounters sub-freezing air temperatures associated with gale force winds causing severe ice accretion on superstructures, or winds of force 10 or above on the Beaufort scale for which no storm warning has been received, is bound to communicate the information by all means at his disposal to ships in the vicinity, and also to the competent authorities. The form in which the information is sent is not obligatory. It may be transmitted either in plain language (preferably English) or by means of the International Code of Signals.
- 2 Each Contracting Government will take all steps necessary to ensure that when intelligence of any of the dangers specified in paragraph 1 is received, it will be promptly brought to the knowledge of those concerned and communicated to other interested Governments.
- 3 The transmission of messages regarding the dangers specified is free of cost to the ships concerned.
- 4 All radio messages issued under paragraph 1 shall be preceded by the safety signal, using the procedure as prescribed by the Radio Regulations as defined in regulation IV/2.

Regulation 32

Information required in danger messages

The following information is required in danger messages:

- 1 Ice, derelicts and other direct dangers to navigation:
 - .1 The kind of ice, derelict or danger observed.
 - .2 The position of the ice, derelict or danger when last observed.
 - .3 The time and date (Universal Coordinated Time) when the danger was last observed.
- 2 Tropical cyclones (storms):*
 - .1 A statement that a tropical cyclone has been encountered. This obligation should be interpreted in a broad spirit, and information transmitted whenever the master has good reason to believe that a tropical cyclone is developing or exists in the neighbourhood.
 - .2 Time, date (Universal Coordinated Time) and position of ship when the observation was taken.
 - .3 As much of the following information as is practicable should be included in the message:
 - barometric pressure,[†] preferably corrected (stating millibars, millimetres, or inches, and whether corrected or uncorrected);
 - barometric tendency (the change in barometric pressure during the past 3 hours);
 - true wind direction;
 - wind force (Beaufort scale);

* The term *tropical cyclone* is the generic term used by national meteorological services of the World Meteorological Organization. The terms *hurricane*, *typhoon*, *cyclone*, *severe tropical storm*, etc., may also be used, depending on the geographical location.

[†] The standard international unit for barometric pressure is the hectopascal (hPa), which is numerically equivalent to the millibar (mbar).

- state of the sea (smooth, moderate, rough, high);
- swell (slight, moderate, heavy) and the true direction from which it comes. Period or length of swell (short, average, long) would also be of value;
- true course and speed of ship.

Subsequent observations

3 When a master has reported a tropical cyclone or other dangerous storm, it is desirable, but not obligatory, that further observations be made and transmitted hourly, if practicable, but in any case at intervals of not more than 3 hours, so long as the ship remains under the influence of the storm.

4 Winds of force 10 or above on the Beaufort scale for which no storm warning has been received. This is intended to deal with storms other than the tropical cyclones referred to in paragraph 2; when such a storm is encountered, the message should contain similar information to that listed under the paragraph but excluding the details concerning sea and swell.

5 Sub-freezing air temperatures associated with gale force winds causing severe ice accretion on superstructures:

- .1 Time and date (Universal Coordinated Time).
- .2 Air temperature.
- .3 Sea temperature (if practicable).
- .4 Wind force and direction.

Examples

Ice

TTT ICE. LARGE BERG SIGHTED IN 4506 N, 4410 W, AT 0800 UTC. MAY 15.

Derelicts

TTT DERELICT. OBSERVED DERELICT ALMOST SUBMERGED IN 4006 N, 1243 W, AT 1630 UTC. APRIL 21.

Danger to navigation

TTT NAVIGATION. ALPHA LIGHTSHIP NOT ON STATION. 1800 UTC. JANUARY 3.

Tropical cyclone

TTT STORM. 0030 UTC. AUGUST 18. 2004 N, 11354 E. BAROMETER CORRECTED 994 MILLIBARS, TENDENCY DOWN 6 MILLIBARS. WIND NW, FORCE 9, HEAVY SQUALLS. HEAVY EASTERLY SWELL. COURSE 067, 5 KNOTS.

TTT STORM. APPEARANCES INDICATE APPROACH OF HURRICANE. 1300 UTC. SEPTEMBER 14. 2200 N, 7236 W. BAROMETER CORRECTED 29.64 INCHES, TENDENCY DOWN .015 INCHES. WIND NE, FORCE 8, FREQUENT RAIN SQUALLS. COURSE 035, 9 KNOTS.

TTT STORM. CONDITIONS INDICATE INTENSE CYCLONE HAS FORMED. 0200 UTC. MAY 4. 1620 N, 9203 E. BAROMETER UNCORRECTED 753 MILLIMETRES, TENDENCY DOWN 5 MILLIMETRES. WIND S BY W, FORCE 5. COURSE 300, 8 KNOTS.

TTT STORM. TYPHOON TO SOUTHEAST. 0300 UTC. JUNE 12. 1812 N, 12605 E. BAROMETER FALLING RAPIDLY. WIND INCREASING FROM N.

TTT STORM. WIND FORCE 11, NO STORM WARNING RECEIVED. 0300 UTC. MAY 4. 4830 N, 30 W. BAROMETER CORRECTED 983 MILLIBARS, TENDENCY DOWN 4 MILLIBARS. WIND SW, FORCE 11 VEERING. COURSE 260, 6 KNOTS.

Icing

TTT EXPERIENCING SEVERE ICING. 1400 UTC. MARCH 2. 69 N, 10 W. AIR TEMPERATURE 18°F (-7.8°C). SEA TEMPERATURE 29°F (-1.7°C). WIND NE, FORCE 8.

Regulation 33

Distress situations: obligations and procedures

1 The master of a ship at sea which is in a position to be able to provide assistance, on receiving information from any source that persons are in distress at sea, is bound to proceed with all speed to their assistance, if possible informing them or the search and rescue service that the ship is doing so. This obligation to provide assistance applies regardless of the nationality or status of such persons or the circumstances in which they are found. If the ship receiving the distress alert is unable or, in the special circumstances of the case, considers it unreasonable or unnecessary to proceed to their assistance, the master must enter in the logbook the reason for failing to proceed to the assistance of the persons in distress, taking into account the recommendation of the Organization to inform the appropriate search and rescue service accordingly.

1-1 Contracting Governments shall coordinate and cooperate to ensure that masters of ships providing assistance by embarking persons in distress at sea are released from their obligations with minimum further deviation from the ships' intended voyage, provided that releasing the master of the ship from the obligations under the current regulation does not further endanger the safety of life at sea. The Contracting Government responsible for the search and rescue region in which such assistance is rendered shall exercise primary responsibility for ensuring such coordination and cooperation occurs, so that survivors assisted are disembarked from the assisting ship and delivered to a place of safety, taking into account the particular circumstances of the case and guidelines developed by the Organization.* In these cases the relevant Contracting Governments shall arrange for such disembarkation to be effected as soon as reasonably practicable.

2 The master of a ship in distress or the search and rescue service concerned, after consultation, so far as may be possible, with the masters of ships which answer the distress alert, has the right to requisition one or more of those ships as the master of the ship in distress or the search and rescue service considers best able to render assistance, and it shall be the duty of the master or masters of the ship or ships requisitioned to comply with the requisition by continuing to proceed with all speed to the assistance of persons in distress.

3 Masters of ships shall be released from the obligation imposed by paragraph 1 on learning that their ships have not been requisitioned and that one or more other ships have been requisitioned and are complying with the requisition. This decision shall, if possible, be communicated to the other requisitioned ships and to the search and rescue service.

4 The master of a ship shall be released from the obligation imposed by paragraph 1 and, if his ship has been requisitioned, from the obligation imposed by paragraph 2 on being informed by the persons in distress or by the search and rescue service or by the master of another ship which has reached such persons that assistance is no longer necessary.

5 The provisions of this regulation do not prejudice the Convention for the Unification of Certain Rules of Law relating to Assistance and Salvage at Sea, signed at Brussels on 23 September 1910, particularly the obligation to render assistance imposed by article 11 of that Convention.†

6 Masters of ships who have embarked persons in distress at sea shall treat them with humanity, within the capabilities and limitations of the ship.

* Refer to *Guidelines on the treatment of persons rescued at sea* (resolution MSC.167(78)).

† Refer to the International Convention on Salvage, 1989, done at London on 28 April 1989, entered into force on 14 July 1996.

Regulation 34

Safe navigation and avoidance of dangerous situations

- 1 Prior to proceeding to sea, the master shall ensure that the intended voyage has been planned using the appropriate nautical charts and nautical publications for the area concerned, taking into account the guidelines and recommendations developed by the Organization.*
- 2 The voyage plan shall identify a route which:
 - .1 takes into account any relevant ships' routeing systems;
 - .2 ensures sufficient sea room for the safe passage of the ship throughout the voyage;
 - .3 anticipates all known navigational hazards and adverse weather conditions; and
 - .4 takes into account the marine environmental protection measures that apply, and avoids, as far as possible, actions and activities which could cause damage to the environment.

Regulation 34-1

Master's discretion

The owner, the charterer, the company operating the ship as defined in regulation IX/1, or any other person shall not prevent or restrict the master of the ship from taking or executing any decision which, in the master's professional judgement, is necessary for safety of life at sea and protection of the marine environment.

Regulation 35

Misuse of distress signals

The use of an international distress signal, except for the purpose of indicating that a person or persons are in distress, and the use of any signal which may be confused with an international distress signal are prohibited.

* Refer to *Guidelines for voyage planning* (resolution A.893(21)).

Appendix

Rules for the management, operation and financing of the North Atlantic Ice Patrol

1 In these Rules:

- .1 *Ice season* means the annual period between 15 February and 1 July.
- .2 *Region of icebergs guarded by the Ice Patrol* means the south-eastern, southern and south-western limits of the region of icebergs in the vicinity of the Grand Banks of Newfoundland.
- .3 *Routes passing through regions of icebergs guarded by the Ice Patrol* means:
 - .1 routes between Atlantic coast ports of Canada (including inland ports approached from the North Atlantic through the Gut of Canso and Cabot Straits) and ports of Europe, Asia or Africa approached from the North Atlantic through or north of the Straits of Gibraltar (except routes which pass south of the extreme limits of ice of all types);
 - .2 routes via Cape Race, Newfoundland, between Atlantic coast ports of Canada (including inland ports approached from the North Atlantic through the Gut of Canso and Cabot Straits) west of Cape Race, Newfoundland, and Atlantic coast ports of Canada north of Cape Race, Newfoundland;
 - .3 routes between Atlantic and Gulf Coast ports of the United States of America (including inland ports approached from the North Atlantic through the Gut of Canso and Cabot Straits) and ports of Europe, Asia or Africa approached from the North Atlantic through or north of the Straits of Gibraltar (except routes which pass south of the extreme limits of ice of all types);
 - .4 routes via Cape Race, Newfoundland, between Atlantic and Gulf Coast ports of the United States of America (including inland ports approached from the North Atlantic through the Gut of Canso and Cabot Straits) and Atlantic Coast ports of Canada north of Cape Race, Newfoundland.
- .4 *Extreme limits of ice of all types* in the North Atlantic Ocean is defined by a line connecting the following points:

A – 42° 23'.00 N, 59° 25'.00 W	J – 39° 49'.00 N, 41° 00'.00 W
B – 41° 23'.00 N, 57° 00'.00 W	K – 40° 39'.00 N, 39° 00'.00 W
C – 40° 47'.00 N, 55° 00'.00 W	L – 41° 19'.00 N, 38° 00'.00 W
D – 40° 07'.00 N, 53° 00'.00 W	M – 43° 00'.00 N, 37° 27'.00 W
E – 39° 18'.00 N, 49° 39'.00 W	N – 44° 00'.00 N, 37° 29'.00 W
F – 38° 00'.00 N, 47° 35'.00 W	O – 46° 00'.00 N, 37° 55'.00 W
G – 37° 41'.00 N, 46° 40'.00 W	P – 48° 00'.00 N, 38° 28'.00 W
H – 38° 00'.00 N, 45° 33'.00 W	Q – 50° 00'.00 N, 39° 07'.00 W
I – 39° 05'.00 N, 43° 00'.00 W	R – 51° 25'.00 N, 39° 45'.00 W.
- .5 *Managing and operating* means maintaining, administering and operating the Ice Patrol, including the dissemination of information received therefrom.
- .6 *Contributing Government* means a Contracting Government undertaking to contribute to the costs of the Ice Patrol Service pursuant to these Rules.

2 Each Contracting Government specially interested in these services whose ships pass through the region of icebergs during the ice season undertakes to contribute to the Government of the United States of America its proportionate share of the costs for the management and operation of the Ice Patrol Service. The contribution to the Government of the United States of America shall be based on the ratio which the average

annual gross tonnage of that contributing Government's ships passing through the region of icebergs guarded by the Ice Patrol during the previous three ice seasons bears to the combined average annual gross tonnage of all ships that passed through the region of icebergs guarded by the Ice Patrol during the previous three ice seasons.

3 All contributions shall be calculated by multiplying the ratio described in paragraph 2 by the average actual annual cost incurred by the Governments of the United States of America and Canada of managing and operating ice patrol services during the previous three years. This ratio shall be computed annually, and shall be expressed in terms of a lump sum per-annum fee.

4 Each of the contributing Governments has the right to alter or discontinue its contribution, and other interested Governments may undertake to contribute to the expense. The contributing Government which avails itself of this right will continue to be responsible for its current contribution up to 1 September following the date of giving notice of intention to alter or discontinue its contribution. To take advantage of the said right it must give notice to the managing Government at least six months before the said 1 September.

5 Each contributing Government shall notify the Secretary-General of its undertaking pursuant to paragraph 2, who shall notify all Contracting Governments.

6 The Government of the United States of America shall furnish annually to each contributing Government a statement of the total cost incurred by the Governments of the United States of America and Canada of managing and operating the Ice Patrol for that year and of the average percentage share for the past three years of each contributing Government.

7 The managing Government shall publish annual accounts including a statement of costs incurred by the Governments providing the services for the past three years and the total gross tonnage using the service for the past three years. The accounts shall be publicly available. Within three months after having received the cost statement, contributing Governments may request more detailed information regarding the costs incurred in managing and operating the Ice Patrol.

8 These Rules shall be operative beginning with the ice season of 2002.



Unified Interpretations for Chapter V

- 1 Annual performance test of voyage data recorder (VDR) and simplified voyage data recorder (S-VDR)** *(Source: MSC.1/Circ.1576)*
- Reg. 18.8 The annual performance test of VDR (or S-VDR) shall be carried out within the "time window" of the annual/periodical/renewal survey under the Harmonized System of Survey and Certification (HSSC), but not later than the date of completion of the survey for endorsement/renewal of the relevant Certificate.
- 2 Annual performance test of automatic identification system (AIS)** *(Source: MSC.1/Circ.1576)*
- Reg. 18.9 The annual performance test of the AIS shall be carried out within the "time window" of the annual/periodical/renewal survey under the Harmonized System of Survey and Certification (HSSC), but not later than the date of completion of the survey for endorsement/renewal of the relevant Certificate.
- 3 Carriage requirements for shipborne navigational systems and equipment** *(Source: MSC.1/Circ.1429)*
- Regs. 19.2.3.4, 19.2.9.2 3.1 SOLAS regulation V/19 requires that speed and distance measuring devices shall be fitted as follows:
- .1 ships of 300 gross tonnage and upwards and passenger ships irrespective of size for measuring speed through the water (SOLAS regulation V/19.2.3.4); and
 - .2 ships of 50,000 gross tonnage and upwards for measuring speed over the ground in the forward and athwartships direction (SOLAS regulation V/19.2.9.2).
- 3.2 As described in paragraph 3.1 above, SOLAS requires all ships of 50,000 gross tonnage and upwards to be fitted with a speed and distance measuring device fulfilling SOLAS regulation V/19.2.3.4 and, in addition, a speed and distance measuring device fulfilling regulation V/19.2.9.2.
- 3.3 The Maritime Safety Committee, at its ninetieth session (16 to 25 May 2012), taking into account the advice provided by the Sub-Committee on Safety of Navigation, at its fifty-seventh session (6 to 10 June 2011), agreed that both regulations should be fulfilled by two separate devices, i.e. one speed and distance measuring and indicating device capable of measuring speed through water and one separate speed and distance measuring and indicating device capable of measuring speed over the ground in the forward and athwartships direction.
- 4 Navigation bridge visibility** *(Source: MSC-MEPC.2/Circ.10)*
- Reg. 22 For single-hull oil tanker conversion into double-hull oil tanker or bulk carrier, the level of visibility possessed by the ship prior to the conversion at the ballast loading condition should be maintained after the conversion. Where a conversion involves the modification of structural arrangements used to establish minimum bridge visibility, the provisions of SOLAS regulation V/22 should apply.
- 5 Navigation bridge visibility** *(Source: MSC.1/Circ.1350/Rev.1)*
- Reg. 22.1.6 5.1 The requirements of SOLAS regulation V/22.1.6 are accomplished when:
- .1 a view from the bridge wing plus a distance corresponding to a reasonable and safe distance of a seafarer leaning over the side of the bridge wing, which needs not to be more than 400 mm, to the location vertically right under the maximum beam of the ship at the lowest seagoing draught is not obscured; or
 - .2 the sea surface at the lowest seagoing draught and with a transverse distance of 500 mm and more from the maximum beam throughout the ship's length is visible from the side of the bridge wing.
- 5.2 A schematic diagram depicting the unified interpretations is shown in figure 1.
- 5.3 For particular types of ships such as tug/tow boat, offshore supply vessel (OSV), rescue ship, work ship (e.g. floating crane), in meeting the requirements of SOLAS regulation V/22.1.6, the bridge wings should at least extend to a location from which the sea surface, at the lowest seagoing draught and at a transverse distance of 1,500 mm from the maximum beam throughout the ship's length, is visible. If this ship type is changed to a type other than those addressed in this paragraph then the interpretation in this paragraph would no longer apply.

5.4 The use of a remote camera system may be accepted for ships of unconventional design, other than those mentioned in paragraph 5.3 above, as means for achieving the view of the ship's side from the bridge wing, provided:

- the installed remote camera system is to be redundant from the circuit breaker to the camera and screen, including communication cables, i.e. the system is to provide on each side of the ship redundancy of:
 - the power cables and circuit breakers from the main switchboard to the camera and the screen;
 - the camera;
 - the screen;
 - the transmission lines from the camera to the display screen; and
 - the components associated with these lines and cables;
- the remote camera system is powered from the ship's main source of electrical power and is not required to be powered by the emergency source of electrical power;
- the remote camera system is capable of continuous operation under environmental conditions as per UR E10;
- the view provided by the remote camera system complies with the requirements of regulation V/22.1.6 and is also displayed at locations where the manoeuvring of the ship may take place;
- the upper edge of the ship's side abeam is directly visible by the observer from locations where the manoeuvring of the ship may take place.

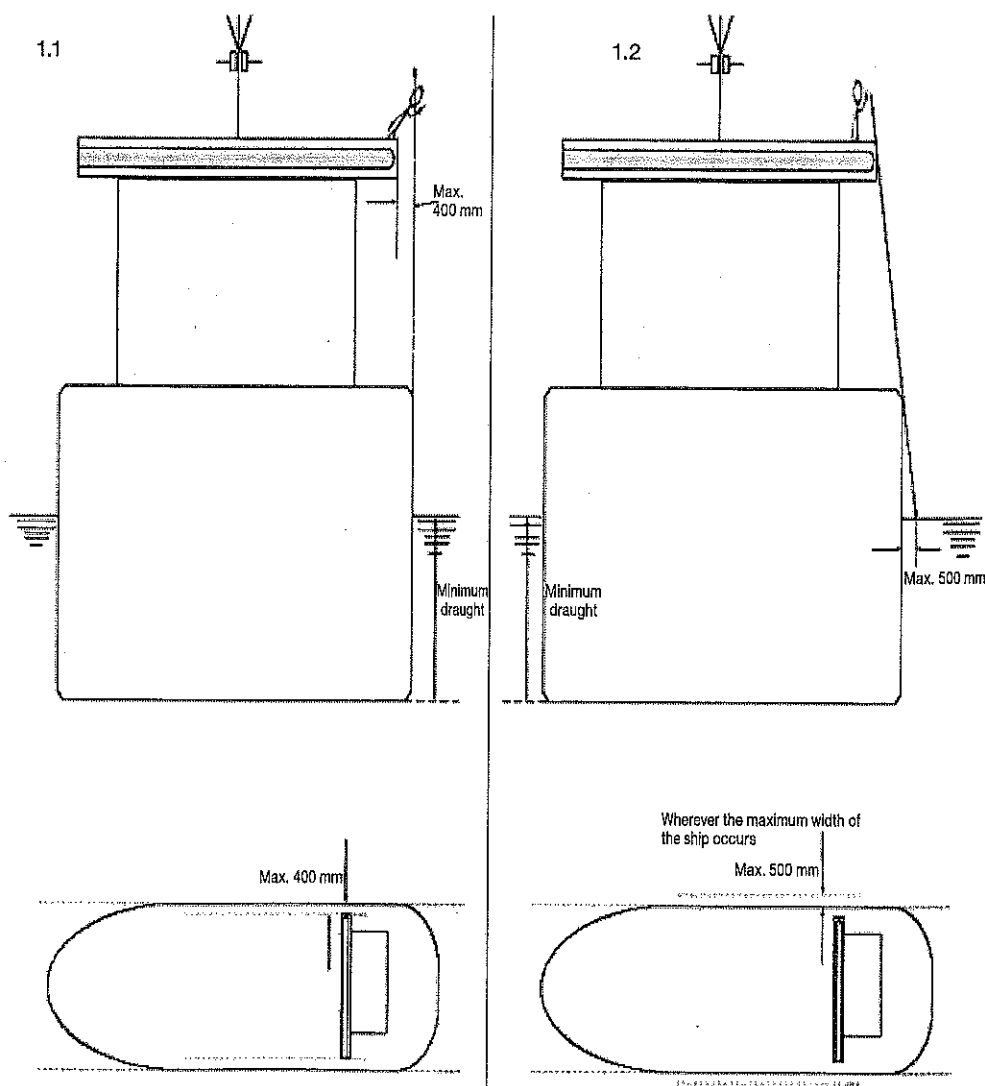

Figure 1

6 Pilot transfer arrangements*(Source: MSC.1/Circ.1375/Rev.1)***Reg. 23**

6.1 For ships for which the building contract is placed on or after 1 July 2012, or in the absence of the contract, constructed on or after 1 July 2012, "installed on or after 1 July 2012" means any installation on the ship; and

6.2 For ships other than those ships prescribed in 6.1 above, "installed on or after 1 July 2012" means a contractual delivery date for the system, in its entirety or for individual components of the system, as relevant, to the ship on or after 1 July 2012 or, in the absence of a contractual delivery date, the actual delivery of the system, in its entirety or for individual components, to the ship on or after 1 July 2012. This does not apply to equipment and arrangements covered by paragraph 1.4 of regulation V/23.

7 Pilot transfer arrangements*(Source: MSC.1/Circ.1495/Rev.1)***Reg. 23.3.3**

Sub-paragraphs 1 and 2 of SOLAS regulation V/23.3.3 address two different and distinct arrangements – the former when only a pilot ladder is provided; the latter when a combined arrangement of "an accommodation ladder used in conjunction with the pilot ladder" is provided.

7.1 SOLAS regulation V/23.3.3.1 prescribes an operational instruction that limits the climb to not more than 9 m on a single ladder regardless of the trim or list of the ship.

7.2 SOLAS regulation V/23.3.3.2 and section 3 of resolution A.1045(27), as amended, applies to a combined arrangement of "an accommodation ladder used in conjunction with the pilot ladder" for "Safe and convenient access to, and egress from, the ship" for which a 15° list requirement does not apply.

V

Chapter VI

Carriage of cargoes and oil fuels

Chapter VI

Carriage of cargoes and oil fuels

Part A	General provisions	
Regulation 1	Application	391
Regulation 1-1	Definitions.	391
Regulation 1-2	Requirements for the carriage of solid bulk cargoes other than grain.	391
Regulation 2	Cargo information	392
Regulation 3	Oxygen analysis and gas detection equipment.	393
Regulation 4	The use of pesticides in ships.	393
Regulation 5	Stowage and securing	393
Regulation 5-1	Material safety data sheets.	394
Regulation 5-2	Prohibition of the blending of bulk liquid cargoes and production processes during sea voyages	394
Part B	Special provisions for solid bulk cargoes	
Regulation 6	Acceptability for shipment.	395
Regulation 7	Loading, unloading and stowage of solid bulk cargoes	395
Part C	Carriage of grain	
Regulation 8	Definitions.	397
Regulation 9	Requirements for cargo ships carrying grain	397

VI

Part A

General provisions

Regulation 1

Application

1 Unless expressly provided otherwise, this chapter applies to the carriage of cargoes (except liquids in bulk, gases in bulk and those aspects of carriage covered by other chapters) which, owing to their particular hazards to ships or persons on board, may require special precautions in all ships to which the present regulations apply and in cargo ships of less than 500 gross tonnage. However, for cargo ships of less than 500 gross tonnage, the Administration, if it considers that the sheltered nature and conditions of voyage are such as to render the application of any specific requirements of part A or B of this chapter unreasonable or unnecessary, may take other effective measures to ensure the required safety for these ships.

2 To supplement the provisions of parts A and B of this chapter, each Contracting Government shall ensure that appropriate information on cargo and its stowage and securing is provided, specifying, in particular, precautions necessary for the safe carriage of such cargoes.*

Regulation 1-1

Definitions

For the purpose of this chapter, unless expressly provided otherwise, the following definitions shall apply:

1 *IMSBC Code* means the International Maritime Solid Bulk Cargoes (IMSBC) Code adopted by the Maritime Safety Committee of the Organization by resolution MSC.268(85), as may be amended by the Organization, provided that such amendments are adopted, brought into force and take effect in accordance with the provisions of article VIII of the present Convention concerning the amendment procedures applicable to the annex other than chapter I.

2 *Solid bulk cargo* means any cargo, other than liquid or gas, consisting of a combination of particles, granules or any larger pieces of material generally uniform in composition, which is loaded directly into the cargo spaces of a ship without any intermediate form of containment.

Regulation 1-2

Requirements for the carriage of solid bulk cargoes other than grain

The carriage of solid bulk cargoes other than grain shall be in compliance with the relevant provisions of the IMSBC Code.

* Refer to:

- .1 the *Code of Safe Practice for Cargo Stowage and Securing* (resolution A.714(17), as amended);
- .2 the *Code of Safe Practice for Ships Carrying Timber Deck Cargoes, 2011* (2011 TDC Code) (resolution A.1048(27)), *Guidance note on precautions to be taken by the masters of ships of below 100 metres in length engaged in the carriage of logs* (MSC/Circ.525), and *Guidance note on precautions to be taken by masters of ships engaged in the carriage of timber cargoes* (MSC/Circ.548); and
- .3 the *IMSBC Code* (resolution MSC.268(85), as amended).

Regulation 2 Cargo information

- 1 The shipper shall provide the master or his representative with appropriate information on the cargo sufficiently in advance of loading to enable the precautions which may be necessary for proper stowage and safe carriage of the cargo to be put into effect. Such information* shall be confirmed in writing† and by appropriate shipping documents prior to loading the cargo on the ship.
- 2 The cargo information shall include:
 - .1 in the case of general cargo, and of cargo carried in cargo units, a general description of the cargo, the gross mass of the cargo or of the cargo units, and any relevant special properties of the cargo. For the purpose of this regulation the cargo information required in sub-chapter 1.9 of the Code of Safe Practice for Cargo Stowage and Securing, adopted by the Organization by resolution A.714(17), as may be amended, shall be provided. Any such amendment to sub-chapter 1.9 shall be adopted, brought into force and take effect in accordance with the provisions of article VIII of the present Convention concerning the amendment procedures applicable to the annex other than chapter I;
 - .2 in the case of solid bulk cargo, information as required by section 4 of the IMSBC Code.
- 3 Prior to loading cargo units on board ships, the shipper shall ensure that the gross mass of such units is in accordance with the gross mass declared on the shipping documents.
- 4 In the case of cargo carried in a container,‡ except for containers carried on a chassis or a trailer when such containers are driven on or off a ro-ro ship engaged in short international voyages as defined in regulation III/3, the gross mass according to paragraph 2.1 of this regulation shall be verified by the shipper, either by:
 - .1 weighing the packed container using calibrated and certified equipment; or
 - .2 weighing all packages and cargo items, including the mass of pallets, dunnage and other securing material to be packed in the container and adding the tare mass of the container to the sum of the single masses, using a certified method approved by the competent authority of the State in which packing of the container was completed.
- 5 The shipper of a container shall ensure the verified gross mass§ is stated in the shipping document. The shipping document shall be:
 - .1 signed by a person duly authorized by the shipper; and
 - .2 submitted to the master or his representative and to the terminal representative sufficiently in advance, as required by the master or his representative, to be used in the preparation of the ship stowage plan.¶
- 6 If the shipping document, with regard to a packed container, does not provide the verified gross mass and the master or his representative and the terminal representative have not obtained the verified gross mass of the packed container, it shall not be loaded on to the ship.

* Refer to *Form for cargo information* (MSC/Circ.663).

† Reference to documents in this regulation does not preclude the use of electronic data processing (EDP) and electronic data interchange (EDI) transmission techniques as an aid to paper documentation.

‡ The term *container* should be considered as having the same meaning as defined and applied in the International Convention for Safe Containers (CSC), 1972, as amended, taking into account *Guidelines for the approval of offshore containers handled in open seas* (MSC/Circ.860) and *Revised recommendations on harmonized interpretation and implementation of the International Convention for Safe Containers, 1972, as amended* (CSC.1/Circ.138/Rev.1).

§ Refer to *Guidelines regarding the verified gross mass of a container carrying cargo* (MSC.1/Circ.1475).

¶ This document may be presented by means of EDP or EDI transmission techniques. The signature may be an electronic signature or may be replaced by the name, in capitals, of the person authorized to sign.

Regulation 3*Oxygen analysis and gas detection equipment*

- 1 When transporting a solid bulk cargo which is liable to emit a toxic or flammable gas, or cause oxygen depletion in the cargo space, an appropriate instrument for measuring the concentration of gas or oxygen in the air shall be provided together with detailed instructions for its use. Such an instrument shall be to the satisfaction of the Administration.
- 2 The Administration shall take steps to ensure that crews of ships are trained in the use of such instruments.

Regulation 4*The use of pesticides in ships**

Appropriate precautions shall be taken in the use of pesticides in ships, in particular for the purposes of fumigation.

Regulation 5*Stowage and securing*

- 1 Cargo, cargo units[†] and cargo transport units[‡] carried on or under deck shall be so loaded, stowed and secured as to prevent as far as is practicable, throughout the voyage, damage or hazard to the ship and the persons on board, and loss of cargo overboard.
- 2 Cargo, cargo units and cargo transport units shall be so packed and secured within the unit as to prevent, throughout the voyage, damage or hazard to the ship and the persons on board.
- 3 Appropriate precautions shall be taken during loading and transport of heavy cargoes or cargoes with abnormal physical dimensions to ensure that no structural damage to the ship occurs and to maintain adequate stability throughout the voyage.
- 4 Appropriate precautions shall be taken during loading and transport of cargo units and cargo transport units on board ro-ro ships, especially with regard to the securing arrangements on board such ships and on the cargo units and cargo transport units and with regard to the strength of the securing points and lashings.
- 5 Freight containers shall not be loaded to more than the maximum gross weight indicated on the Safety Approval Plate under the International Convention for Safe Containers (CSC), as amended.
- 6 All cargoes, other than solid and liquid bulk cargoes, cargo units and cargo transport units, shall be loaded, stowed and secured throughout the voyage in accordance with the Cargo Securing Manual approved by the Administration. In ships with ro-ro spaces, as defined in regulation II-2/3.41, all securing of such cargoes, cargo units, and cargo transport units, in accordance with the Cargo Securing Manual, shall be completed before the ship leaves the berth. The Cargo Securing Manual shall be drawn up to a standard at least equivalent to relevant guidelines developed by the Organization.[§]

* Refer to:

- .1 *Revised recommendations on the safe use of pesticides in ships* (MSC.1/Circ.1358);
- .2 *Recommendations on the safe use of pesticides in ships applicable to the fumigation of cargo holds* (MSC.1/Circ.1264, as amended); and
- .3 *Revised recommendations on the safe use of pesticides in ships applicable to the fumigation of cargo transport units* (MSC.1/Circ.1361).

[†] Refer to the *Code of Safe Practice for Cargo Stowage and Securing* (resolution A.714(17), as amended).

[‡] Refer to the *International Maritime Dangerous Goods (IMDG) Code* (resolution MSC.122(75), as amended).

[§] Refer to *Revised guidelines for the preparation of the Cargo Securing Manual* (MSC.1/Circ.1353).

Regulation 5-1

Material safety data sheets

Ships carrying oil or oil fuel, as defined in regulation 1 of Annex I of the International Convention for the Prevention of Pollution from Ships, 1973, as modified by the Protocol of 1978 relating thereto, shall be provided with material safety data sheets, based on the recommendations developed by the Organization,* prior to the loading of such oil as cargo in bulk or bunkering of oil fuel.

Regulation 5-2

Prohibition of the blending of bulk liquid cargoes and production processes during sea voyages

1 The physical blending of bulk liquid cargoes during sea voyages is prohibited. Physical blending refers to the process whereby the ship's cargo pumps and pipelines are used to internally circulate two or more different cargoes with the intent to achieve a cargo with a new product designation. This prohibition does not preclude the master from undertaking cargo transfers for the safety of the ship or protection of the marine environment.

2 The prohibition in paragraph 1 does not apply to the blending of products for use in the search and exploitation of seabed mineral resources on board ships used to facilitate such operations.

3 Any production process on board a ship during sea voyages is prohibited. Production processes refer to any deliberate operation whereby a chemical reaction between a ship's cargo and any other substance or cargo takes place.

4 The prohibition in paragraph 3 does not apply to the production processes of cargoes for use in the search and exploitation of seabed mineral resources on board ships used to facilitate such operations.†

* Refer to *Recommendations for material safety data sheets (MSDS) for MARPOL Annex I oil cargo and oil fuel* (resolution MSC.286(86), as may be amended).

† Refer to *Guidelines for the transport and handling of limited amounts of hazardous and noxious liquid substances in bulk in offshore support vessels* (resolution A.673(16), as amended).

Part B

Special provisions for solid bulk cargoes

Regulation 6

Acceptability for shipment

1 Prior to loading a solid bulk cargo, the master shall be in possession of comprehensive information on the ship's stability and on the distribution of cargo for the standard loading conditions. The method of providing such information shall be to the satisfaction of the Administration.*

Regulation 7

Loading, unloading and stowage of solid bulk cargoes†

1 For the purpose of this regulation, *terminal representative* means a person appointed by the terminal or other facility, where the ship is loading or unloading, who has responsibility for operations conducted by that terminal or facility with regard to the particular ship.

2 To enable the master to prevent excessive stresses in the ship's structure, the ship shall be provided with a booklet, which shall be written in a language with which the ship's officers responsible for cargo operations are familiar. If this language is not English, the ship shall be provided with a booklet written also in the English language. The booklet shall, as a minimum, include:

- .1 stability data, as required by regulation II-1/5-1;
- .2 ballasting and deballasting rates and capacities;
- .3 maximum allowable load per unit surface area of the tank top plating;
- .4 maximum allowable load per hold;
- .5 general loading and unloading instructions with regard to the strength of the ship's structure including any limitations on the most adverse operating conditions during loading, unloading, ballasting operations and the voyage;
- .6 any special restrictions such as limitations on the most adverse operating conditions imposed by the Administration or organization recognized by it, if applicable; and
- .7 where strength calculations are required, maximum permissible forces and moments on the ship's hull during loading, unloading and the voyage.

3 Before a solid bulk cargo is loaded or unloaded, the master and the terminal representative shall agree on a plan† which shall ensure that the permissible forces and moments on the ship are not exceeded during loading or unloading, and shall include the sequence, quantity and rate of loading or unloading, taking into consideration the speed of loading or unloading, the number of pours and the deballasting or ballasting capability of the ship. The plan and any subsequent amendments thereto shall be lodged with the appropriate authority of the port State.

* Refer to regulation II-1/5-1 on Stability information to be supplied to the master.

† Refer to the *Code of Practice for the Safe Loading and Unloading of Bulk Carriers* (BLU Code) (resolution A.862(20), as amended).

4 The master and terminal representative shall ensure that loading and unloading operations are conducted in accordance with the agreed plan.

5 If during loading or unloading any of the limits of the ship referred to in paragraph 2 are exceeded or are likely to become so if the loading or unloading continues, the master has the right to suspend operation and the obligation to notify accordingly the appropriate authority of the port State with which the plan has been lodged. The master and the terminal representative shall ensure that corrective action is taken. When unloading cargo, the master and terminal representative shall ensure that the unloading method does not damage the ship's structure.

6 The master shall ensure that ship's personnel continuously monitor cargo operations. Where possible, the ship's draught shall be checked regularly during loading or unloading to confirm the tonnage figures supplied. Each draught and tonnage observation shall be recorded in a cargo logbook. If significant deviations from the agreed plan are detected, cargo or ballast operations or both shall be adjusted to ensure that the deviations are corrected.

Part C

Carriage of grain

Regulation 8

Definitions

For the purposes of this part, unless expressly provided otherwise:

- 1 *International Grain Code* means the International Code for the Safe Carriage of Grain in Bulk adopted by the Maritime Safety Committee of the Organization by resolution MSC.23(59) as may be amended by the Organization, provided that such amendments are adopted, brought into force and take effect in accordance with the provisions of article VIII of the present Convention concerning the amendment procedures applicable to the annex other than chapter I.
- 2 The term *grain* includes wheat, maize (corn), oats, rye, barley, rice, pulses, seeds and processed forms thereof whose behaviour is similar to that of grain in its natural state.

Regulation 9

Requirements for cargo ships carrying grain

- 1 In addition to any other applicable requirements of the present regulations, a cargo ship carrying grain shall comply with the requirements of the International Grain Code, and hold a document of authorization as required by that Code. For the purpose of this regulation, the requirements of the Code shall be treated as mandatory.
- 2 A ship without such a document shall not load grain until the master satisfies the Administration, or the Contracting Government of the port of loading on behalf of the Administration, that the ship will comply with the requirements of the International Grain Code in its proposed loaded condition.

VI

Chapter VII

Carriage of dangerous goods

Chapter VII

Carriage of dangerous goods*

Part A	Carriage of dangerous goods in packaged form	
Regulation 1	Definitions	403
Regulation 2	Application	403
Regulation 3	Requirements for the carriage of dangerous goods	403
Regulation 4	Documents	404
Regulation 5	Cargo Securing Manual	404
Regulation 6	Reporting of incidents involving dangerous goods	404
Part A-1	Carriage of dangerous goods in solid form in bulk	
Regulation 7	Definitions	405
Regulation 7-1	Application	405
Regulation 7-2	Documents	405
Regulation 7-3	Stowage and segregation requirements	405
Regulation 7-4	Reporting of incidents involving dangerous goods	406
Regulation 7-5	Requirements for the carriage of dangerous goods in solid form in bulk	406
Part B	Construction and equipment of ships carrying dangerous liquid chemicals in bulk	
Regulation 8	Definitions	407
Regulation 9	Application to chemical tankers	407
Regulation 10	Requirements for chemical tankers	408
Part C	Construction and equipment of ships carrying liquefied gases in bulk	
Regulation 11	Definitions	409
Regulation 12	Application to gas carriers	409
Regulation 13	Requirements for gas carriers	410
Part D	Special requirements for the carriage of packaged irradiated nuclear fuel, plutonium and high-level radioactive wastes on board ships	
Regulation 14	Definitions	411
Regulation 15	Application to ships carrying INF cargo	411
Regulation 16	Requirements for ships carrying INF cargo	412

* Refer to *General principles for ship reporting systems and ship reporting requirements, including guidelines for reporting incidents involving dangerous goods, harmful substances and/or marine pollutants* (resolution A.851(20), as amended).

Part A

Carriage of dangerous goods in packaged form

Regulation 1

Definitions

For the purpose of this chapter, unless expressly provided otherwise:

- 1 *IMDG Code* means the International Maritime Dangerous Goods (IMDG) Code adopted by the Maritime Safety Committee of the Organization by resolution MSC.122(75), as may be amended by the Organization, provided that such amendments are adopted, brought into force and take effect in accordance with the provisions of article VIII of the present Convention concerning the amendment procedures applicable to the annex other than chapter I.
- 2 *Dangerous goods* mean the substances, materials and articles covered by the IMDG Code.
- 3 *Packaged form* means the form of containment specified in the IMDG Code.

Regulation 2

*Application**

- 1 Unless expressly provided otherwise, this part applies to the carriage of dangerous goods in packaged form in all ships to which the present regulations apply and in cargo ships of less than 500 gross tonnage.
- 2 The provisions of this part do not apply to ships' stores and equipment.
- 3 The carriage of dangerous goods in packaged form is prohibited except in accordance with the provisions of this chapter.
- 4 To supplement the provisions of this part, each Contracting Government shall issue, or cause to be issued, detailed instructions on emergency response and medical first aid relevant to incidents involving dangerous goods in packaged form, taking into account the guidelines developed by the Organization.†

Regulation 3

Requirements for the carriage of dangerous goods

The carriage of dangerous goods in packaged form shall be in compliance with the relevant provisions of the IMDG Code.

* Refer to:

- .1 part D, which contains special requirements for the carriage of INF cargo; and
- .2 regulation II-2/19, which contains special requirements for ships carrying dangerous goods.

† Refer to:

- .1 the *Revised Emergency Response Procedures for Ships Carrying Dangerous Goods (EmS Guide)* (MSC.1/Circ.1588); and
- .2 the *Medical First Aid Guide for Use in Accidents Involving Dangerous Goods (MFAG)* which is reproduced in the Supplement to the IMDG Code published by the Organization.

Regulation 4

Documents

1 Transport information relating to the carriage of dangerous goods in packaged form and the container/vehicle packing certificate shall be in accordance with the relevant provisions of the IMDG Code and shall be made available to the person or organization designated by the port State authority.

2 Each ship carrying dangerous goods in packaged form shall have a special list, manifest or stowage plan setting forth, in accordance with the relevant provisions of the IMDG Code, the dangerous goods on board and the location thereof. A copy of one of these documents shall be made available before departure to the person or organization designated by the port State authority.

Regulation 5

Cargo Securing Manual

Cargo, cargo units* and cargo transport units shall be loaded, stowed and secured throughout the voyage in accordance with the Cargo Securing Manual approved by the Administration. The Cargo Securing Manual shall be drawn up to a standard at least equivalent to the guidelines developed by the Organization.†

Regulation 6

Reporting of incidents involving dangerous goods

1 When an incident takes place involving the loss or likely loss overboard of dangerous goods in packaged form into the sea, the master, or other person having charge of the ship, shall report the particulars of such an incident without delay and to the fullest extent possible to the nearest coastal State. The report shall be drawn up based on general principles and guidelines developed by the Organization.‡

2 In the event of the ship referred to in paragraph 1 being abandoned, or in the event of a report from such a ship being incomplete or unobtainable, the company, as defined in regulation IX/1.2, shall, to the fullest extent possible, assume the obligations placed upon the master by this regulation.

* As defined in the *Code of Safe Practice for Cargo Stowage and Securing* (resolution A.714(17), as amended).

† Refer to *Revised guidelines for the preparation of the Cargo Securing Manual* (MSC/Circ.1353).

‡ Refer to *General principles for ship reporting systems and ship reporting requirements, including guidelines for reporting incidents involving dangerous goods, harmful substances and/or marine pollutants* (resolution A.851(20), as amended).

Part A-1

Carriage of dangerous goods in solid form in bulk

Regulation 7

Definitions

Dangerous goods in solid form in bulk means any material, other than liquid or gas, consisting of a combination of particles, granules or any larger pieces of material, generally uniform in composition, which is covered by the IMDG Code and is loaded directly into the cargo spaces of a ship without any intermediate form of containment, and includes such materials loaded in a barge on a barge-carrying ship.

Regulation 7-1

*Application**

- 1 Unless expressly provided otherwise, this part applies to the carriage of dangerous goods in solid form in bulk in all ships to which the present regulations apply and in cargo ships of less than 500 gross tonnage.
- 2 The carriage of dangerous goods in solid form in bulk is prohibited except in accordance with the provisions of this part.
- 3 To supplement the provisions of this part, each Contracting Government shall issue, or cause to be issued, instructions on emergency response and medical first aid relevant to incidents involving dangerous goods in solid form in bulk, taking into account the guidelines developed by the Organization.†

Regulation 7-2

Documents

- 1 In all documents relating to the carriage of dangerous goods in solid form in bulk by sea, the bulk cargo shipping name of the goods shall be used (trade names alone shall not be used).
- 2 Each ship carrying dangerous goods in solid form in bulk shall have a special list or manifest setting forth the dangerous goods on board and the location thereof. A detailed stowage plan, which identifies by class and sets out the location of all dangerous goods on board, may be used in place of such a special list or manifest. A copy of one of these documents shall be made available before departure to the person or organization designated by the port State authority.

Regulation 7-3

Stowage and segregation requirements

- 1 Dangerous goods in solid form in bulk shall be loaded and stowed safely and appropriately in accordance with the nature of the goods. Incompatible goods shall be segregated from one another.
- 2 Dangerous goods in solid form in bulk, which are liable to spontaneous heating or combustion, shall not be carried unless adequate precautions have been taken to minimize the likelihood of the outbreak of fire.

* Refer to regulation II-2/19, which contains special requirements for ships carrying dangerous goods.

† Refer to the *Medical First Aid Guide for Use in Accidents Involving Dangerous Goods (MFAG)* which is reproduced in the Supplement to the IMDG Code published by the Organization.

3 Dangerous goods in solid form in bulk, which give off dangerous vapours, shall be stowed in a well-ventilated cargo space.

Regulation 7-4

Reporting of incidents involving dangerous goods

1 When an incident takes place involving the loss or likely loss overboard of dangerous goods in solid form in bulk into the sea, the master, or other person having charge of the ship, shall report the particulars of such an incident without delay and to the fullest extent possible to the nearest coastal State. The report shall be drawn up based on general principles and guidelines developed by the Organization.*

2 In the event of the ship referred to in paragraph 1 being abandoned, or in the event of a report from such a ship being incomplete or unobtainable, the company, as defined in regulation IX/1.2, shall, to the fullest extent possible, assume the obligations placed upon the master by this regulation.

Regulation 7-5

Requirements for the carriage of dangerous goods in solid form in bulk

The carriage of dangerous goods in solid form in bulk shall be in compliance with the relevant provisions of the IMSBC Code, as defined in regulation VI/1-1.1.

* Refer to *General principles for ship reporting systems and ship reporting requirements, including guidelines for reporting incidents involving dangerous goods, harmful substances and/or marine pollutants* (resolution A.851(20), as amended).

Part B

Construction and equipment of ships carrying dangerous liquid chemicals in bulk

Regulation 8

Definitions

For the purpose of this part, unless expressly provided otherwise:

- 1 *International Bulk Chemical Code (IBC Code)* means the International Code for the Construction and Equipment of Ships Carrying Dangerous Chemicals in Bulk adopted by the Maritime Safety Committee of the Organization by resolution MSC.4(48), as may be amended by the Organization, provided that such amendments are adopted, brought into force and take effect in accordance with the provisions of article VIII of the present Convention concerning the amendment procedures applicable to the annex other than chapter I.
- 2 *Chemical tanker* means a cargo ship constructed or adapted and used for the carriage in bulk of any liquid product listed in chapter 17 of the International Bulk Chemical Code.
- 3 For the purpose of regulation 9, *ship constructed* means a ship the keel of which is laid or which is at a similar stage of construction.
- 4 *At a similar stage of construction* means the stage at which:
 - .1 construction identifiable with a specific ship begins; and
 - .2 assembly of that ship has commenced comprising at least 50 tonnes or 1% of the estimated mass of all structural material, whichever is less.

Regulation 9

Application to chemical tankers

- 1 Unless expressly provided otherwise, this part applies to chemical tankers constructed on or after 1 July 1986 including those of less than 500 gross tonnage. Such tankers shall comply with the requirements of this part in addition to any other applicable requirements of the present regulations.
- 2 Any chemical tanker, irrespective of the date of construction, which undergoes repairs, alterations, modifications and outfitting related thereto shall continue to comply with at least the requirements previously applicable to the ship. Such a ship, if constructed before 1 July 1986, shall, as a rule, comply with the requirements for a ship constructed on or after that date to at least the same extent as before undergoing such repairs, alterations, modifications or outfitting. Repairs, alterations and modifications of a major character, and outfitting related thereto, shall meet the requirements for a ship constructed on or after 1 July 1986 in so far as the Administration deems reasonable and practicable.
- 3 A ship, irrespective of the date of construction, which is converted to a chemical tanker shall be treated as a chemical tanker constructed on the date on which such conversion commenced.

Regulation 10

Requirements for chemical tankers

1 A chemical tanker shall comply with the requirements of the International Bulk Chemical Code and shall, in addition to the requirements of regulation I/8, I/9, and I/10, as applicable, be surveyed and certified as provided for in that Code.

2 A chemical tanker holding a certificate issued pursuant to the provisions of paragraph 1 shall be subject to the control established in regulation I/19. For this purpose such certificate shall be treated as a certificate issued under regulation I/12 or I/13..

Part C

Construction and equipment of ships carrying liquefied gases in bulk

Regulation 11

Definitions

For the purpose of this part, unless expressly provided otherwise:

- 1 *International Gas Carrier Code (IGC Code)* means the International Code for the Construction and Equipment of Ships Carrying Liquefied Gases in Bulk as adopted by the Maritime Safety Committee of the Organization by resolution MSC.5(48), as may be amended by the Organization, provided that such amendments are adopted, brought into force and take effect in accordance with the provisions of article VIII of the present Convention concerning the amendment procedures applicable to the annex other than chapter I.
- 2 *Gas carrier* means a cargo ship constructed or adapted and used for the carriage in bulk of any liquefied gas or other product listed in chapter 19 of the International Gas Carrier Code.
- 3 For the purpose of regulation 12, *ship constructed* means a ship the keel of which is laid or which is at a similar stage of construction.
- 4 *At a similar stage of construction* means the stage at which:
 - .1 construction identifiable with a specific ship begins; and
 - .2 assembly of that ship has commenced comprising at least 50 tonnes or 1% of the estimated mass of all structural material, whichever is less.

Regulation 12

Application to gas carriers

- 1 Unless expressly provided otherwise, this part applies to gas carriers constructed on or after 1 July 1986 including those of less than 500 gross tonnage. Such gas carriers shall comply with the requirements of this part in addition to any other applicable requirements of the present regulations.
- 2 Any gas carrier, irrespective of the date of construction, which undergoes repairs, alterations, modifications and outfitting related thereto shall continue to comply with at least the requirements previously applicable to the ship. Such a ship if constructed before 1 July 1986 shall, as a rule, comply with the requirements for a ship constructed on or after that date to at least the same extent as before undergoing such repairs, alterations, modifications or outfitting. Repairs, alterations and modifications of a major character, and outfitting related thereto, shall meet the requirements for a ship constructed on or after 1 July 1986 in so far as the Administration deems reasonable and practicable.
- 3 A ship, irrespective of the date of construction, which is converted to a gas carrier shall be treated as a gas carrier constructed on the date on which such conversion commenced.

Regulation 13

Requirements for gas carriers

1 A gas carrier shall comply with the requirements of the International Gas Carrier Code and shall, in addition to the requirements of regulation I/8, I/9 and I/10, as applicable, be surveyed and certified as provided for in that Code. For the purpose of this regulation, the requirements of the Code shall be treated as mandatory.

2 A gas carrier holding a certificate issued pursuant to the provisions of paragraph 1 shall be subject to the control established in regulation I/19. For this purpose such certificate shall be treated as a certificate issued under regulation I/12 or I/13.

Part D

Special requirements for the carriage of packaged irradiated nuclear fuel, plutonium and high-level radioactive wastes on board ships

Regulation 14

Definitions

For the purpose of this part, unless expressly provided otherwise:

- 1 *INF Code* means the International Code for the Safe Carriage of Packaged Irradiated Nuclear Fuel, Plutonium and High-Level Radioactive Wastes on Board Ships, adopted by the Maritime Safety Committee of the Organization by resolution MSC.88(71), as may be amended by the Organization, provided that such amendments are adopted, brought into force and take effect in accordance with the provisions of article VIII of the present Convention concerning the amendment procedures applicable to the annex other than chapter I.
- 2 *INF cargo* means packaged irradiated nuclear fuel, plutonium and high-level radioactive wastes carried as cargo in accordance with class 7 of the IMDG Code.
- 3 *Irradiated nuclear fuel* means material containing uranium, thorium and/or plutonium isotopes which has been used to maintain a self-sustaining nuclear chain reaction.
- 4 *Plutonium* means the resultant mixture of isotopes of that material extracted from irradiated nuclear fuel from reprocessing.
- 5 *High-level radioactive wastes* means liquid wastes resulting from the operation of the first stage extraction system or the concentrated wastes from subsequent extraction stages, in a facility for reprocessing irradiated nuclear fuel, or solids into which such liquid wastes have been converted.

Regulation 15

Application to ships carrying INF cargo

- 1 Except as provided for in paragraph 2, this part shall apply to all ships regardless of the date of construction and size, including cargo ships of less than 500 gross tonnage, engaged in the carriage of INF cargo.
- 2 This part and the INF Code do not apply to warships, naval auxiliary or other vessels owned or operated by a Contracting Government and used, for the time being, only on government non-commercial service; however, each Administration shall ensure, by the adoption of appropriate measures not impairing operations or operational capabilities of such ships owned or operated by it, that such ships carrying INF cargo act in a manner consistent, so far as reasonable and practicable, with this part and the INF Code.
- 3 Nothing in this part or the INF Code shall prejudice the rights and duties of governments under international law and any action taken to enforce compliance shall be consistent with international law.

Regulation 16

Requirements for ships carrying INF cargo

1 A ship carrying INF cargo shall comply with the requirements of the INF Code in addition to any other applicable requirements of the present regulations and shall be surveyed and certified as provided for in that Code.

2 A ship holding a certificate issued pursuant to the provisions of paragraph 1 shall be subject to the control established in regulations I/19 and XI-1/4. For this purpose, such certificate shall be treated as a certificate issued under regulation I/12 or I/13.

Chapter VIII

Nuclear ships

Chapter VIII

Nuclear ships

Regulation 1	Application	417
Regulation 2	Application of other chapters	417
Regulation 3	Exemptions	417
Regulation 4	Approval of reactor installation	417
Regulation 5	Suitability of reactor installation for service on board ship	417
Regulation 6	Radiation safety	417
Regulation 7	Safety assessment	417
Regulation 8	Operating manual	418
Regulation 9	Surveys	418
Regulation 10	Certificates	418
Regulation 11	Special control	418
Regulation 12	Casualties	419

Regulation 1

Application

This chapter applies to all nuclear ships except ships of war.

Regulation 2

Application of other chapters

The regulations contained in the other chapters of the present Convention apply to nuclear ships except as modified by this chapter.*

Regulation 3

Exemptions

A nuclear ship shall not, in any circumstances, be exempted from compliance with any regulations of this Convention.

Regulation 4

Approval of reactor installation

The design, construction and standards of inspection and assembly of the reactor installation shall be subject to the approval and satisfaction of the Administration and shall take account of the limitations which will be imposed on surveys by the presence of radiation.

Regulation 5

Suitability of reactor installation for service on board ship

The reactor installation shall be designed having regard to the special conditions of service on board ship both in normal and exceptional circumstances of navigation.

Regulation 6

Radiation safety

The Administration shall take measures to ensure that there are no unreasonable radiation or other nuclear hazards, at sea or in port, to the crew, passengers or public, or to the waterways or food or water resources.

Regulation 7

Safety assessment

(a) A safety assessment shall be prepared to permit evaluation of the nuclear power plant and safety of the ship to ensure that there are no unreasonable radiation or other hazards, at sea or in port, to the crew, passengers or public, or to the waterways or food or water resources. The Administration, when satisfied, shall approve such safety assessment which shall always be kept up to date.

* Refer to the *Code of Safety for Nuclear Merchant Ships* (resolution A.491(XII)), which supplements the requirements of this chapter.

(b) The safety assessment shall be made available sufficiently in advance to the Contracting Governments of the countries which a nuclear ship intends to visit so that they may evaluate the safety of the ship.

Regulation 8

Operating manual

A fully detailed operating manual shall be prepared for the information and guidance of the operating personnel in their duties on all matters relating to the operation of the nuclear power plant and having an important bearing on safety. The Administration, when satisfied, shall approve such operating manual and a copy shall be kept on board the ship. The operating manual shall always be kept up to date.

Regulation 9

Surveys

Survey of nuclear ships shall include the applicable requirements of regulation 7 of chapter I, or of regulations 8, 9 and 10 of chapter I, except in so far as surveys are limited by the presence of radiation. In addition, the surveys shall include any special requirements of the safety assessment. They shall in all cases, notwithstanding the provisions of regulations 8 and 10 of chapter I, be carried out not less frequently than once a year.

Regulation 10

Certificates

(a) The provisions of paragraph (a) of regulation 12 of chapter I and of regulation 14 of chapter I shall not apply to nuclear ships.

(b) A certificate, called a Nuclear Passenger Ship Safety Certificate shall be issued after inspection and survey to a nuclear passenger ship which complies with the requirements of chapters II-1, II-2, III, IV and VIII, and any other relevant requirements of the present regulations.

(c) A certificate, called a Nuclear Cargo Ship Safety Certificate shall be issued after inspection and survey to a nuclear cargo ship which satisfies the requirements for cargo ships on survey set out in regulation 10 of chapter I, and complies with the requirements of chapters II-1, II-2, III, IV and VIII and any other relevant requirements of the present regulations.

(d) Nuclear Passenger Ship Safety Certificates and Nuclear Cargo Ship Safety Certificates shall state: "That the ship, being a nuclear ship, complied with all requirements of chapter VIII of the Convention and conformed to the Safety Assessment approved for the ship".

(e) Nuclear Passenger Ship Safety Certificates and Nuclear Cargo Ship Safety Certificates shall be valid for a period of not more than 12 months.

(f) Nuclear Passenger Ship Safety Certificates and Nuclear Cargo Ship Safety Certificates shall be issued either by the Administration or by any person or organization duly authorized by it. In every case, that Administration assumes full responsibility for the certificate.

Regulation 11

*Special control**

In addition to the control established by regulation 19 of chapter I, nuclear ships shall be subject to special control before entering the ports and in the ports of Contracting Governments, directed towards verifying that

* Refer to the IMO/IAEA *Safety Recommendations on the Use of Ports by Nuclear Merchant Ships*.

there is on board a valid Nuclear Ship Safety Certificate and that there are no unreasonable radiation or other hazards at sea or in port, to the crew, passengers or public, or to the waterways or food or water resources.

Regulation 12

Casualties

In the event of any accident likely to lead to an environmental hazard the master of a nuclear ship shall immediately inform the Administration. The master shall also immediately inform the competent governmental authority of the country in whose waters the ship may be, or whose waters the ship approaches in a damaged condition.

Chapter IX

Management for the safe operation of ships

Chapter IX

Management for the safe operation of ships

Regulation 1	Definitions	425
Regulation 2	Application	425
Regulation 3	Safety management requirements	426
Regulation 4	Certification	426
Regulation 5	Maintenance of conditions.	426
Regulation 6	Verification and control	426

Regulation 1

Definitions

For the purpose of this chapter, unless expressly provided otherwise:

- 1 *International Safety Management (ISM) Code* means the International Management Code for the Safe Operation of Ships and for Pollution Prevention adopted by the Organization by resolution A.741(18), as may be amended by the Organization, provided that such amendments are adopted, brought into force and take effect in accordance with the provisions of article VIII of the present Convention concerning the amendment procedures applicable to the annex other than chapter I.
- 2 *Company* means the owner of the ship or any other organization or person such as the manager, or the bareboat charterer, who has assumed the responsibility for operation of the ship from the owner of the ship and who on assuming such responsibility has agreed to take over all the duties and responsibilities imposed by the International Safety Management Code.
- 3 *Oil tanker* means an oil tanker as defined in regulation II-1/2.22.
- 4 *Chemical tanker* means a chemical tanker as defined in regulation VII/8.2.
- 5 *Gas carrier* means a gas carrier as defined in regulation VII/11.2.
- 6 *Bulk carrier* means a ship which is constructed generally with single deck, top-side tanks and hopper side tanks in cargo spaces, and is intended primarily to carry dry cargo in bulk, and includes such types as ore carriers and combination carriers.*
- 7 *Mobile offshore drilling unit (MODU)* means a vessel capable of engaging in drilling operations for the exploration for or exploitation of resources beneath the sea-bed such as liquid or gaseous hydrocarbons, sulphur or salt.
- 8 *High-speed craft* means a craft as defined in regulation X/1.

Regulation 2

Application

- 1 This chapter applies to ships, regardless of the date of construction, as follows:
 - .1 passenger ships including passenger high-speed craft, not later than 1 July 1998;
 - .2 oil tankers, chemical tankers, gas carriers, bulk carriers and cargo high-speed craft of 500 gross tonnage and upwards, not later than 1 July 1998; and
 - .3 other cargo ships and mobile offshore drilling units of 500 gross tonnage and upwards, not later than 1 July 2002.†
- 2 This chapter does not apply to government-operated ships used for non-commercial purposes.

* Refer to *Interpretation of the provisions of SOLAS chapter XII on additional safety measures for bulk carriers* (resolution MSC.79(70)) and *Clarification of the term "bulk carrier" and guidance for application of regulations in SOLAS to ships which occasionally carry dry cargoes in bulk and are not determined as bulk carriers in accordance with regulation XII/1.1 and chapter II-1* (resolution MSC.277(85)).

† The Maritime Safety Committee, at its sixty-sixth session, decided that mobile offshore drilling units not propelled by mechanical means need not comply with the requirements of the chapter.

Regulation 3

*Safety management requirements**

- 1 The company and the ship shall comply with the requirements of the International Safety Management Code. For the purpose of this regulation, the requirements of the Code shall be treated as mandatory.
- 2 The ship shall be operated by a company holding a Document of Compliance referred to in regulation 4.

Regulation 4

Certification†

- 1 A Document of Compliance shall be issued to every company which complies with the requirements of the International Safety Management Code. This document shall be issued by the Administration, by an organization recognized by the Administration‡, or at the request of the Administration by another Contracting Government.
- 2 A copy of the Document of Compliance shall be kept on board the ship in order that the master can produce it on request for verification.
- 3 A Certificate, called a Safety Management Certificate, shall be issued to every ship by the Administration or an organization recognized by the Administration. The Administration or organization recognized by it shall, before issuing the Safety Management Certificate, verify that the company and its shipboard management operate in accordance with the approved safety management system.

Regulation 5

Maintenance of conditions

The safety management system shall be maintained in accordance with the provisions of the International Safety Management Code.

Regulation 6

Verification and control§

- 1 The Administration, another Contracting Government at the request of the Administration or an organization recognized by the Administration shall periodically verify the proper functioning of the ship's safety management system.
- 2 A ship required to hold a certificate issued pursuant to the provisions of regulation 4.3 shall be subject to control in accordance with the provisions of regulation XI/4. For this purpose such certificate shall be treated as a certificate issued under regulation I/12 or I/13.

* Refer to *Revised guidelines for the operational implementation of the ISM Code by Companies (MSC-MEPC.7/Circ.8)*; *Implementation of the ISM Code – Guidance to companies operating multi-flagged fleets and supplementary guidelines to Administrations (MSC/Circ.762)*.

† Refer to *Unified interpretation of the date of completion of the survey and verification on which the certificates are based (MSC-MEPC.5/Circ.3)* and *Unified interpretation on the expiration date of statutory certificates (MSC-MEPC.5/Circ.13)*.

‡ Refer to the *Code for Recognized Organizations (RO Code) (MSC.349(92) and MEPC.237(65))*; *Communication of information on the authorization of recognized organizations (ROs) (MSC/Circ.1010-MEPC/Circ.382)* and the information collected via the Global Integrated Shipping Information System (GISIS).

§ Refer to *Revised guidelines on implementation of the International Safety Management (ISM) Code by Administrations (resolution A.1118(30))*, *Procedures for port State control, 2019 (resolution A.1138(31))*; *Procedures concerning observed ISM Code major non-conformities (MSC/Circ.1059-MEPC/Circ.401)* and *IMO requirements on carriage of publications on board ships (MSC-MEPC.2/Circ.2)*.

Chapter X

Safety measures for high-speed craft

X

Chapter X

Safety measures for high-speed craft

Regulation 1	Definitions.	431
Regulation 2	Application	431
Regulation 3	Requirements for high-speed craft	432



X

Regulation 1

Definitions

For the purpose of this chapter:

1 *High-Speed Craft Code, 1994 (1994 HSC Code)* means the International Code of Safety for High-Speed Craft adopted by the Maritime Safety Committee of the Organization by resolution MSC.36(63), as may be amended by the Organization, provided that such amendments are adopted, brought into force and take effect in accordance with the provisions of article VIII of the present Convention concerning the amendment procedures applicable to the annex other than chapter I.

2 *High-Speed Craft Code, 2000 (2000 HSC Code)* means the International Code of Safety for High-Speed Craft, 2000, adopted by the Maritime Safety Committee of the Organization by resolution MSC.97(73), as may be amended by the Organization, provided that such amendments are adopted, brought into force and take effect in accordance with the provisions of article VIII of the present Convention concerning the amendment procedures applicable to the annex other than chapter I.

3 *High-speed craft* is a craft capable of a maximum speed, in metres per second (m/s), equal to or exceeding:

$$3.7 \nabla^{0.1667}$$

where: ∇ = volume of displacement corresponding to the design waterline (m³),

excluding craft the hull of which is supported completely clear above the water surface in non-displacement mode by aerodynamic forces generated by ground effect.

4 *Craft constructed* means a craft the keel of which is laid or which is at a similar stage of construction.

5 *Similar stage of construction* means a stage at which:

- .1 construction identifiable with a specific craft begins; and
- .2 assembly of that craft has commenced comprising at least 50 tonnes or 3% of the estimated mass of all structural material, whichever is less.

Regulation 2

Application

1 This chapter applies to high-speed craft constructed on or after 1 January 1996, as follows:

- .1 passenger craft which do not proceed in the course of their voyage more than 4 h at operational speed from a place of refuge when fully laden; and
- .2 cargo craft of 500 gross tonnage and upwards which do not proceed in the course of their voyage more than 8 h at operational speed from a place of refuge when fully laden.

2 Any craft, irrespective of the date of construction, which undergoes repairs, alterations, modifications and outfitting related thereto shall continue to comply with at least the requirements previously applicable to the craft. Such a craft, if constructed before 1 July 2002, shall, as a rule, comply with the requirements for a craft constructed on or after that date to at least the same extent as it did before undergoing such repairs, alterations, modifications or outfitting. Repairs, alterations and modifications of a major character, and outfitting related thereto, shall meet the requirements for a craft constructed on or after 1 July 2002 in so far as the Administration deems reasonable and practicable.

Regulation 3 *Requirements for high-speed craft*

- 1 Notwithstanding the provisions of chapters I to IV and regulations V/18, 19 and 20:
 - .1 a high-speed craft constructed on or after 1 January 1996 but before 1 July 2002 which complies with the requirements of the High-Speed Craft Code, 1994 in its entirety and which has been surveyed and certified as provided in that Code shall be deemed to have complied with the requirements of chapters I to IV and regulations V/18, 19 and 20. For the purpose of this regulation, the requirements of that Code shall be treated as mandatory;
 - .2 a high-speed craft constructed on or after 1 July 2002 which complies with the requirements of the High-Speed Craft Code, 2000 in its entirety and which has been surveyed and certified as provided in that Code shall be deemed to have complied with the requirements of chapters I to IV and regulations V/18, 19 and 20.
- 2 The certificates and permits issued under the High-Speed Craft Code shall have the same force and the same recognition as the certificates issued under chapter I.

Chapter XI-1

Special measures to enhance
maritime safety

Chapter XI-1

Special measures to enhance maritime safety

Regulation 1	Authorization of recognized organizations	437
Regulation 2	Enhanced surveys	437
Regulation 2-1	Harmonization of survey periods of cargo ships not subject to the ESP Code.	437
Regulation 3	Ship identification number.	437
Regulation 3-1	Company and registered owner identification number	438
Regulation 4	Port State control on operational requirements.	439
Regulation 5	Continuous Synopsis Record	439
Regulation 6	Additional requirements for the investigation of marine casualties and incidents.	441
Regulation 7	Atmosphere testing instrument for enclosed spaces	441
Unified Interpretations for Chapter XI-1		443

XI-1

Regulation 1

*Authorization of recognized organizations**

The Administration shall authorize organizations, referred to in regulation I/6, including classification societies, in accordance with the provisions of the present Convention and with the Code for Recognized Organizations (RO Code), consisting of part 1 and part 2 (the provisions of which shall be treated as mandatory) and part 3 (the provisions of which shall be treated as recommendatory), as adopted by the Organization by resolution MSC.349(92), as may be amended by the Organization, provided that:

- .1 amendments to part 1 and part 2 of the RO Code are adopted, brought into force and take effect in accordance with the provisions of article VIII of the present Convention;
- .2 amendments to part 3 of the RO Code are adopted by the Maritime Safety Committee in accordance with its Rules of Procedure; and
- .3 any amendments adopted by the Maritime Safety Committee and the Marine Environment Protection Committee are identical and come into force or take effect at the same time, as appropriate.

Regulation 2

Enhanced surveys†

Bulk carriers as defined in regulation IX/1.6 and oil tankers as defined in regulation II-1/2.22 shall be subject to an enhanced programme of inspections in accordance with the International Code on the Enhanced Programme of Inspections during Surveys of Bulk Carriers and Oil Tankers, 2011 (2011 ESP Code), adopted by the Assembly of the Organization by resolution A.1049(27), as may be amended by the Organization, provided that such amendments are adopted, brought into force and take effect in accordance with the provisions of article VIII of the present Convention concerning the amendment procedures applicable to the annex other than chapter I.

Regulation 2-1

Harmonization of survey periods of cargo ships not subject to the ESP Code

For cargo ships not subject to enhanced surveys under regulation XI-1/2, notwithstanding any other provisions, the intermediate and renewal surveys included in regulation I/10 may be carried out and completed over the corresponding periods as specified in the 2011 ESP Code, as may be amended, and the guidelines developed by the Organization,‡ as appropriate.

Regulation 3

Ship identification number

(Paragraphs 4 and 5 apply to all ships to which this regulation applies. For ships constructed before 1 July 2004, the requirements of paragraphs 4 and 5 shall be complied with not later than the first scheduled dry-docking of the ship after 1 July 2004)

* Refer to *IMO Instruments Implementation Code (III Code)* (resolution A.1070(28)); *Model agreement for the authorization of recognized organizations acting on behalf of the Administration* (MSC/Circ.710-MEPC/Circ.307, as may be amended); *Communication of information on the authorization of recognized organizations (ROs)* (MSC/Circ.1010-MEPC/Circ.382); *Guidelines for Administrations to ensure the adequacy of transfer of class-related matters between Recognized Organizations (ROs)* (MSC-MEPC.5/Circ.2); and *Notification and circulation through the Global Integrated Shipping Information System (GISIS)* (resolution A.1074(28)).

† Refer to *Guidance for planning the enhanced programme of inspections during surveys of bulk carriers and oil tankers* (MSC/Circ.655) and *Guidelines on the means of access to structures for inspection and maintenance of oil tankers and bulk carriers* (MSC/Circ.686/Rev.1).

‡ Refer to the *Survey guidelines under the Harmonized System of Survey and Certification (HSSC), 2019* (resolution A.1140(31), as may be amended).

- 1 This regulation applies to all passenger ships of 100 gross tonnage and upwards and to all cargo ships of 300 gross tonnage and upwards.
- 2 Every ship shall be provided with an identification number which conforms to the IMO ship identification number scheme adopted by the Organization.*
- 3 The ship's identification number shall be inserted† on the certificates and certified copies thereof issued under regulation I/12 or regulation I/13.
- 4 The ship's identification number shall be permanently marked:
 - .1 in a visible place either on the stern of the ship or on either side of the hull, amidships port and starboard, above the deepest assigned load line or either side of the superstructure, port and starboard or on the front of the superstructure or, in the case of passenger ships, on a horizontal surface visible from the air; and
 - .2 in an easily accessible place either on one of the end transverse bulkheads of the machinery spaces, as defined in regulation II-2/3.30, or on one of the hatchways or, in the case of tankers, in the pump-room or, in the case of ships with ro-ro spaces, as defined in regulation II-2/3.41, on one of the end transverse bulkheads of the ro-ro spaces.
- 5.1 The permanent marking shall be plainly visible, clear of any other markings on the hull and shall be painted in a contrasting colour.
- 5.2 The permanent marking referred to in paragraph 4.1 shall be not less than 200 mm in height. The permanent marking referred to in paragraph 4.2 shall not be less than 100 mm in height. The width of the marks shall be proportionate to the height.
- 5.3 The permanent marking may be made by raised lettering or by cutting it in or by centre-punching it or by any other equivalent method of marking the ship identification number which ensures that the marking is not easily expunged.
- 5.4 On ships constructed of material other than steel or metal, the Administration shall approve the method of marking the ship identification number.

Regulation 3-1

Company and registered owner identification number

- 1 This regulation applies to Companies and registered owners of ships to which chapter I applies.
- 2 For the purpose of this regulation, registered owner shall be as specified by the Administration and Company as defined in regulation IX/I.
- 3 Every Company and registered owner shall be provided with an identification number which conforms to the IMO Unique Company and Registered Owner Identification Number Scheme adopted by the Organization.‡
- 4 The Company identification number shall be inserted on the certificates and certified copies thereof issued under regulation IX/4 and section A/19.2 or A/19.4 of the ISPS Code.
- 5 This regulation shall take effect when the certificates referred to in paragraph 4 are issued or renewed on or after 1 January 2009.

* Refer to the *IMO ship identification number scheme* (resolution A.1117(30)) and *Implementation of resolution A.1078(28) – IMO ship identification number scheme* (Circular letter No.1886/Rev.6), as may be amended.

† Refer to *Marking the ship's plans, manuals and other documents with the IMO ship identification number* (MSC/Circ.1142-MEPC/Circ.425).

‡ Refer to *Adoption of the IMO unique company and registered owner identification number scheme* (resolution MSC.160(78)) and *Implementation of IMO unique company and registered owner identification number scheme* (resolution MSC.160(78)) (Circular Letter No.2554/Rev.3), as may be amended.

Regulation 4

*Port State control on operational requirements**

- 1 A ship when in a port of another Contracting Government is subject to control by officers duly authorized by such Government concerning operational requirements in respect of the safety of ships, when there are clear grounds for believing that the master or crew are not familiar with essential shipboard procedures relating to the safety of ships.
- 2 In the circumstances defined in paragraph 1 of this regulation, the Contracting Government carrying out the control shall take such steps as will ensure that the ship shall not sail until the situation has been brought to order in accordance with the requirements of the present Convention.
- 3 Procedures relating to the port State control prescribed in regulation I/19 shall apply to this regulation.
- 4 Nothing in the present regulation shall be construed to limit the rights and obligations of a Contracting Government carrying out control over operational requirements specifically provided for in the regulations.

Regulation 5

Continuous Synopsis Record

- 1 Every ship to which chapter I applies shall be issued with a Continuous Synopsis Record.
- 2.1 The Continuous Synopsis Record is intended to provide an on-board record of the history of the ship with respect to the information recorded therein.
- 2.2 For ships constructed before 1 July 2004, the Continuous Synopsis Record shall, at least, provide the history of the ship as from 1 July 2004.
- 3 The Continuous Synopsis Record shall be issued by the Administration to each ship that is entitled to fly its flag and it shall contain, at least, the following information (the Continuous Synopsis Record shall contain the information in paragraphs 3.7 and 3.10 when it is issued or updated on or after 1 January 2009):
 - .1 the name of the State whose flag the ship is entitled to fly;
 - .2 the date on which the ship was registered with that State;
 - .3 the ship's identification number in accordance with regulation 3;
 - .4 the name of the ship;
 - .5 the port at which the ship is registered;
 - .6 the name of the registered owner(s) and their registered address(es);
 - .7 the registered owner identification number;
 - .8 the name of the registered bareboat charterer(s) and their registered address(es), if applicable;
 - .9 the name of the Company, as defined in regulation IX/1, its registered address and the address(es) from where it carries out the safety management activities;
 - .10 the Company identification number;
 - .11 the name of all classification society(ies) with which the ship is classed;
 - .12 the name of the Administration or of the Contracting Government or of the recognized organization which has issued the Document of Compliance (or the Interim Document of Compliance), specified in the ISM Code as defined in regulation IX/1, to the Company operating the ship and the name of the body which has carried out the audit on the basis of which the Document was issued, if other than that issuing the Document;

* Refer to *Procedures for port State control, 2019* (resolution A.1138(31)).

- .13 the name of the Administration or of the Contracting Government or of the recognized organization that has issued the Safety Management Certificate (or the Interim Safety Management Certificate), specified in the ISM Code as defined in regulation IX/1, to the ship and the name of the body which has carried out the audit on the basis of which the Certificate was issued, if other than that issuing the Certificate;
- .14 the name of the Administration or of the Contracting Government or of the recognized security organization that has issued the International Ship Security Certificate (or the Interim International Ship Security Certificate), specified in part A of the ISPS Code as defined in regulation XI-2/1, to the ship and the name of the body which has carried out the verification on the basis of which the Certificate was issued, if other than that issuing the Certificate; and
- .15 the date on which the ship ceased to be registered with that State.

4.1 Any changes relating to the entries referred to in paragraphs 3.4 to 3.12 shall be recorded in the Continuous Synopsis Record so as to provide updated and current information together with the history of the changes.

4.2 In case of any changes relating to the entries referred to in paragraph 4.1, the Administration shall issue, as soon as is practically possible but not later than three months from the date of the change, to the ships entitled to fly its flag either a revised and updated version of the Continuous Synopsis Record or appropriate amendments thereto.

4.3 In case of any changes relating to the entries referred to in paragraph 4.1, the Administration, pending the issue of a revised and updated version of the Continuous Synopsis Record, shall authorize and require either the Company as defined in regulation IX/1 or the master of the ship to amend the Continuous Synopsis Record to reflect the changes. In such cases, after the Continuous Synopsis Record has been amended, the Company shall, without delay, inform the Administration accordingly.

5.1 The Continuous Synopsis Record shall be in English, French or Spanish language. Additionally, a translation of the Continuous Synopsis Record into the official language or languages of the Administration may be provided.

5.2 The Continuous Synopsis Record shall be in the format developed by the Organization and shall be maintained in accordance with guidelines developed by the Organization.* Any previous entries in the Continuous Synopsis Record shall not be modified, deleted or, in any way, erased or defaced.

6 Whenever a ship is transferred to the flag of another State or the ship is sold to another owner (or is taken over by another bareboat charterer) or another Company assumes the responsibility for the operation of the ship, the Continuous Synopsis Record shall be left on board.

7 When a ship is to be transferred to the flag of another State, the Company shall notify the Administration of the name of the State under whose flag the ship is to be transferred so as to enable the Administration to forward to that State a copy of the Continuous Synopsis Record covering the period during which the ship was under its jurisdiction.

8 When a ship is transferred to the flag of another State the Government of which is a Contracting Government, the Contracting Government of the State whose flag the ship was flying hitherto shall transmit to the Administration, as soon as possible after the transfer takes place, a copy of the relevant Continuous Synopsis Record covering the period during which the ship was under their jurisdiction together with any Continuous Synopsis Records previously issued to the ship by other States.

9 When a ship is transferred to the flag of another State, the Administration shall append the previous Continuous Synopsis Records to the Continuous Synopsis Record the Administration will issue to the ship so to provide the continuous history record intended by this regulation.

10 The Continuous Synopsis Record shall be kept on board the ship and shall be available for inspection at all times.

* Refer to *Format and guidelines for the maintenance of the Continuous Synopsis Record (CSR)* (resolution A.959(23), as amended by MSC.198(80)) and *Guidance to port State control officers on the non-security related elements of the 2002 SOLAS amendments* (MSC/Circ.1113).

Regulation 6*Additional requirements for the investigation of marine casualties and incidents**

Taking into account regulation I/21, each Administration shall conduct investigations of marine casualties and incidents, in accordance with the provisions of the present Convention, as supplemented by the provisions of the Code of the International Standards and Recommended Practices for a Safety Investigation into a Marine Casualty or Marine Incident (Casualty Investigation Code) adopted by resolution MSC.255(84), and:

- .1 the provisions of parts I and II of the Casualty Investigation Code shall be fully complied with;
- .2 the related guidance and explanatory material contained in part III of the Casualty Investigation Code should be taken into account to the greatest possible extent in order to achieve a more uniform implementation of the Casualty Investigation Code;
- .3 amendments to parts I and II of the Casualty Investigation Code shall be adopted, brought into force and take effect in accordance with the provisions of article VIII of the present Convention concerning the amendment procedures applicable to the annex other than chapter I; and
- .4 part III of the Casualty Investigation Code shall be amended by the Maritime Safety Committee in accordance with its rules of procedure.

Regulation 7*Atmosphere testing instrument for enclosed spaces*

SEE INTERPRETATION 1

Every ship to which chapter I applies shall carry an appropriate portable atmosphere testing instrument or instruments[†]. As a minimum, these shall be capable of measuring concentrations of oxygen, flammable gases or vapours, hydrogen sulphide and carbon monoxide prior to entry into enclosed spaces[‡]. Instruments carried under other requirements may satisfy this regulation. Suitable means shall be provided for the calibration of all such instruments.

* Refer to the following resolutions:

IMO Instruments Implementation Code (III Code) (resolution A.1070(28));

Guidelines to assist investigators in the implementation of the Casualty Investigation Code (resolution MSC.255(84)) (resolution A.1075(28));

Recommendation on the conclusion of agreements and arrangements between States on the question of access and employment of foreign seaborne salvage equipment in territorial waters (resolution A.203(VII));

Guidelines on fair treatment of seafarers in the event of a maritime accident (resolution A.987(24));

Promotion as widely as possible of the application of the 2006 guidelines on fair treatment of seafarers in the event of a maritime accident (resolution A.1056(27)); and

Notification and circulation through the Global Integrated Shipping Information System (GISIS) (resolution A.1074(28)).

Refer also to:

Revised harmonized reporting procedures – Reports required under SOLAS regulations I/21 and XI-1/6, and MARPOL, articles 8 and 12 (MSC-MEPC.3/Circ.4/Rev.1);

Provision of preliminary information on serious and very serious casualties by rescue coordination centres (MSC/Circ.802-MEPC/Circ.332);

Guidance on near-miss reporting (MSC-MEPC.7/Circ.7); and

Reporting near misses (MSC.Circ.1015).

[†] Refer to the *Guidelines to facilitate the selection of portable atmosphere testing instruments for enclosed spaces as required by SOLAS regulation XI-1/7* (MSC.1/Circ.1477).

[‡] Refer to the *Revised recommendations for entering enclosed spaces aboard ships* (resolution A.1050(27)).

XI-1

Unified Interpretations for Chapter XI-1

1 Provision of suitable means for the calibration of portable atmosphere testing instruments *(Source: MSC.1/Circ.1561)*

Reg. 7

1.1 Compliance with the provision "suitable means shall be provided for the calibration of all such instruments" in SOLAS regulation XI-1/7, as adopted by resolution MSC.380(94), may be achieved by portable atmosphere testing instruments being calibrated on board or ashore in accordance with the manufacturer's instructions.

1.2 For the avoidance of any doubt, the above clarification refers to the calibration of portable atmosphere testing instruments, as required by SOLAS regulation XI-1/7, and not to any pre-operational accuracy tests as recommended by the manufacturer.

Chapter XI-2

Special measures to enhance
maritime security

Chapter XI-2

Special measures to enhance maritime security

Regulation 1	Definitions	449
Regulation 2	Application	450
Regulation 3	Obligations of Contracting Governments with respect to security	450
Regulation 4	Requirements for Companies and ships	451
Regulation 5	Specific responsibility of Companies	451
Regulation 6	Ship security alert system	451
Regulation 7	Threats to ships	452
Regulation 8	Master's discretion for ship safety and security	452
Regulation 9	Control and compliance measures	453
Regulation 10	Requirements for port facilities	455
Regulation 11	Alternative security agreements	455
Regulation 12	Equivalent security arrangements	455
Regulation 13	Communication of information	456

Regulation 1

Definitions

- 1 For the purpose of this chapter, unless expressly provided otherwise:
 - .1 *Bulk carrier* means a bulk carrier as defined in regulation IX/1.6.
 - .2 *Chemical tanker* means a chemical tanker as defined in regulation VII/8.2.
 - .3 *Gas carrier* means a gas carrier as defined in regulation VII/11.2.
 - .4 *High-speed craft* means a craft as defined in regulation X/1.2.
 - .5 *Mobile offshore drilling unit* means a mechanically propelled mobile offshore drilling unit, as defined in regulation IX/1.7, not on location.
 - .6 *Oil tanker* means an oil tanker as defined in regulation II-1/2.22.
 - .7 *Company* means a Company as defined in regulation IX/1.2.
 - .8 *Ship/port interface* means the interactions that occur when a ship is directly and immediately affected by actions involving the movement of persons, goods or the provisions of port services to or from the ship.
 - .9 *Port facility* is a location, as determined by the Contracting Government or by the Designated Authority, where the ship/port interface takes place. This includes areas such as anchorages, waiting berths and approaches from seaward, as appropriate.
 - .10 *Ship-to-ship activity* means any activity not related to a port facility that involves the transfer of goods or persons from one ship to another.
 - .11 *Designated Authority* means the organization(s) or the administration(s) identified, within the Contracting Government, as responsible for ensuring the implementation of the provisions of this chapter pertaining to port facility security and ship/port interface, from the point of view of the port facility.
 - .12 *International Ship and Port Facility Security (ISPS) Code* means the International Code for the Security of Ships and of Port Facilities consisting of part A (the provisions of which shall be treated as mandatory) and part B (the provisions of which shall be treated as recommendatory), as adopted, on 12 December 2002, by resolution 2 of the Conference of Contracting Governments to the International Convention for the Safety of Life at Sea, 1974 as may be amended by the Organization, provided that:
 - .1 amendments to part A of the Code are adopted, brought into force and take effect in accordance with article VIII of the present Convention concerning the amendment procedures applicable to the annex other than chapter I; and
 - .2 amendments to part B of the Code are adopted by the Maritime Safety Committee in accordance with its Rules of Procedure.
 - .13 *Security incident* means any suspicious act or circumstance threatening the security of a ship, including a mobile offshore drilling unit and a high-speed craft, or of a port facility or of any ship/port interface or any ship-to-ship activity.
 - .14 *Security level* means the qualification of the degree of risk that a security incident will be attempted or will occur.
 - .15 *Declaration of Security* means an agreement reached between a ship and either a port facility or another ship with which it interfaces, specifying the security measures each will implement.

.16 *Recognized security organization* means an organization with appropriate expertise in security matters and with appropriate knowledge of ship and port operations authorized to carry out an assessment, or a verification, or an approval or a certification activity, required by this chapter or by part A of the ISPS Code.

2 The term *ship*, when used in regulations 3 to 13, includes mobile offshore drilling units and high-speed craft.

3 The term *all ships*, when used in this chapter, means any ship to which this chapter applies.

4 The term *Contracting Government*, when used in regulations 3, 4, 7 and 10 to 13, includes a reference to the Designated Authority.

Regulation 2

Application

1 This chapter applies to:

.1 the following types of ships engaged on international voyages:

.1 passenger ships, including high-speed passenger craft;

.2 cargo ships, including high-speed craft, of 500 gross tonnage and upwards; and

.3 mobile offshore drilling units; and

.2 port facilities serving such ships engaged on international voyages.

2 Notwithstanding the provisions of paragraph 1.2, Contracting Governments shall decide the extent of application of this chapter and of the relevant sections of part A of the ISPS Code to those port facilities within their territory which, although used primarily by ships not engaged on international voyages, are required, occasionally, to serve ships arriving or departing on an international voyage.

2.1 Contracting Governments shall base their decisions, under paragraph 2, on a port facility security assessment carried out in accordance with the provisions of part A of the ISPS Code.

2.2 Any decision which a Contracting Government makes, under paragraph 2, shall not compromise the level of security intended to be achieved by this chapter or by part A of the ISPS Code.

3 This chapter does not apply to warships, naval auxiliaries or other ships owned or operated by a Contracting Government and used only on government non-commercial service.

4 Nothing in this chapter shall prejudice the rights or obligations of States under international law.

Regulation 3

Obligations of Contracting Governments with respect to security

1 Administrations shall set security levels and ensure the provision of security-level information to ships entitled to fly their flag. When changes in security level occur, security-level information shall be updated as the circumstance dictates.

2 Contracting Governments shall set security levels and ensure the provision of security-level information to port facilities within their territory, and to ships prior to entering a port or whilst in a port within their territory. When changes in security level occur, security-level information shall be updated as the circumstance dictates.

Regulation 4

Requirements for Companies and ships

- 1 Companies shall comply with the relevant requirements of this chapter and of part A of the ISPS Code, taking into account the guidance given in part B of the ISPS Code.
- 2 Ships shall comply with the relevant requirements of this chapter and of part A of the ISPS Code, taking into account the guidance given in part B of the ISPS Code, and such compliance shall be verified and certified as provided for in part A of the ISPS Code.
- 3 Prior to entering a port or whilst in a port within the territory of a Contracting Government, a ship shall comply with the requirements for the security level set by that Contracting Government, if such security level is higher than the security level set by the Administration for that ship.
- 4 Ships shall respond without undue delay to any change to a higher security level.
- 5 Where a ship is not in compliance with the requirements of this chapter or of part A of the ISPS Code, or cannot comply with the requirements of the security level set by the Administration or by another Contracting Government and applicable to that ship, then the ship shall notify the appropriate competent authority prior to conducting any ship/port interface or prior to entry into port, whichever occurs earlier.

Regulation 5

Specific responsibility of Companies

The Company shall ensure that the master has available on board, at all times, information through which officers duly authorized by a Contracting Government can establish:

- .1 who is responsible for appointing the members of the crew or other persons currently employed or engaged on board the ship in any capacity on the business of that ship;
- .2 who is responsible for deciding the employment of the ship; and
- .3 in cases where the ship is employed under the terms of charter party(ies), who are the parties to such charter party(ies).

Regulation 6

*Ship security alert system**

- 1 All ships shall be provided with a ship security alert system, as follows:
 - .1 ships constructed on or after 1 July 2004;
 - .2 passenger ships, including high-speed passenger craft, constructed before 1 July 2004, not later than the first survey of the radio installation after 1 July 2004;
 - .3 oil tankers, chemical tankers, gas carriers, bulk carriers and cargo high-speed craft, of 500 gross tonnage and upwards constructed before 1 July 2004, not later than the first survey of the radio installation after 1 July 2004; and
 - .4 other cargo ships of 500 gross tonnage and upward and mobile offshore drilling units constructed before 1 July 2004, not later than the first survey of the radio installation after 1 July 2006.
- 2 The ship security alert system, when activated, shall:
 - .1 initiate and transmit a ship-to-shore security alert to a competent authority designated by the Administration, which in these circumstances may include the Company, identifying the ship, its location and indicating that the security of the ship is under threat or it has been compromised;

* Refer to *Performance standards for a ship security alert system* (resolution MSC.136(76)) and *Revised performance standards for ship security alert systems* (resolution MSC.147(77)).

- .2 not send the ship security alert to any other ships;
 - .3 not raise any alarm on board the ship; and
 - .4 continue the ship security alert until deactivated and/or reset.
- 3 The ship security alert system shall:
- .1 be capable of being activated from the navigation bridge and in at least one other location; and
 - .2 conform to performance standards not inferior to those adopted by the Organization.
- 4 The ship security alert system activation points shall be designed so as to prevent the inadvertent initiation of the ship security alert.
- 5 The requirement for a ship security alert system may be complied with by using the radio installation fitted for compliance with the requirements of chapter IV, provided all requirements of this regulation are complied with.
- 6 When an Administration receives notification of a ship security alert, that Administration shall immediately notify the State(s) in the vicinity of which the ship is presently operating.
- 7 When a Contracting Government receives notification of a ship security alert from a ship which is not entitled to fly its flag, that Contracting Government shall immediately notify the relevant Administration and, if appropriate, the State(s) in the vicinity of which the ship is presently operating.

Regulation 7

Threats to ships

- 1 Contracting Governments shall set security levels and ensure the provision of security-level information to ships operating in their territorial sea or having communicated an intention to enter their territorial sea.
- 2 Contracting Governments shall provide a point of contact through which such ships can request advice or assistance and to which such ships can report any security concerns about other ships, movements or communications.
- 3 Where a risk of attack has been identified, the Contracting Government concerned shall advise the ships concerned and their Administrations of:
 - .1 the current security level;
 - .2 any security measures that should be put in place by the ships concerned to protect themselves from attack, in accordance with the provisions of part A of the ISPS Code; and
 - .3 security measures that the coastal State has decided to put in place, as appropriate.

Regulation 8

Master's discretion for ship safety and security

- 1 The master shall not be constrained by the Company, the charterer or any other person from taking or executing any decision which, in the professional judgement of the master, is necessary to maintain the safety and security of the ship. This includes denial of access to persons (except those identified as duly authorized by a Contracting Government) or their effects and refusal to load cargo, including containers or other closed cargo transport units.
- 2 If, in the professional judgement of the master, a conflict between any safety and security requirements applicable to the ship arises during its operations, the master shall give effect to those requirements necessary to maintain the safety of the ship. In such cases, the master may implement temporary security measures and shall forthwith inform the Administration and, if appropriate, the Contracting Government in whose port the ship is operating or intends to enter. Any such temporary security measures under this regulation shall, to the highest possible degree, be commensurate with the prevailing security level. When such cases are identified, the Administration shall ensure that such conflicts are resolved and that the possibility of recurrence is minimized.

Regulation 9*Control and compliance measures***1 Control of ships in port**

1.1 For the purpose of this chapter, every ship to which this chapter applies is subject to control when in a port of another Contracting Government by officers duly authorized by that Government, who may be the same as those carrying out the functions of regulation 1/19. Such control shall be limited to verifying that there is on board a valid International Ship Security Certificate or a valid Interim International Ship Security Certificate issued under the provisions of part A of the ISPS Code ("Certificate"), which if valid shall be accepted, unless there are clear grounds for believing that the ship is not in compliance with the requirements of this chapter or part A of the ISPS Code.

1.2 When there are such clear grounds, or when no valid Certificate is produced when required, the officers duly authorized by the Contracting Government shall impose any one or more control measures in relation to that ship as provided in paragraph 1.3. Any such measures imposed must be proportionate, taking into account the guidance given in part B of the ISPS Code.

1.3 Such control measures are as follows: inspection of the ship, delaying the ship, detention of the ship, restriction of operations, including movement within the port, or expulsion of the ship from port. Such control measures may additionally or alternatively include other lesser administrative or corrective measures.

2 Ships intending to enter a port of another Contracting Government

2.1 For the purpose of this chapter, a Contracting Government may require that ships intending to enter its ports provide the following information to officers duly authorized by that Government to ensure compliance with this chapter prior to entry into port with the aim of avoiding the need to impose control measures or steps:

- .1 that the ship possesses a valid Certificate and the name of its issuing authority;
- .2 the security level at which the ship is currently operating;
- .3 the security level at which the ship operated in any previous port where it has conducted a ship/port interface within the timeframe specified in paragraph 2.3;
- .4 any special or additional security measures that were taken by the ship in any previous port where it has conducted a ship/port interface within the timeframe specified in paragraph 2.3;
- .5 that the appropriate ship security procedures were maintained during any ship-to-ship activity within the timeframe specified in paragraph 2.3; or
- .6 other practical security-related information (but not details of the ship security plan), taking into account the guidance given in part B of the ISPS Code.

If requested by the Contracting Government, the ship or the Company shall provide confirmation, acceptable to that Contracting Government, of the information required above.

2.2 Every ship to which this chapter applies intending to enter the port of another Contracting Government shall provide the information described in paragraph 2.1 on the request of the officers duly authorized by that Government. The master may decline to provide such information on the understanding that failure to do so may result in denial of entry into port.

2.3 The ship shall keep records of the information referred to in paragraph 2.1 for the last 10 calls at port facilities.

2.4 If, after receipt of the information described in paragraph 2.1, officers duly authorized by the Contracting Government of the port in which the ship intends to enter have clear grounds for believing that the ship is in non-compliance with the requirements of this chapter or part A of the ISPS Code, such officers shall attempt to establish communication with and between the ship and the Administration in order to rectify the

non-compliance. If such communication does not result in rectification, or if such officers have clear grounds otherwise for believing that the ship is in non-compliance with the requirements of this chapter or part A of the ISPS Code, such officers may take steps in relation to that ship as provided in paragraph 2.5. Any such steps taken must be proportionate, taking into account the guidance given in part B of the ISPS Code.

2.5 Such steps are as follows:

- .1 a requirement for the rectification of the non-compliance;
- .2 a requirement that the ship proceed to a location specified in the territorial sea or internal waters of that Contracting Government;
- .3 inspection of the ship, if the ship is in the territorial sea of the Contracting Government the port of which the ship intends to enter; or
- .4 denial of entry into port.

Prior to initiating any such steps, the ship shall be informed by the Contracting Government of its intentions. Upon this information the master may withdraw the intention to enter that port. In such cases, this regulation shall not apply.

3 Additional provisions

3.1 In the event:

- .1 of the imposition of a control measure, other than a lesser administrative or corrective measure, referred to in paragraph 1.3; or
- .2 any of the steps referred to in paragraph 2.5 are taken,

an officer duly authorized by the Contracting Government shall forthwith inform in writing the Administration specifying which control measures have been imposed or steps taken and the reasons thereof. The Contracting Government imposing the control measures or steps shall also notify the recognized security organization which issued the Certificate relating to the ship concerned and the Organization when any such control measures have been imposed or steps taken.

3.2 When entry into port is denied or the ship is expelled from port, the authorities of the port State should communicate the appropriate facts to the authorities of the State of the next appropriate ports of call, when known, and any other appropriate coastal States, taking into account guidelines to be developed by the Organization. Confidentiality and security of such notification shall be ensured.

3.3 Denial of entry into port, pursuant to paragraphs 2.4 and 2.5, or expulsion from port, pursuant to paragraphs 1.1 to 1.3, shall only be imposed where the officers duly authorized by the Contracting Government have clear grounds to believe that the ship poses an immediate threat to the security or safety of persons, or of ships or other property and there are no other appropriate means for removing that threat.

3.4 The control measures referred to in paragraph 1.3 and the steps referred to in paragraph 2.5 shall only be imposed, pursuant to this regulation, until the non-compliance giving rise to the control measures or steps has been corrected to the satisfaction of the Contracting Government, taking into account actions proposed by the ship or the Administration, if any.

3.5 When Contracting Governments exercise control under paragraph 1 or take steps under paragraph 2:

- .1 all possible efforts shall be made to avoid a ship being unduly detained or delayed. If a ship is thereby unduly detained, or delayed, it shall be entitled to compensation for any loss or damage suffered; and
- .2 necessary access to the ship shall not be prevented for emergency or humanitarian reasons and for security purposes.

Regulation 10*Requirements for port facilities*

- 1 Port facilities shall comply with the relevant requirements of this chapter and part A of the ISPS Code, taking into account the guidance given in part B of the ISPS Code.
- 2 Contracting Governments with a port facility or port facilities within their territory, to which this regulation applies, shall ensure that:
 - .1 port facility security assessments are carried out, reviewed and approved in accordance with the provisions of part A of the ISPS Code; and
 - .2 port facility security plans are developed, reviewed, approved and implemented in accordance with the provisions of part A of the ISPS Code.
- 3 Contracting Governments shall designate and communicate the measures required to be addressed in a port facility security plan for the various security levels, including when the submission of a Declaration of Security will be required.

Regulation 11*Alternative security agreements*

- 1 Contracting Governments may, when implementing this chapter and part A of the ISPS Code, conclude in writing bilateral or multilateral agreements with other Contracting Governments on alternative security arrangements covering short international voyages on fixed routes between port facilities located within their territories.
- 2 Any such agreement shall not compromise the level of security of other ships or of port facilities not covered by the agreement.
- 3 No ship covered by such an agreement shall conduct any ship-to-ship activities with any ship not covered by the agreement.
- 4 Such agreements shall be reviewed periodically, taking into account the experience gained as well as any changes in the particular circumstances or the assessed threats to the security of the ships, the port facilities or the routes covered by the agreement.

Regulation 12*Equivalent security arrangements*

- 1 An Administration may allow a particular ship or a group of ships entitled to fly its flag to implement other security measures equivalent to those prescribed in this chapter or in part A of the ISPS Code, provided such security measures are at least as effective as those prescribed in this chapter or part A of the ISPS Code. The Administration which allows such security measures shall communicate to the Organization particulars thereof.
- 2 When implementing this chapter and part A of the ISPS Code, a Contracting Government may allow a particular port facility or a group of port facilities located within its territory, other than those covered by an agreement concluded under regulation 11, to implement security measures equivalent to those prescribed in this chapter or in part A of the ISPS Code, provided such security measures are at least as effective as those prescribed in this chapter or part A of the ISPS Code. The Contracting Government which allows such security measures shall communicate to the Organization particulars thereof.

Regulation 13

Communication of information

1 Contracting Governments shall, not later than 1 July 2004, communicate to the Organization and shall make available for the information of Companies and ships:

- .1 the names and contact details of their national authority or authorities responsible for ship and port facility security;
- .2 the locations within their territory covered by approved port facility security plans;
- .3 the names and contact details of those who have been designated to be available at all times to receive and act upon the ship-to-shore security alerts referred to in regulation 6.2.1;
- .4 the names and contact details of those who have been designated to be available at all times to receive and act upon any communications from Contracting Governments exercising control and compliance measures referred to in regulation 9.3.1; and
- .5 the names and contact details of those who have been designated to be available at all times to provide advice or assistance to ships and to whom ships can report any security concerns referred to in regulation 7.2

and thereafter update such information as and when changes relating thereto occur. The Organization shall circulate such particulars to other Contracting Governments for the information of their officers.

2 Contracting Governments shall, not later than 1 July 2004, communicate to the Organization the names and contact details of any recognized security organizations authorized to act on their behalf together with details of the specific responsibility and conditions of authority delegated to such organizations. Such information shall be updated as and when changes relating thereto occur. The Organization shall circulate such particulars to other Contracting Governments for the information of their officers.

3 Contracting Governments shall, not later than 1 July 2004, communicate to the Organization a list showing the approved port facility security plans for the port facilities located within their territory together with the location or locations covered by each approved port facility security plan and the corresponding date of approval and thereafter shall further communicate when any of the following changes take place:

- .1 changes in the location or locations covered by an approved port facility security plan are to be introduced or have been introduced. In such cases the information to be communicated shall indicate the changes in the location or locations covered by the plan and the date as of which such changes are to be introduced or were implemented;
- .2 an approved port facility security plan, previously included in the list submitted to the Organization, is to be withdrawn or has been withdrawn. In such cases, the information to be communicated shall indicate the date on which the withdrawal will take effect or was implemented. In these cases, the communication shall be made to the Organization as soon as is practically possible; and
- .3 additions are to be made to the list of approved port facility security plans. In such cases, the information to be communicated shall indicate the location or locations covered by the plan and the date of approval.

4 Contracting Governments shall, at 5-year intervals after 1 July 2004, communicate to the Organization a revised and updated list showing all the approved port facility security plans for the port facilities located within their territory together with the location or locations covered by each approved port facility security plan and the corresponding date of approval (and the date of approval of any amendments thereto) which will supersede and replace all information communicated to the Organization, pursuant to paragraph 3, during the preceding five years.

5 Contracting Governments shall communicate to the Organization information that an agreement under regulation 11 has been concluded. The information communicated shall include:

- .1 the names of the Contracting Governments which have concluded the agreement;
- .2 the port facilities and the fixed routes covered by the agreement;

- .3 the periodicity of review of the agreement;
- .4 the date of entry into force of the agreement; and
- .5 information on any consultations which have taken place with other Contracting Governments

and thereafter shall communicate, as soon as practically possible, to the Organization information when the agreement has been amended or has ended.

6 Any Contracting Government which allows, under the provisions of regulation 12, any equivalent security arrangements with respect to a ship entitled to fly its flag or with respect to a port facility located within its territory shall communicate to the Organization particulars thereof.

7 The Organization shall make available the information communicated under paragraphs 3 to 6 to other Contracting Governments upon request.

Chapter XII

Additional safety measures for bulk carriers

Chapter XII

Additional safety measures for bulk carriers

Regulation 1	Definitions.	463
Regulation 2	Application.	464
Regulation 3	Implementation schedule.	464
Regulation 4	Damage stability requirements applicable to bulk carriers.	464
Regulation 5	Structural strength of bulk carriers.	465
Regulation 6	Structural and other requirements for bulk carriers.	465
Regulation 7	Survey and maintenance of bulk carriers.	466
Regulation 8	Information on compliance with requirements for bulk carriers.	467
Regulation 9	Requirements for bulk carriers not being capable of complying with regulation 4.3 due to the design configuration of their cargo holds.	467
Regulation 10	Solid bulk cargo density declaration.	467
Regulation 11	Loading instrument.	468
Regulation 12	Hold, ballast and dry space water ingress alarms.	468
Regulation 13	Availability of pumping systems.	469
Regulation 14	Restrictions from sailing with any hold empty.	469
Unified Interpretations for Chapter XII.		471

Regulation 1

Definitions

For the purpose of this chapter:

- 1 *Bulk carrier* means a ship which is intended primarily to carry dry cargo in bulk, including such types as ore carriers and combination carriers.*
- 2 *Bulk carrier of single-side skin construction* means a bulk carrier as defined in paragraph 1, in which:
 - .1 any part of a cargo hold is bounded by the side shell; or
 - .2 one or more cargo holds are bounded by a double-side skin, the width of which is less than 760 mm in bulk carriers constructed before 1 January 2000 and less than 1,000 mm in bulk carriers constructed on or after 1 January 2000 but before 1 July 2006, the distance being measured perpendicular to the side shell.Such ships include combination carriers in which any part of a cargo hold is bounded by the side shell.
- 3 *Bulk carrier of double-side skin construction* means a bulk carrier as defined in paragraph 1, in which all cargo holds are bounded by a double-side skin, other than as defined in paragraph 2.2.
- 4 *Double-side skin* means a configuration where each ship side is constructed by the side shell and a longitudinal bulkhead connecting the double bottom and the deck. Hopper side tanks and top-side tanks may, where fitted, be integral parts of the double-side skin configuration.
- 5 *Length* of a bulk carrier means the length as defined in the International Convention on Load Lines in force.
- 6 *Solid bulk cargo* means any material, other than liquid or gas, consisting of a combination of particles, granules or any larger pieces of material, generally uniform in composition, which is loaded directly into the cargo spaces of a ship without any intermediate form of containment.
- 7 *Bulk carrier bulkhead and double bottom strength standards* means "Standards for the evaluation of scantlings of the transverse watertight vertically corrugated bulkhead between the two foremost cargo holds and for the evaluation of allowable hold loading of the foremost cargo hold" adopted by resolution 4 of the Conference of Contracting Governments to the International Convention for the Safety of Life at Sea, 1974 on 27 November 1997, as may be amended by the Organization, provided that such amendments are adopted, brought into force and take effect in accordance with the provisions of article VIII of the present Convention concerning the amendment procedures applicable to the annex other than chapter I.
- 8 *Bulk carriers constructed* means bulk carriers the keels of which are laid or which are at a similar stage of construction.
- 9 *A similar stage of construction* means the stage at which:
 - .1 construction identifiable with a specific ship begins; and
 - .2 assembly of that ship has commenced comprising at least 50 tonnes or 1% of the estimated mass of all structural material, whichever is less.
- 10 *Breadth (B)* of a bulk carrier means the breadth as defined in the International Convention on Load Lines in force.

* Refer to:

- .1 For ships constructed before 1 July 2006, resolution 6, Interpretation of the definition of "bulk carrier", as given in chapter IX of SOLAS 1974, as amended in 1994, adopted by the 1997 SOLAS Conference.
- .2 *Interpretation of the provisions of SOLAS chapter XII on additional safety measures for bulk carriers* (resolution MSC.79(70)).
- .3 The application provisions of annex 1 to the *Interpretation of the provisions of SOLAS chapter XII on additional safety measures for bulk carriers* (resolution MSC.89(71)).

Regulation 2

Application

Bulk carriers shall comply with the requirements of this chapter in addition to the applicable requirements of other chapters.

Regulation 3

Implementation schedule

Bulk carriers constructed before 1 July 1999 to which regulations 4 or 6 apply shall comply with the provisions of such regulations according to the following schedule, with reference to the enhanced programme of inspections required by regulation XI-1/2:

- .1 bulk carriers which are 20 years of age and over on 1 July 1999, by the date of the first intermediate survey or the first periodical survey* after 1 July 1999, whichever comes first;
- .2 bulk carriers which are 15 years of age and over but less than 20 years of age on 1 July 1999, by the date of the first periodical survey* after 1 July 1999, but not later than 1 July 2002; and
- .3 bulk carriers which are less than 15 years of age on 1 July 1999, by the date of the first periodical survey* after the date on which the ship reaches 15 years of age, but not later than the date on which the ship reaches 17 years of age.

Regulation 4

Damage stability requirements applicable to bulk carriers

SEE INTERPRETATION 1

1 Bulk carriers of 150 m in length and upwards of single-side skin construction, designed to carry solid bulk cargoes having a density of 1,000 kg/m³ and above, constructed on or after 1 July 1999, shall, when loaded to the Summer Load Line, be able to withstand flooding of any one cargo hold in all loading conditions and remain afloat in a satisfactory condition of equilibrium, as specified in paragraph 4.

2 Bulk carriers of 150 m in length and upwards of double-side skin construction in which any part of longitudinal bulkhead is located within $B/5$ or 11.5 m, whichever is less, inboard from the ship's side at right angle to the centreline at the assigned Summer Load Line, designed to carry solid bulk cargoes having a density of 1,000 kg/m³ and above, constructed on or after 1 July 2006, shall, when loaded to the Summer Load Line, be able to withstand flooding of any one cargo hold in all loading conditions and remain afloat in a satisfactory condition of equilibrium, as specified in paragraph 4.

3 Bulk carriers of 150 m in length and upwards of single-side skin construction, carrying solid bulk cargoes having a density of 1,780 kg/m³ and above, constructed before 1 July 1999, shall, when loaded to the Summer Load Line, be able to withstand flooding of the foremost cargo hold in all loading conditions and remain afloat in a satisfactory condition of equilibrium, as specified in paragraph 4. This requirement shall be complied with in accordance with the implementation schedule specified in regulation 3.

4 Subject to the provisions of paragraph 7, the condition of equilibrium after flooding shall satisfy the condition of equilibrium laid down in the annex to resolution A.320(IX) – *Regulation equivalent to regulation 27 of the International Convention on Load Lines, 1966*, as amended by resolution A.514(13). The assumed flooding need only take into account flooding of the cargo hold space to the water level outside the ship in that flooded condition. The permeability of a loaded hold shall be assumed as 0.9 and the permeability of an empty hold shall be assumed as 0.95, unless a permeability relevant to a particular cargo is assumed for the volume of a flooded hold occupied by cargo and a permeability of 0.95 is assumed for the remaining empty volume of the hold.

* Refer to *Application of SOLAS regulations XII/3, XII/7 and XII/11* (MSC.1/Circ.1463).

5 Bulk carriers constructed before 1 July 1999, which have been assigned a reduced freeboard in compliance with regulation 27(7) of the International Convention on Load Lines, 1966, as adopted on 5 April 1966, may be considered as complying with paragraph 3 of this regulation.

6 Bulk carriers which have been assigned a reduced freeboard in compliance with the provisions of paragraph (8) of the regulation equivalent to regulation 27 of the International Convention on Load Lines, 1966, adopted by resolution A.320(IX), as amended by resolution A.514(13), may be considered as complying with paragraphs 1 or 2, as appropriate.

7 On bulk carriers which have been assigned reduced freeboard in compliance with the provisions of regulation 27(8) of annex B of the Protocol of 1988 relating to the International Convention on Load Lines, 1966, the condition of equilibrium after flooding shall satisfy the relevant provisions of that Protocol.

Regulation 5

Structural strength of bulk carriers

SEE INTERPRETATION 2

1 Bulk carriers of 150 m in length and upwards of single-side skin construction, designed to carry solid bulk cargoes having a density of 1,000 kg/m³ and above, constructed on or after 1 July 1999, shall have sufficient strength to withstand flooding of any one cargo hold to the water level outside the ship in that flooded condition in all loading and ballast conditions, taking also into account dynamic effects resulting from the presence of water in the hold, and taking into account the recommendations adopted by the Organization.*

2 Bulk carriers of 150 m in length and upwards of double-side skin construction, in which any part of longitudinal bulkhead is located within $B/5$ or 11.5 m, whichever is less, inboard from the ship's side at right angle to the centreline at the assigned Summer Load Line, designed to carry bulk cargoes having a density of 1,000 kg/m³ and above, constructed on or after 1 July 2006, shall comply with the structural strength provisions of paragraph 1.

Regulation 6

Structural and other requirements for bulk carriers

SEE INTERPRETATION 3

1 Bulk carriers of 150 m in length and upwards of single-side skin construction, carrying solid bulk cargoes having a density of 1,780 kg/m³ and above, constructed before 1 July 1999, shall comply with the following requirements in accordance with the implementation schedule specified in regulation 3:

- .1 The transverse watertight bulkhead between the two foremost cargo holds and the double bottom of the foremost cargo hold shall have sufficient strength to withstand flooding of the foremost cargo hold, taking also into account dynamic effects resulting from the presence of water in the hold, in compliance with the bulk carrier bulkhead and double bottom strength standards. For the purpose of this regulation, the bulk carrier bulkhead and double bottom strength standards shall be treated as mandatory.
- .2 In considering the need for, and the extent of, strengthening of the transverse watertight bulkhead or double bottom to meet the requirements of 1.1, the following restrictions may be taken into account:
 - .1 restrictions on the distribution of the total cargo weight between the cargo holds; and
 - .2 restrictions on the maximum deadweight.

* Refer to *Recommendation on compliance with SOLAS regulation XII/5* (resolution 3 of the 1997 SOLAS Conference).

- .3 For bulk carriers using either of, or both, the restrictions given in 1.2.1 and 1.2.2 above for the purpose of fulfilling the requirements of 1.1, these restrictions shall be complied with whenever solid bulk cargoes having a density of $1,780 \text{ kg/m}^3$ and above are carried.
- 2 Bulk carriers of 150 m in length and upwards constructed on or after 1 July 2006, in all areas with double-side construction, shall comply with the following requirements:
- .1 Primary stiffening structures of the double-side skin shall not be placed inside the cargo hold space.
 - .2 Subject to the provisions below, the distance between the outer shell and the inner shell at any transverse section shall not be less than 1,000 mm measured perpendicular to the side shell. The double-side skin construction shall be such as to allow access for inspection as provided in regulation II-1/3-6 and the Technical Provisions referring thereto.
 - .1 The clearances below need not be maintained in way of cross ties, upper and lower end brackets of transverse framing or end brackets of longitudinal framing.
 - .2 The minimum width of the clear passage through the double-side skin space in way of obstructions such as piping or vertical ladders shall not be less than 600 mm.
 - .3 Where the inner and/or outer skins are transversely framed, the minimum clearance between the inner surfaces of the frames shall not be less than 600 mm.
 - .4 Where the inner and outer skins are longitudinally framed, the minimum clearance between the inner surfaces of the frames shall not be less than 800 mm. Outside the parallel part of the cargo hold length this clearance may be reduced where necessitated by the structural configuration, but shall in no case be less than 600 mm.
 - .5 The minimum clearance referred to above shall be the shortest distance measured between assumed lines connecting the inner surfaces of the frames on the inner and outer skins.
- 3 The double-side skin spaces, with the exception of top-side wing tanks, if fitted, shall not be used for the carriage of cargo.
- 4 In bulk carriers of 150 m in length and upwards, carrying solid bulk cargoes having a density of $1,000 \text{ kg m}^3$ and above, constructed on or after 1 July 2006:
- .1 the structure of cargo holds shall be such that all contemplated cargoes can be loaded and discharged by standard loading/discharge equipment and procedures without damage which may compromise the safety of the structure;
 - .2 effective continuity between the side shell structure and the rest of the hull structure shall be assured; and
 - .3 the structure of cargo areas shall be such that single failure of one stiffening structural member will not lead to immediate consequential failure of other structural items potentially leading to the collapse of the entire stiffened panels.

Regulation 7

Survey and maintenance of bulk carriers

SEE INTERPRETATION 4

- 1 Bulk carriers of 150 m in length and upwards of single-side skin construction, constructed before 1 July 1999, of 10 years of age and over, shall not carry solid bulk cargoes having a density of $1,780 \text{ kg/m}^3$ and above unless they have satisfactorily undergone either:
- .1 a periodical survey,* in accordance with the enhanced programme of inspections during surveys required by regulation XI-1/2; or

* Refer to *Application of SOLAS regulations XII/3, XII/7 and XII/11 (MSC.1/Circ.1463)*.

- .2 a survey of all cargo holds to the same extent as required for periodical surveys in the enhanced programme of inspections during surveys required by regulation XI-1/2.

2 Bulk carriers shall comply with the maintenance requirements provided in regulation II-1/3-1 and the *Standards for owners' inspection and maintenance of bulk carrier hatch covers*, adopted by the Organization by resolution MSC.169(79), as may be amended by the Organization, provided that such amendments are adopted, brought into force and take effect in accordance with the provisions of article VIII of the present Convention concerning the amendment procedures applicable to the annex other than chapter I.

Regulation 8

Information on compliance with requirements for bulk carriers

SEE INTERPRETATION 5

1 The booklet required by regulation VI/7.2 shall be endorsed by the Administration, or on its behalf, to indicate that regulations 4, 5, 6 and 7, as appropriate, are complied with.

2 Any restrictions imposed on the carriage of solid bulk cargoes having a density of 1,780 kg/m³ and above in accordance with the requirements of regulations 6 and 14 shall be identified and recorded in the booklet referred to in paragraph 1.

3 A bulk carrier to which paragraph 2 applies shall be permanently marked on the side shell at midships, port and starboard, with a solid equilateral triangle, having sides of 500 mm and its apex 300 mm below the deck line, and painted a contrasting colour to that of the hull.

Regulation 9

Requirements for bulk carriers not being capable of complying with regulation 4.3 due to the design configuration of their cargo holds

SEE INTERPRETATION 6

For bulk carriers constructed before 1 July 1999 being within the application limits of regulation 4.3, which have been constructed with an insufficient number of transverse watertight bulkheads to satisfy that regulation, the Administration may allow relaxation from the application of regulations 4.3 and 6, on condition that they shall comply with the following requirements:

- .1 for the foremost cargo hold, the inspections prescribed for the annual survey in the enhanced programme of inspections during surveys required by regulation XI-1/2 shall be replaced by the inspections prescribed therein for the intermediate survey of cargo holds;
- .2 they are provided with bilge well high water level alarms in all cargo holds, or in cargo conveyor tunnels, as appropriate, giving an audible and visual alarm on the navigation bridge, as approved by the Administration or an organization recognized by it in accordance with the provisions of regulation XI-1/1; and
- .3 they are provided with detailed information on specific cargo hold flooding scenarios. This information shall be accompanied by detailed instructions on evacuation preparedness under the provisions of section 8 of the International Safety Management (ISM) Code and be used as the basis for crew training and drills.

Regulation 10

Solid bulk cargo density declaration

SEE INTERPRETATION 7

1 Prior to loading bulk cargo on bulk carriers of 150 m in length and upwards, the shipper shall declare the density of the cargo, in addition to providing the cargo information required by regulation VI/2.

2 For bulk carriers to which regulation 6 applies, unless such bulk carriers comply with all relevant requirements of this chapter applicable to the carriage of solid bulk cargoes having a density of 1,780 kg/m³ and above, any cargo declared to have a density within the range 1,250 kg/m³ to 1,780 kg/m³ shall have its density verified by an accredited testing organization.*

Regulation 11

Loading instrument

SEE INTERPRETATION 8

(Unless provided otherwise, this regulation applies to bulk carriers regardless of their date of construction)

1 Bulk carriers of 150 m in length and upwards shall be fitted with a loading instrument capable of providing information on hull girder shear forces and bending moments, taking into account the recommendation adopted by the Organization.†

2 Bulk carriers of 150 m in length and upwards constructed before 1 July 1999 shall comply with the requirements of paragraph 1 not later than the date of the first intermediate or periodical survey‡ of the ship to be carried out after 1 July 1999.

3 Bulk carriers of less than 150 m in length constructed on or after 1 July 2006 shall be fitted with a loading instrument capable of providing information on the ship's stability in the intact condition. The computer software shall be approved for stability calculations by the Administration and shall be provided with standard conditions for testing purposes relating to the approved stability information.§

Regulation 12

Hold, ballast and dry space water ingress alarms¶

SEE INTERPRETATIONS 9 AND 10

(This regulation applies to bulk carriers regardless of their date of construction)

1 Bulk carriers shall be fitted with water level detectors:

- .1 in each cargo hold, giving audible and visual alarms, one when the water level above the inner bottom in any hold reaches a height of 0.5 m and another at a height not less than 15% of the depth of the cargo hold but not more than 2 m. On bulk carriers to which regulation 9.2 applies, detectors with only the latter alarm need be installed. The water level detectors shall be fitted in the aft end of the cargo holds. For cargo holds which are used for water ballast, an alarm overriding device may be installed. The visual alarms shall clearly discriminate between the two different water levels detected in each hold;
- .2 in any ballast tank forward of the collision bulkhead required by regulation II-1/12, giving an audible and visual alarm when the liquid in the tank reaches a level not exceeding 10% of the tank capacity. An alarm overriding device may be installed to be activated when the tank is in use; and

* In verifying the density of solid bulk cargoes, reference should be made to *Uniform method of measurement of the density of bulk cargoes* (MSC/Circ.908).

† Refer to *Recommendation on loading instruments* (resolution 5 of the 1997 SOLAS Conference).

‡ Refer to *Application of SOLAS regulations XII/3, XII/7 and XII/11* (MSC.1/Circ.1463).

§ Refer to the relevant parts of the appendix to *Guidelines for the on-board use and application of computers* (MSC/Circ.891), *Guidelines on the provision of stability-related information for bulk carriers* (MSC/Circ.1159) and *Uniform method of measurement of the density of bulk cargoes* (MSC/Circ.908).

¶ When water level detectors are installed on bulk carriers in compliance with regulation XII/12, the *Performance standards for water level detectors on bulk carriers and single hold cargo ships other than bulk carriers*, annexed to resolution MSC.188(79) adopted on 3 December 2004, should be applied.

- .3 in any dry or void space other than a chain cable locker, any part of which extends forward of the foremost cargo hold, giving an audible and visual alarm at a water level of 0.1 m above the deck. Such alarms need not be provided in enclosed spaces the volume of which does not exceed 0.1% of the ship's maximum displacement volume.
- 2 The audible and visual alarms specified in paragraph 1 shall be located on the navigation bridge.
- 3 Bulk carriers constructed before 1 July 2004 shall comply with the requirements of this regulation not later than the date of the annual, intermediate or renewal survey of the ship to be carried out after 1 July 2004, whichever comes first.

Regulation 13

*Availability of pumping systems**

SEE INTERPRETATIONS 11 AND 12

(This regulation applies to bulk carriers regardless of their date of construction)

- 1 On bulk carriers, the means for draining and pumping ballast tanks forward of the collision bulkhead and bilges of dry spaces any part of which extends forward of the foremost cargo hold shall be capable of being brought into operation from a readily accessible enclosed space, the location of which is accessible from the navigation bridge or propulsion machinery control position without traversing exposed freeboard or superstructure decks. Where pipes serving such tanks or bilges pierce the collision bulkhead, valve operation by means of remotely operated actuators may be accepted, as an alternative to the valve control specified in regulation II-1/12, provided that the location of such valve controls complies with this regulation.
- 2 Bulk carriers constructed before 1 July 2004 shall comply with the requirements of this regulation not later than the date of the first intermediate or renewal survey of the ship to be carried out after 1 July 2004, but in no case later than 1 July 2007.

Regulation 14

Restrictions from sailing with any hold empty

SEE INTERPRETATION 13

Bulk carriers of 150 m in length and upwards of single-side skin construction, carrying cargoes having a density of 1,780 kg/m³ and above, if not meeting the requirements for withstanding flooding of any one cargo hold as specified in regulation 5.1 and the *Standards and criteria for side structures of bulk carriers of single-side skin construction*, adopted by the Organization by resolution MSC.168(79), as may be amended by the Organization, provided that such amendments are adopted, brought into force and take effect in accordance with the provisions of article VIII of the present Convention concerning the amendment procedures applicable to the annex other than chapter I, shall not sail with any hold loaded to less than 10% of the hold's maximum allowable cargo weight when in the full load condition, after reaching 10 years of age. The applicable full load condition for this regulation is a load equal to or greater than 90% of the ship's deadweight at the relevant assigned freeboard.

* Refer to *Interpretation of SOLAS regulation XII/13* (MSC/Circ.1069).

Unified Interpretations for Chapter XII

1 Damage stability requirements applicable to bulk carriers *(Source: MSC-MEPC.2/Circ.10)*

Reg. 4 For single-hull oil tanker conversion into bulk carrier, the provisions of chapter XII applicable for ships constructed on or after the date on which conversion occurs should be applied as for a new ship to the entire bulk carrier, i.e. all new and existing parts and spaces, as follows:

- .1 Regulation 4.1 should be applied.
- .2 Regulation 4.2 applies, based on the Unified interpretations of SOLAS regulations XII/4.2 and XII/5.2 (MSC.1/Circ.1178).
- .3 Regulation 4.3 should not be applied.
- .4 Regulation 4.4 should be applied.
- .5 Regulation 4.5 should not be applied.
- .6 Regulations 4.6 and 4.7 should be applied.

2 Structural strength of bulk carriers *(Source: MSC-MEPC.2/Circ.10)*

Reg. 5 For single-hull oil tanker conversion into bulk carrier, the provisions of chapter XII applicable for ships constructed on or after the date on which conversion occurs should be applied as for a new ship to the entire bulk carrier, i.e. all new and existing parts and spaces, as follows:

- .1 Regulation 5.1 should apply.
- .2 Regulation 5.2 should apply, based on the following: for ships constructed on or after 1 July 2006, only cargo holds the double side-skin space of which does not meet the specified dimension need to be considered flooded.

3 Structural and other requirements for bulk carriers *(Source: MSC-MEPC.2/Circ.10)*

Reg. 6 For single-hull oil tanker conversion into bulk carrier, the provisions of chapter XII applicable for ships constructed on or after the date on which conversion occurs should be applied as for a new ship to the entire bulk carrier, i.e. all new and existing parts and spaces, as follows:

- .1 Regulation 6.1 should not be applied.
- .2 Regulation 6.2 should be applied.
- .3 Regulation 6.3 should be applied.
- .4 Regulation 6.4 should be applied.

4 Survey and maintenance of bulk carriers *(Source: MSC-MEPC.2/Circ.10)*

Reg. 7 For single-hull oil tanker conversion into bulk carrier, the provisions of chapter XII applicable for ships constructed on or after the date on which conversion occurs should be applied as for a new ship to the entire bulk carrier, i.e. all new and existing parts and spaces, as follows:

- .1 Regulation 7.1 should not be applied. However, SOLAS regulation XI-1/2 is applicable.
- .2 Regulation 7.2 should be applied.

5 Information on compliance with requirements for bulk carriers *(Source: MSC-MEPC.2/Circ.10)*

Reg. 8 For single-hull oil tanker conversion into bulk carrier, the provisions of chapter XII applicable for ships constructed on or after the date on which conversion occurs should be applied as for a new ship to the entire bulk carrier, i.e. all new and existing parts and spaces, as follows:

- .1 Regulation 8.1 should be applied.
- .2 Regulations 8.2 and 8.3 should not be applied.

- 6 Requirements for bulk carriers not being capable of complying with regulation 4.3 due to the design configuration of their cargo holds** (Source: MSC-MEPC.2/Circ.10)

Reg. 9 This regulation should not be applied to single-hull oil tanker conversion into bulk carrier.

- 7 Solid bulk cargo density declaration** (Source: MSC-MEPC.2/Circ.10)

Reg. 10 For single-hull oil tanker conversion into bulk carrier, the provisions of chapter XII applicable for ships constructed on or after the date on which conversion occurs should be applied as for a new ship to the entire bulk carrier, i.e. all new and existing parts and spaces, as follows:

- .1 Regulation 10.1 should be applied.
- .2 Regulation 10.2 should not be applied.

- 8 Loading instrument** (Source: MSC-MEPC.2/Circ.10)

Reg. 11 For single-hull oil tanker conversion into bulk carrier, the provisions of chapter XII applicable for ships constructed on or after the date on which conversion occurs should be applied as for a new ship to the entire bulk carrier, i.e. all new and existing parts and spaces, as follows:

- .1 Regulation 11.1 should be applied.
- .2 Regulation 11.2 should not be applied.
- .3 Regulation 11.3 should be applied.

- 9 Hold, ballast and dry space water ingress alarms** (Source: MSC.1/Circ.1572)

Reg. 12 When water level detectors are installed on bulk carriers in compliance with regulation XII/12, the Performance standards for water level detectors on bulk carriers and single hold cargo ships other than bulk carriers, annexed to resolution MSC.188(79) adopted on 3 December 2004, should be applied, taking into account the following interpretations to the paragraphs of the Performance standards.

- 9.1 Performance standards for water level detectors on bulk carriers and single hold cargo ships other than bulk carriers, paragraph 3.2.3

Interpretation

Detection equipment includes the sensor and any filter and protection arrangements for the detector installed in cargo holds and other spaces as required by regulation XII/12.1.

- 9.2 Performance standards for water level detectors on bulk carriers and single hold cargo ships other than bulk carriers, paragraph 3.2.5

Interpretation

9.2.1 In general, the construction and type testing should be in accordance with publication IEC 60079: Electrical Equipment for Explosive Gas Atmospheres to a minimum requirement of EX(ja). Where a ship is designed only for the carriage of cargoes that cannot create a combustible or explosive atmosphere then the requirement for intrinsically safe circuitry should not be insisted upon, provided the operational instructions included in the Manual required by 4.1 of the appendix to the annex specifically exclude the carriage of cargoes that could produce a potential explosive atmosphere. Any exclusion of cargoes identified in the annex should be consistent with the ship's Cargo Book and any Certification relating to the carriage of specifically identified cargoes.

9.2.2 The maximum surface temperature of equipment installed within cargo spaces should be appropriate for the combustible dusts and/or explosive gases likely to be encountered. Where the characteristics of the dust and gases are unknown, the maximum surface temperature of equipment should not exceed 85°C.

9.2.3 Where intrinsically safe equipment is installed, it should be of a certified safe type.

9.2.4 Where detector systems include intrinsically safe circuits, plans of the arrangements should be appraised/approved by individual classification societies.

9.3 Performance standards for water level detectors on bulk carriers and single hold cargo ships other than bulk carriers, paragraph 3.3.2

Interpretation

The pre-alarm, as a primary alarm, should indicate a condition that requires prompt attention to prevent an emergency condition and the main alarm, as an emergency alarm should indicate that immediate actions must be taken to prevent danger to human life or to the ship.

9.4 Performance standards for water level detectors on bulk carriers and single hold cargo ships other than bulk carriers, paragraph 3.3.7

Interpretation

Fault monitoring should address faults associated with the system that include open circuit, short circuit, as well as arrangement details that would include loss of power supplies and CPU failure for computer-based alarm/monitoring system, etc.

9.5 Performance standards for water level detectors on bulk carriers and single hold cargo ships other than bulk carriers, paragraph 3.3.8

Interpretation

9.5.1 The electrical power supply should be from two separate sources, one should be the main source of electrical power and the other should be the emergency source, unless a continuously charged dedicated accumulator battery is fitted, having arrangement, location and endurance equivalent to that of the emergency source (18 hours). The battery supply may be an internal battery in the water level detector system.

9.5.2 The changeover arrangement of supply from one electrical source to another need not be integrated into the water level detector system.

9.5.3 Where batteries are used for the secondary power supply, failure alarms for both power supplies should be provided.

9.6 Performance standards for water level detectors on bulk carriers and single hold cargo ships other than bulk carriers, footnote to paragraph 3.4.1

Interpretation

9.6.1 IACS UR E10 may be used as an equivalent test standard to IEC 60092-504.

9.6.2 The range of tests should include the following:

For alarm/monitoring panel:

- .1 functional tests in accordance with resolution MSC.188(79) on the *Performance standards for water level detectors on bulk carriers and single hold cargo ships other than bulk carriers*;
- .2 electrical power supply failure test;
- .3 power supply variation test;
- .4 dry heat tests;
- .5 damp heat tests;
- .6 vibration test;
- .7 EMC tests;
- .8 insulation resistance test;
- .9 high-voltage test; and
- .10 static and dynamic inclinations tests, if moving parts are contained.

For IS barrier unit, if located in the wheelhouse: in addition to the certificate issued by a competent independent testing laboratory, EMC tests should also be carried out.

For water ingress detectors:

- .1 functional tests in accordance with resolution MSC.188(79) on the *Performance standards for water level detectors on bulk carriers and single hold cargo ships other than bulk carriers*;
- .2 electrical power supply failure test;
- .3 power supply variation test;
- .4 dry-heat test;

- .5 damp-heat test;
- .6 vibration test;
- .7 enclosure class in accordance with resolution MSC.188(79) on the *Performance standards for water level detectors on bulk carriers and single hold cargo ships other than bulk carriers*;
- .8 insulation resistance test;
- .9 high-voltage test; and
- .10 static and dynamic inclinations tests (if the detectors contain moving parts).

9.7 Performance standards for water level detectors on bulk carriers and single hold cargo ships other than bulk carriers, appendix, paragraph 2.1.1

Interpretation

The test procedure should satisfy the following criteria:

- .1 the type tests should be witnessed by a classification society surveyor if the tests are not carried out by a competent independent test facility;
- .2 type tests should be carried out on a prototype or randomly selected item(s) which are representative of the manufactured item that is being type tested; and
- .3 type tests should be documented (type test reports) by the manufacturer and submitted for review by classification societies.

9.8 Performance standards for water level detectors on bulk carriers and single hold cargo ships other than bulk carriers, appendix, paragraph 2.1.1.1

Interpretation

9.8.1 The submerged test period for electrical components intended to be installed in ballast tanks and cargo tanks used as ballast tanks should be not less than 20 days.

9.8.2 The submerged test period for electrical components intended to be installed in dry spaces and cargo holds not intended to be used as ballast tanks should be not less than 24 hours.

9.8.3 Where a detector and/or cable connecting device (e.g. junction box, etc.) is installed in a space adjacent to a cargo hold (e.g. lower stool, etc.) and the space is considered to be flooded under damage stability calculations, the detectors and equipment should satisfy the requirements of IP68 for a water head equal to the hold depth for a period of 20 days or 24 hours on the basis of whether or not the cargo hold is intended to be used as a ballast tank as described in the previous paragraphs.

9.9 Performance standards for water level detectors on bulk carriers and single hold cargo ships other than bulk carriers, appendix, paragraph 2.1.1.2

Interpretation

9.9.1 The type test required for the sensor should be in accordance with the following:

- .1 The test container for the cargo/water mixture should be dimensioned so that its height and volume are such that the sensor and any filtration fitted can be totally submerged for the repeated functionality tests required by paragraph 2.1.1.2 and the static and dynamic inclination tests identified in the previous interpretation.
- .2 The sensor and any filtration fitted that should be submerged and should be arranged in the container as they would be installed in accordance with the installation instructions required by paragraph 4.4.
- .3 The pressure in the container for testing the complete detector should be not more than 0.2 bar at the sensor and any filter arrangement. The pressure may be realized by pressurization or by using a container of sufficient height.
- .4 The cargo/water mixture should be pumped into the test container and suitable agitation of the mixture provided to keep the solids in suspension. The effect of pumping the cargo/water mixture into the container should not affect the operation of the sensor and filter arrangements.
- .5 The cargo/water mixture should be pumped into the test container to a predetermined level that submerges the detector and the operation of the alarm observed.
- .6 The test container should then be drained and the deactivation of the alarm condition observed.
- .7 The test container and sensor with any filter arrangement should be allowed to dry without physical intervention.

- .8 The test procedure should be repeated consecutively ten times without cleaning any filter arrangement that may be fitted in accordance with the manufacturer's installation instructions (see also 2.1.1.2).
- .9 Satisfactory alarm activation and deactivation at each of the 10 consecutive tests will demonstrate satisfactory type testing.

9.9.2 The cargo/water mixture used for type testing should be representative of the range of cargoes within the following groups and should include the cargo with the smallest particles expected to be found from a typical representative sample:

- .1 iron ore particles and seawater;
- .2 coal particles and seawater;
- .3 grain particles and seawater; and
- .4 aggregate (sand) particles and seawater.

The smallest and largest particle size together with the density of the dry mixture should be ascertained and recorded. The particles should be evenly distributed throughout the mixture. Type testing with representative particles will in general qualify all types of cargoes within the four groupings shown above.

The following provides guidance on the selection of particles for testing purposes:

- .1 Iron ore particles should mainly consist of small loose screenings of iron ore and not lumps of ore (dust with particle size < 0.1 mm).
- .2 Coal particles should mainly consist of small loose screenings of coal and not lumps of coal (dust with particle size < 0.1 mm).
- .3 Grain particles should mainly consist of small loose grains of free-flowing grain (grain having a size > 3 mm, such as wheat).
- .4 Aggregate particles should mainly consist of small loose grains of free-flowing sand and without lumps (dust with particle size < 0.1 mm).

9.10 Performance standards for water level detectors on bulk carriers and single hold cargo ships other than bulk carriers, appendix, paragraph 3.1.1

Interpretation

The test procedure should satisfy the following criteria:

- .1 type tests should be witnessed by a classification society surveyor if the tests are not carried out by a competent independent test facility;
- .2 type tests should be carried out on a prototype or randomly selected item(s) which are representative of the manufactured item that is being type tested; and
- .3 type tests should be documented (type test reports) by the manufacturer and submitted for review by classification societies.

9.11 Performance standards for water level detectors on bulk carriers and single hold cargo ships other than bulk carriers, appendix, section 4 – manuals

Interpretation

For each ship, a copy of the manual should be made available to the surveyor at least 24 hours prior to survey of the water-level detection installation. Each classification society should ensure that any plans required for classification purposes have been appraised/approved as appropriate.

10 Hold, ballast and dry space water ingress alarms (Source: MSC-MEPC.2/Circ.10)

Reg. 12 For single-hull oil tanker conversion into bulk carrier, the provisions of chapter XII applicable for ships constructed on or after the date on which conversion occurs should be applied as for a new ship to the entire bulk carrier, i.e. all new and existing parts and spaces, as follows:

- .1 Regulations 12.1 and 12.2 should be applied.
- .2 Regulation 12.3 should not be applied.

11 Dewatering of forward spaces of bulk carriers (Source: MSC.1/Circ.1572)

Reg. 13 11.1 Where the piping arrangements for dewatering closed dry spaces are connected to the piping arrangements for the drainage of water ballast tanks, two non-return valves should be provided to prevent the ingress of water into dry spaces from those intended for the carriage of water ballast. One of these non-return valves should be fitted with a shut-off isolation arrangement. The non-return valves should be

located in readily accessible positions. The shut-off isolation arrangement should be capable of being controlled from the navigation bridge, the propulsion machinery control position or enclosed space which is readily accessible from the navigation bridge or the propulsion machinery control position without travelling exposed freeboard or superstructure decks. In this context, a position which is accessible via an under-deck passage, a pipe trunk or other similar means of access should not be taken as being in the "readily accessible enclosed space".

11.2 Under regulation XII/13.1:

- .1 the valve specified under SOLAS regulation II-1/12.6.1 should be capable of being controlled from the navigation bridge, the propulsion machinery control position or enclosed space which is readily accessible from the navigation bridge or the propulsion machinery control position without travelling exposed freeboard or superstructure decks. In this context, a position which is accessible via an under-deck passage, a pipe trunk or other similar means of access should not be taken as being in the "readily accessible enclosed space";
- .2 the valve should not move from the demanded position in the case of failure of the control system power or actuator power;
- .3 positive indication should be provided at the remote control station to show that the valve is fully open or closed; and
- .4 local hand-powered valve operation from above the freeboard deck, as permitted under SOLAS regulation II-1/12.6.1, is required. An acceptable alternative to such arrangement may be remotely operated actuators as specified in regulation XII/13.1, on the condition that all of the provisions of regulation XII/13.1 are met.

11.3 The dewatering arrangements should be such that any accumulated water can be drained directly by a pump or eductor.

11.4 The dewatering arrangements should be such that when they are in operation, other systems essential for the safety of the ship, including firefighting and bilge systems, remain available and ready for immediate use. The systems for normal operation of electric power supplies, propulsion and steering should not be affected by the operation of the dewatering systems. It should also be possible to immediately start fire pumps and have a readily available supply of firefighting water, and to be able to configure and use the bilge system for any compartment when the dewatering system is in operation.

11.5 Bilge wells should be provided with gratings or strainers that will prevent blockage of the dewatering system with debris.

11.6 The enclosures of electrical equipment for the dewatering system installed in any of the forward dry spaces should provide protection to IPX8 standard as defined in publication IEC 60529 for a water head equal to the height of the space in which the electrical equipment is installed for a time duration of at least 24 hours.

12 Availability of pumping systems

(Source: MSC-MEPC.2/Circ.10)

Reg. 13

For single-hull oil tanker conversion into bulk carrier, the provisions of chapter XII applicable for ships constructed on or after the date on which conversion occurs should be applied as for a new ship to the entire bulk carrier, i.e. all new and existing parts and spaces, as follows:

- .1 Regulations 13.1 should be applied.
- .2 Regulation 13.2 should not be applied.

13 Restrictions from sailing with any hold empty

(Source: MSC-MEPC.2/Circ.10)

Reg. 14

This regulation should not be applied to single-hull oil tanker conversion into bulk carrier.

Chapter XIII

Verification of compliance

Chapter XIII

Verification of compliance

Regulation 1	Definitions.	481
Regulation 2	Application	481
Regulation 3	Verification of compliance	481

Regulation 1

Definitions

For the purpose of this chapter:

- 1 *Audit* means a systematic, independent and documented process for obtaining audit evidence and evaluating it objectively to determine the extent to which audit criteria are fulfilled.
- 2 *Audit Scheme* means the IMO Member State Audit Scheme established by the Organization and taking into account the guidelines developed by the Organization.*
- 3 *Code for Implementation* means the IMO Instruments Implementation Code (III Code) adopted by the Organization by resolution A.1070(28).
- 4 *Audit Standard* means the Code for Implementation.

Regulation 2

Application

Contracting Governments shall use the provisions of the Code for Implementation in the execution of their obligations and responsibilities[†] contained in the present Convention.

Regulation 3

Verification of compliance

- 1 Every Contracting Government shall be subject to periodic audits by the Organization in accordance with the audit standard to verify compliance with and implementation of the present Convention.
- 2 The Secretary-General of the Organization shall have responsibility for administering the Audit Scheme, based on the guidelines developed by the Organization.*
- 3 Every Contracting Government shall have responsibility for facilitating the conduct of the audit and implementation of a programme of actions to address the findings, based on the guidelines adopted by the Organization.*
- 4 Audit of all Contracting Governments shall be:
 - .1 based on an overall schedule developed by the Secretary-General of the Organization, taking into account the guidelines developed by the Organization;* and
 - .2 conducted at periodic intervals, taking into account the guidelines developed by the Organization.*

* Refer to the *Framework and Procedures for the IMO Member State Audit Scheme* (resolution A.1067(28)).

† Refer to *2019 Non-exhaustive list of obligations under instruments relevant to the IMO Instruments Implementation Code (III Code)* (resolution A.1141(31)), as may be amended, and *Guidance on communication of information by Member States* (resolution A.1139(31)).

Chapter XIV

Safety measures for ships
operating in polar waters

Chapter XIV

Safety measures for ships operating in polar waters

Regulation 1	Definitions	487
Regulation 2	Application	487
Regulation 3	Requirements for ships to which this chapter applies	488
Regulation 4	Alternative design and arrangement	488
Unified Interpretations for Chapter XIV		489

Regulation 1

Definitions

For the purpose of this chapter:

1 *Polar Code* means the International Code for Ships Operating in Polar Waters, consisting of an introduction and parts I-A and II-A and parts I-B and II-B, as adopted by resolutions MSC.385(94) and of the Marine Environment Protection Committee,* as may be amended, provided that:

- .1 amendments to the safety-related provisions of the introduction and part I-A of the Polar Code are adopted, brought into force and take effect in accordance with the provisions of article VIII of the present Convention concerning the amendment procedures applicable to the annex other than chapter I; and
- .2 amendments to part I-B of the Polar Code are adopted by the Maritime Safety Committee in accordance with its Rules of Procedure.

2 *Antarctic area* means the sea area south of latitude 60° S.

3 *Arctic waters* means those waters which are located north of a line from the latitude 58°00'.0 N and longitude 042°00'.0 W to latitude 64°37'.0 N, longitude 035°27'.0 W and thence by a rhumb line to latitude 67°03'.9 N, longitude 026°33'.4 W and thence by a rhumb line to the latitude 70°49'.56 N and longitude 008°59'.61 W (Sørkapp, Jan Mayen) and by the southern shore of Jan Mayen to 73°31'.6 N and 019°01'.0 E by the Island of Bjørnøya, and thence by a great circle line to the latitude 68°38'.29 N and longitude 043°23'.08 E (Cap Kanin Nos) and hence by the northern shore of the Asian Continent eastward to the Bering Strait and thence from the Bering Strait westward to latitude 60° N as far as Il'pyskiy and following the 60th North parallel eastward as far as and including Etolin Strait and thence by the northern shore of the North American continent as far south as latitude 60° N and thence eastward along parallel of latitude 60° N, to longitude 056°37'.1 W and thence to the latitude 58°00'.0 N, longitude 042°00'.0 W.

4 *Polar waters* means Arctic waters and/or the Antarctic area.

5 *Ship constructed* means a ship the keel of which is laid or which is at a similar stage of construction.

6 *At a similar stage of construction* means the stage at which:

- .1 construction identifiable with a specific ship begins; and
- .2 assembly of that ship has commenced comprising at least 50 tonnes or 1% of the estimated mass of all structural material, whichever is less.

Regulation 2

Application

1 Unless expressly provided otherwise, this chapter applies to ships operating in polar waters, certified in accordance with chapter 1.†

2 Ships constructed before 1 January 2017 shall meet the relevant requirements of the Polar Code by the first intermediate or renewal survey, whichever occurs first, after 1 January 2018.

SEE INTERPRETATION 1

* Refer to the resolution of adoption of the *International Code for Ships Operating in Polar Waters* (MEPC.264(68)), by the Marine Environment Protection Committee.

† Refer to the *Interim safety measures for ships not certified under the SOLAS Convention operating in polar waters* (resolution A.1137(31)).

3 In applying part I-A of the Polar Code, consideration should be given to the additional guidance in part I-B of the Polar Code.

4 This chapter shall not apply to ships owned or operated by a Contracting Government and used, for the time being, only in government non-commercial service. However, ships owned or operated by a Contracting Government and used, for the time being, only in government non-commercial service are encouraged to act in a manner consistent, so far as reasonable and practicable, with this chapter.

5 Nothing in this chapter shall prejudice the rights or obligations of States under international law.

Regulation 3

Requirements for ships to which this chapter applies

1 Ships to which this chapter applies shall comply with the requirements of the safety-related provision of the introduction and with part I-A of the Polar Code and shall, in addition to the requirements of regulations I/7, I/8, I/9, and I/10, as applicable, be surveyed and certified, as provided for in that Code.

2 Ships to which this chapter applies holding a certificate issued pursuant to the provisions of paragraph 1 shall be subject to the control established in regulations I/19 and XI-1/4. For this purpose, such certificates shall be treated as a certificate issued under regulation I/12 or I/13.

Regulation 4

Alternative design and arrangement

1 The goal of this regulation is to provide a methodology for alternative design and arrangements for structure, machinery, and electrical installations, fire safety and life saving appliances and arrangements.

2 Structural arrangements, machinery and electrical installation, fire safety design and arrangement measures and as well as life-saving appliances and arrangements may deviate from the prescriptive requirements set out in chapters 3, 6, 7 and 8 of the Polar Code, provided that the alternative design and arrangements meet the intent of the goal and functional requirements concerned and provide an equivalent level of safety to the requirements in those chapters.

3 When alternative designs or arrangements deviate from the prescriptive requirements of chapters 3, 6, 7 and 8 of the Polar Code, an engineering analysis, evaluation and approval of the design and arrangements shall be carried out based on the guidelines approved by the Organization.*

4 Any alternative designs or arrangement deviating from the prescriptive requirements shall be recorded in the Polar Ship Certificate and the ship's Polar Water Operational Manual, as required by the Polar Code, also defining the technical and operational measures and conditions for the allowed deviation.

* Refer to the *Guidelines for the approval of alternatives and equivalents as provided for in various IMO instruments* (MSC.1/Circ.1455), the *Revised guidelines on alternative design and arrangements for SOLAS chapters II-1 and III* (MSC.1/Circ.1212/Rev.1) and the *Guidelines on alternative design and arrangements for fire safety* (MSC/Circ.1002 and its Corr.1, Corr.2 and Corr.3, as amended by MSC.1/Circ.1552), as applicable.

Unified Interpretations for Chapter XIV

1 Safety measures for ships operating in polar waters (Source: MSC.1/Circ.1562)

Reg. 2.2 The implementation of initial and maintenance surveys as required in SOLAS regulation XIV/2.2, as adopted by resolution MSC.386(94), and paragraphs 1.3.2 and 1.3.6, part I-A of the Polar Code, as adopted by resolution MSC.385(94), should be interpreted as indicated in the following table:

Initial and maintenance surveys pertaining to SOLAS Chapter XIV and the Polar Code

1. Ships under Harmonized System of Survey and Certification (HSSC) Scheme			
Type of ship	Initial Survey for issuance of the Polar Ship Certificate	Surveys for the maintenance of the Polar Ship Certificate	Surveys for renewal of the Polar Ship certificate
Passenger Ship	First passenger ship's safety renewal survey after 1 January 2018.	Not applicable.	Every year.
Cargo ship	First Safety Construction intermediate survey or renewal survey, as required by SOLAS regulation I/10, whichever occurs first after 1 January 2018.	<p>a) Aligned with maintenance survey (annual or intermediate) related to the Cargo Ship Safety Certificate. The Polar Ship Certificate should be endorsed upon satisfactory results of the maintenance survey related to the Polar Code and Cargo Ship Safety; or</p> <p>b) Aligned with maintenance survey (annual or intermediate) related to the Safety Construction Certificate. The Polar Ship Certificate should be endorsed upon satisfactory results of the maintenance survey (annual or intermediate) related to the Polar Code and Safety Construction, provided that valid Safety Equipment and Safety Radio Certificates are held by a ship.</p>	<p>a) Aligned with renewal survey related to the Cargo Ship Safety Certificate. The Polar Ship Certificate should be reissued upon satisfactory results of the renewal survey related to the Polar Code and Cargo Ship Safety; or</p> <p>b) Aligned with renewal Survey of Safety Construction. The Polar Ship Certificate should be reissued upon satisfactory results of the renewal survey related to the Polar Code and Safety Construction, provided that Safety Equipment and Safety Radio Certificates are held by a ship.</p>

2. Ships not under HSSC Scheme			
Type of ship	Initial Survey for issuance of the Polar Ship Certificate	Surveys for the maintenance of the Polar Ship Certificate	Surveys for renewal of the Polar Ship certificate
Passenger Ship	First passenger ship's safety renewal survey after 1 January 2018.	Not applicable.	Every year.
Cargo ship	First Safety Construction renewal survey as required by SOLAS regulation I/10, which occurs after 1 January 2018 but, in any case, not later than 31 March 2021.	Aligned with maintenance survey (annual or intermediate) related to the Safety Construction Certificate. The Polar Ship Certificate should be endorsed upon satisfactory results of maintenance survey (annual or intermediate) related to the Polar Code and Safety Construction, provided that valid Safety Equipment and Safety Radio Certificates are held by a ship.	Aligned with renewal Survey of Safety Construction. The Polar Ship Certificate should be reissued upon satisfactory results of the renewal survey related to Polar Code and Safety Construction, provided that Safety Equipment and Safety Radio Certificates are held by a ship.

Appendix

Certificates

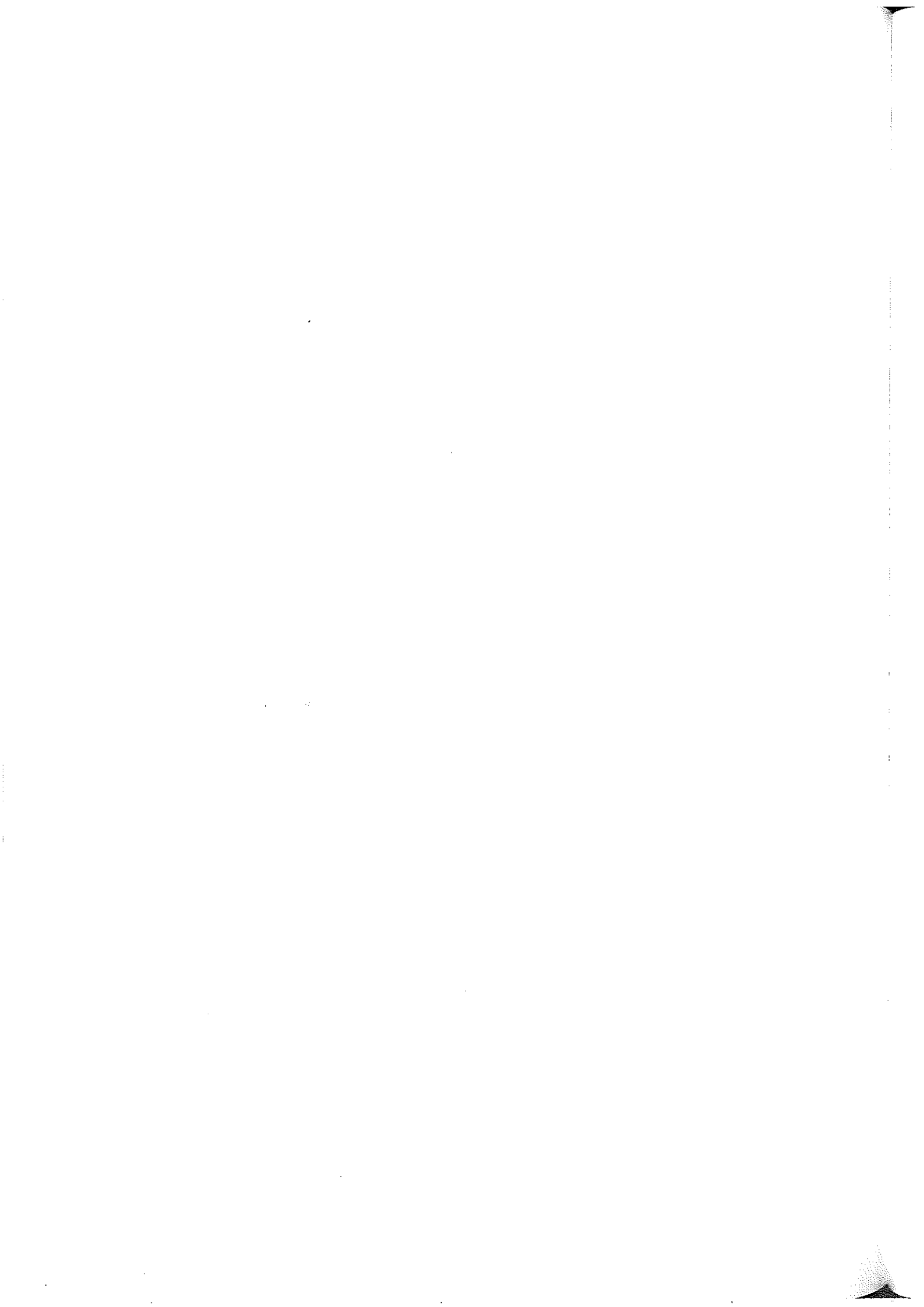

Appendix Certificates*

P88 Form of safety certificate for passenger ships	495
Record of equipment for passenger ship safety (Form P)	498
P88 Form of safety construction certificate for cargo ships	502
P88 Form of safety equipment certificate for cargo ships	507
Record of equipment for cargo ship safety (Form E)	512
P88 Form of safety radio certificate for cargo ships	515
Record of equipment for cargo ship safety radio (Form R)	520
P88 Form of safety certificate for cargo ships	522
P88 Form of exemption certificate	531
Form of safety certificate for nuclear passenger ships	534
Form of safety certificate for nuclear cargo ships	537
Record of equipment for cargo ship safety (Form C)	539
Unified Interpretations for the Appendix	543

* The present appendix contains the forms of certificates and records of equipment of the 1974 SOLAS Convention, as modified by the 1988 SOLAS Protocol. States which are Contracting Governments to the 1974 SOLAS Convention but not Parties to the 1988 SOLAS Protocol may issue certificates in the form prescribed by the 1988 SOLAS Protocol in accordance with Assembly resolution A.883(21) relating to the global implementation of the harmonized system of survey and certification.



Form of safety certificate for passenger ships

PASSENGER SHIP SAFETY CERTIFICATE

This Certificate shall be supplemented by a Record of Equipment for Passenger Ship Safety (Form P)

(official seal)

(State)

for an/a short¹ international voyage

Issued under the provisions of the
INTERNATIONAL CONVENTION FOR THE SAFETY OF LIFE AT SEA, 1974,
as modified by the Protocol of 1988 relating thereto

under the authority of the Government of

_____ *(name of the State)*

by _____

(person or organization authorized)

Particulars of ship²

Name of ship _____

Distinctive number or letters _____

Port of registry _____

Gross tonnage _____

Sea areas in which ship is certified to operate (regulation IV/2) _____

IMO Number³ _____

Date of build

Date of building contract _____

Date on which keel was laid or ship was at similar stage of construction _____

Date of delivery _____

Date on which work for a conversion or an alteration or modification
of a major character was commenced (where applicable) _____

All applicable dates shall be completed.

¹ Delete as appropriate.

² Alternatively, the particulars of the ship may be placed horizontally in boxes.

³ In accordance with the IMO ship identification number scheme (resolution A.1117(30)).

THIS IS TO CERTIFY:

- 1 That the ship has been surveyed in accordance with the requirements of regulation I/7 of the Convention.
- 2 That the survey showed that:
 - 2.1 the ship complied with the requirements of the Convention as regards:
 - .1 the structure, main and auxiliary machinery, boilers and other pressure vessels;
 - .2 the watertight subdivision arrangements and details;
 - .3 the following subdivision load lines:

Subdivision load lines assigned and marked on the ship's side amidships (regulation II-1/18) ⁴	Freeboard	To apply when the spaces in which passengers are carried include the following alternative spaces
P1		
P2		
P3		

- 2.2 the ship complied with part G of chapter II-1 of the Convention using as fuel/N.A.¹;
- 2.3 the ship complied with the requirements of the Convention as regards structural fire protection, fire safety systems and appliances and fire control plans;
- 2.4 the life-saving appliances and the equipment of the lifeboats, liferafts and rescue boats were provided in accordance with the requirements of the Convention;
- 2.5 the ship was provided with a line-throwing appliance and radio installations used in life-saving appliances in accordance with the requirements of the Convention;
- 2.6 the ship complied with the requirements of the Convention as regards radio installations;
- 2.7 the functioning of the radio installations used in life-saving appliances complied with the requirements of the Convention;
- 2.8 the ship complied with the requirements of the Convention as regards shipborne navigational equipment, means of embarkation for pilots and nautical publications;
- 2.9 the ship was provided with lights, shapes, means of making sound signals and distress signals, in accordance with the requirements of the Convention and the International Regulations for Preventing Collisions at Sea in force;
- 2.10 in all other respects the ship complied with the relevant requirements of the Convention;
- 2.11 the ship was/was not¹ subjected to an alternative design and arrangements in pursuance of regulation(s) II-1/55 / II-2/17 / III/38¹ of the Convention;
- 2.12 a Document of approval of alternative design and arrangements for machinery and electrical installations/fire protection/life-saving appliances and arrangements¹ is/is not¹ appended to this Certificate.
- 3 That an Exemption Certificate has/has not¹ been issued.

This certificate is valid until _____

Completion date of the survey on which this certificate is based _____ (dd/mm/yyyy)

Issued at _____
(place of issue of certificate)

(date of issue)

(signature of authorized official
issuing the certificate)

(seal or stamp of the authority, as appropriate)

¹ Delete as appropriate.

⁴ For ships constructed before 1 January 2009, the applicable subdivision notation "C.1", "C.2" and "C.3" should be used.

Endorsement where the renewal survey has been completed and regulation I/14(d) applies

The ship complies with the relevant requirements of the Convention, and this certificate shall, in accordance with regulation I/14(d) of the Convention, be accepted as valid until _____

Signed _____
(signature of authorized official)

Place _____

Date _____

(seal or stamp of the authority, as appropriate)

Endorsement to extend the validity of the certificate until reaching the port of survey or for a period of grace where regulation I/14(e) or I/14(f) applies

This certificate shall, in accordance with regulation I/14(e) / I/14(f)¹ of the Convention, be accepted as valid until _____

Signed _____
(signature of authorized official)

Place _____

Date _____

(seal or stamp of the authority, as appropriate)

¹ Delete as appropriate.

**RECORD OF EQUIPMENT FOR PASSENGER SHIP SAFETY
(FORM P)**

RECORD OF EQUIPMENT FOR COMPLIANCE WITH
THE INTERNATIONAL CONVENTION FOR THE SAFETY
OF LIFE AT SEA, 1974, AS AMENDED

1 Particulars of ship

Name of ship _____

Distinctive number or letters _____

Number of passengers for which certified _____

Minimum number of persons with required qualifications to operate the radio installations _____

2 Details of life-saving appliances

1	Total number of persons for which life-saving appliances are provided		
		Port side	Starboard side
2	Total number of lifeboats		
2.1	Total number of persons accommodated by them		
2.2	Number of partially enclosed lifeboats (regulation III/21 and LSA Code, section 4.5)		
2.3	Number of self-righting partially enclosed lifeboats (regulation III/43) ¹		
2.4	Number of totally enclosed lifeboats (regulation III/21 and LSA Code, section 4.6)		
2.5	Other lifeboats		
2.5.1	Number		
2.5.2	Type		
3	Number of motor lifeboats (included in the total lifeboats shown above)		
3.1	Number of lifeboats fitted with searchlights		
4	Number of rescue boats		
4.1	Number of boats which are included in the total lifeboats shown above		
4.2	Number of boats which are fast rescue boats		
5	Liferafts		
5.1	Those for which approved launching appliances are required		
5.1.1	Number of liferafts		
5.1.2	Number of persons accommodated by them		
5.2	Those for which approved launching appliances are not required		
5.2.1	Number of liferafts		
5.2.2	Number of persons accommodated by them		
6	Number of Marine Evacuation Systems (MES)		
6.1	Number of liferafts served by them		
6.2	Number of persons accommodated by them		
7	Buoyant apparatus		
7.1	Number of apparatus		
7.2	Number of persons capable of being supported		
8	Number of lifebuoys		

¹ Refer to the 1983 amendments to SOLAS (MSC.6(48)), applicable to ships constructed on or after 1 July 1986, but before 1 July 1998.

2 Details of life-saving appliances (continued)

9	Number of lifejackets (total)	
9.1	Number of adult lifejackets	
9.2	Number of child lifejackets	
9.3	Number of infant lifejackets	
10	Immersion suits	
10.1	Total number	
10.2	Number of suits complying with the requirements for lifejackets	
11	Number of anti-exposure suits	
12	Number of thermal protective aids ²	
13	Radio installations used in life-saving appliances	
13.1	Number of search and rescue locating devices	
13.1.1	Radar search and rescue transponders (SART)	
13.1.2	AIS search and rescue transmitters (AIS-SART)	
13.2	Number of two-way VHF radiotelephone apparatus	

3 Details of radio facilities

Item		Actual provision
1	Primary systems	
1.1	VHF radio installation	
1.1.1	DSC encoder	
1.1.2	DSC watch receiver	
1.1.3	Radiotelephony	
1.2	MF radio installation	
1.2.1	DSC encoder	
1.2.2	DSC watch receiver	
1.2.3	Radiotelephony	
1.3	MF/HF radio installation	
1.3.1	DSC encoder	
1.3.2	DSC watch receiver	
1.3.3	Radiotelephony	
1.3.4	Direct-printing radiotelegraphy	
1.4	Recognized mobile satellite service ship earth station	
2	Secondary means of alerting	
3	Facilities for reception of maritime safety information	
3.1	NAVTEX receiver	
3.2	EGC receiver	
3.3	HF direct-printing radiotelegraph receiver	
4	Satellite EPIRB	
4.1	COSPAS-SARSAT	
5	VHF EPIRB	
6	Ship's search and rescue locating device	
6.1	Radar search and rescue transponder (SART)	
6.2	AIS search and rescue transmitter (AIS-SART)	

² Excluding those required by the LSA Code, paragraphs 4.1.5.1.24, 4.4.8.31 and 5.1.2.2.13.

4 Methods used to ensure availability of radio facilities (regulations IV/15.6 and 15.7)

- 4.1 Duplication of equipment _____
- 4.2 Shore-based maintenance _____
- 4.3 At-sea maintenance capability _____

5 Details of navigational systems and equipment

	Item	Actual provision
1.1	Standard magnetic compass	
1.2	Spare magnetic compass ³	
1.3	Gyro-compass ³	
1.4	Gyro-compass heading repeater ³	
1.5	Gyro-compass bearing repeater ³	
1.6	Heading or track control system ³	
1.7	Pelorus or compass bearing device ³	
1.8	Means of correcting heading and bearings	
1.9	Transmitting heading device (THD) ³	
2.1	Nautical charts/electronic chart display and information system (ECDIS) ⁴	
2.2	Back-up arrangements for ECDIS	
2.3	Nautical publications	
2.4	Back-up arrangements for electronic nautical publications	
3.1	Receiver for a global navigation satellite system/terrestrial radionavigation system/multi-system shipborne radionavigation receiver ^{3, 4}	
3.2	9 GHz radar ³	
3.3	Second radar (3 GHz/9 GHz) ³	
3.4	Automatic radar plotting aid (ARPA) ³	
3.5	Automatic tracking aid ³	
3.6	Second automatic tracking aid ³	
3.7	Electronic plotting aid ³	
4.1	Automatic identification system (AIS)	
4.2	Long-range identification and tracking system	
5	Voyage data recorder (VDR)	
6.1	Speed and distance measuring device (through the water) ³	
6.2	Speed and distance measuring device (over the ground in the forward and athwartships direction) ³	
7	Echo-sounding device ³	
8.1	Rudder, propeller, thrust, pitch and operational mode indicator ³	
8.2	Rate-of-turn indicator ³	
9	Sound reception system ³	
10	Telephone to emergency steering position ³	
11	Daylight signalling lamp ³	
12	Radar reflector ³	
13	International Code of Signals	
14	IAMSAR Manual, Volume III	
15	Bridge navigational watch alarm system (BNWAS)	

SEE INTERPRETATION 1

³ Alternative means of meeting this requirement are permitted under regulation V/19. In case of other means, they shall be specified.

⁴ Delete as appropriate.

Form of safety construction certificate for cargo ships

CARGO SHIP SAFETY CONSTRUCTION CERTIFICATE

(official seal)

(State)

Issued under the provisions of the
INTERNATIONAL CONVENTION FOR THE SAFETY OF LIFE AT SEA, 1974,
as modified by the Protocol of 1988 relating thereto

under the authority of the Government of

_____ *(name of the State)*

by _____ *(person or organization authorized)*

Particulars of ship¹

Name of ship _____

Distinctive number or letters _____

Port of registry _____

Gross tonnage _____

Deadweight of ship (metric tons)² _____

IMO Number³ _____

Type of ship⁴

Bulk carrier

Oil tanker

Chemical tanker

Gas carrier

Cargo ship other than any of the above

Date of build

Date of building contract _____

Date on which keel was laid or ship was at similar stage of construction _____

Date of delivery _____

Date on which work for a conversion or an alteration or modification
of a major character was commenced (where applicable) _____

All applicable dates shall be completed.

¹ Alternatively, the particulars of the ship may be placed horizontally in boxes.

² For oil tankers, chemical tankers and gas carriers only.

³ In accordance with the IMO ship identification number scheme (resolution A.1117(30)).

⁴ Delete as appropriate.

THIS IS TO CERTIFY:

- 1 That the ship has been surveyed in accordance with the requirements of regulation I/10 of the Convention.
- 2 That the survey showed that:
 - .1 the condition of the structure, machinery and equipment as defined in the above regulation was satisfactory and the ship complied with the relevant requirements of chapters II-1 and II-2 of the Convention (other than those relating to fire safety systems and appliances and fire control plans); and
 - .2 the ship complied with part G of chapter II-1 of the Convention using as fuel/N.A.⁴
- 3 That the last two inspections of the outside of the ship's bottom took place on _____
and _____ (dd/mm/yyyy)
- 4 That an Exemption Certificate has/has not⁴ been issued.
- 5 The ship was/was not⁴ subjected to an alternative design and arrangements in pursuance of regulation(s) II-1/55 / II-2/17⁴ of the Convention.
- 6 A Document of approval of alternative design and arrangements for machinery and electrical installations/fire protection⁴ is/is not⁴ appended to this Certificate.

This certificate is valid until _____⁵ subject to the annual and intermediate surveys and inspections of the outside of the ship's bottom in accordance with regulation I/10 of the Convention.

Completion date of the survey on which this certificate is based _____ (dd/mm/yyyy)

Issued at _____
(place of issue of the certificate)

(date of issue) (signature of authorized official issuing the certificate)

(seal or stamp of the issuing authority, as appropriate)

⁴ Delete as appropriate.

⁵ Insert the date of expiry as specified by the Administration in accordance with regulation I/14(a) of the Convention. The day and the month of this date correspond to the anniversary date, as defined in regulation I/2(n) of the Convention, unless amended in accordance with regulation I/14(h).

**Endorsement to extend the validity of the certificate until reaching the port of survey
or for a period of grace where regulation I/14(e) or I/14(f) applies**

The certificate shall, in accordance with regulation I/14(e) / I/14(f)⁴ of the Convention, be accepted as valid until

Signed _____
(signature of authorized official)

Place _____

Date _____

(seal or stamp of the authority, as appropriate)

Endorsement for advancement of anniversary date where regulation I/14(h) applies

In accordance with regulation I/14(h) of the Convention, the new anniversary date is _____

Signed _____
(signature of authorized official)

Place _____

Date _____

(seal or stamp of the authority, as appropriate)

In accordance with regulation I/14(h) of the Convention, the new anniversary date is _____

Signed _____
(signature of authorized official)

Place _____

Date _____

(seal or stamp of the authority, as appropriate)

⁴ Delete as appropriate.

Form of safety equipment certificate for cargo ships

CARGO SHIP SAFETY EQUIPMENT CERTIFICATE

This Certificate shall be supplemented by a Record of Equipment for Cargo Ship Safety (Form E)

(official seal)

(State)

Issued under the provisions of the
INTERNATIONAL CONVENTION FOR THE SAFETY OF LIFE AT SEA, 1974,
as modified by the Protocol of 1988 relating thereto

under the authority of the Government of

_____ *(name of the State)*

by _____
(person or organization authorized)

Particulars of ship¹

Name of ship _____

Distinctive number or letters _____

Port of registry _____

Gross tonnage _____

Deadweight of ship (metric tons)² _____

Length of ship (regulation III/3.12) _____

IMO Number³ _____

Type of ship⁴

Bulk carrier

Oil tanker

Chemical tanker

Gas carrier

Cargo ship other than any of the above

Date on which keel was laid or ship was at a similar stage of construction or, where applicable, date on which work for a conversion or an alteration or modification of a major character was commenced _____

¹ Alternatively, the particulars of the ship may be placed horizontally in boxes.

² For oil tankers, chemical tankers and gas carriers only.

³ In accordance with the IMO ship identification number scheme (resolution A.1117(30)).

⁴ Delete as appropriate.

THIS IS TO CERTIFY:

- 1 That the ship has been surveyed in accordance with the requirements of regulation I/8 of the Convention.
- 2 That the survey showed that:
 - 2.1 the ship complied with the requirements of the Convention as regards fire safety systems and appliances and fire control plans;
 - 2.2 the life-saving appliances and the equipment of the lifeboats, liferafts and rescue boats were provided in accordance with the requirements of the Convention;
 - 2.3 the ship was provided with a line-throwing appliance and radio installations used in life-saving appliances in accordance with the requirements of the Convention;
 - 2.4 the ship complied with the requirements of the Convention as regards shipborne navigational equipment, means of embarkation for pilots and nautical publications;
 - 2.5 the ship was provided with lights, shapes and means of making sound signals and distress signals in accordance with the requirements of the Convention and the International Regulations for Preventing Collisions at Sea in force;
 - 2.6 in all other respects the ship complied with the relevant requirements of the Convention;
 - 2.7 the ship was/was not⁴ subjected to an alternative design and arrangements in pursuance of regulation(s) II-2/17 / III/38⁴ of the Convention;
 - 2.8 a Document of approval of alternative design and arrangements for fire protection/life-saving appliances and arrangements⁴ is/is not⁴ appended to this Certificate.
- 3 That the ship operates in accordance with regulation III/26.1.1.1⁵ within the limits of the trade area _____
- 4 That an Exemption Certificate has/has not⁴ been issued.

This certificate is valid until _____⁶ subject to the annual and periodical surveys in accordance with regulation I/8 of the Convention.

Completion date of the survey on which this certificate is based _____ (dd/mm/yyyy)

Issued at _____
(place of issue of the certificate)

(date of issue)

(signature of authorized official
issuing the certificate)

(seal or stamp of the issuing authority, as appropriate)

⁴ Delete as appropriate.

⁵ Refer to the 1983 amendments to SOLAS (MSC.6(48)), applicable to ships constructed on or after 1 July 1986, but before 1 July 1998 in the case of self-righting partially enclosed lifeboats on board.

⁶ Insert the date of expiry as specified by the Administration in accordance with regulation I/14(a) of the Convention. The day and the month of this date correspond to the anniversary date, as defined in regulation I/2(n) of the Convention, unless amended in accordance with regulation I/14(h).

Endorsement for annual and periodical surveys

THIS IS TO CERTIFY that, at a survey required by regulation I/8 of the Convention, the ship was found to comply with the relevant requirements of the Convention.

Annual survey
Signed _____
(signature of authorized official)
Place _____
Date _____

(seal or stamp of the authority, as appropriate)

Annual/periodical⁴ survey
Signed _____
(signature of authorized official)
Place _____
Date _____

(seal or stamp of the authority, as appropriate)

Annual/periodical⁴ survey
Signed _____
(signature of authorized official)
Place _____
Date _____

(seal or stamp of the authority, as appropriate)

Annual survey
Signed _____
(signature of authorized official)
Place _____
Date _____

(seal or stamp of the authority, as appropriate)

Annual/periodical survey in accordance with regulation I/14(h)(iii)

THIS IS TO CERTIFY that, at an annual/a periodical survey⁴ in accordance with regulation I/14(h)(iii) of the Convention, this ship was found to comply with the relevant requirements of the Convention.

Signed _____
(signature of authorized official)
Place _____
Date _____

(seal or stamp of the authority, as appropriate)

⁴ Delete as appropriate.

Endorsement to extend the certificate if valid for less than five years where regulation I/14(c) applies

The ship complies with the relevant requirements of the Convention, and this certificate shall, in accordance with regulation I/14(c) of the Convention, be accepted as valid until _____

Signed _____
(signature of authorized official)

Place _____

Date _____

(seal or stamp of the authority, as appropriate)

Endorsement where the renewal survey has been completed and regulation I/14(d) applies

The ship complies with the relevant requirements of the Convention, and this certificate shall, in accordance with regulation I/14(d) of the Convention, be accepted as valid until _____

Signed _____
(signature of authorized official)

Place _____

Date _____

(seal or stamp of the authority, as appropriate)

Endorsement to extend the validity of the certificate until reaching the port of survey or for a period of grace where regulation I/14(e) or I/14(f) applies

The certificate shall, in accordance with regulation I/14(e) / I/14(f)⁴ of the Convention, be accepted as valid until _____

Signed _____
(signature of authorized official)

Place _____

Date _____

(seal or stamp of the authority, as appropriate)

⁴ Delete as appropriate.

Endorsement for advancement of anniversary date where regulation I/14(h) applies

In accordance with regulation I/14(h) of the Convention, the new anniversary date is _____

Signed _____
(signature of authorized official)

Place _____

Date _____

(seal or stamp of the authority, as appropriate)

In accordance with regulation I/14(h) of the Convention, the new anniversary date is _____

Signed _____
(signature of authorized official)

Place _____

Date _____

(seal or stamp of the authority, as appropriate)

**RECORD OF EQUIPMENT FOR CARGO SHIP SAFETY
(FORM E)**

RECORD OF EQUIPMENT FOR COMPLIANCE WITH
THE INTERNATIONAL CONVENTION FOR THE SAFETY
OF LIFE AT SEA, 1974, AS AMENDED

1 Particulars of ship

Name of ship _____

Distinctive number or letters _____

2 Details of life-saving appliances

1	Total number of persons for which life-saving appliances are provided		
		Port side	Starboard side
2	Total number of davit-launched lifeboats		
2.1	Total number of persons accommodated by them		
2.2	Number of self-righting partially enclosed lifeboats (regulation III/43) ¹		
2.3	Number of totally enclosed lifeboats (regulation III/31 and LSA Code, section 4.6)		
2.4	Number of lifeboats with a self-contained air support system (regulation III/31 and LSA Code, section 4.8)		
2.5	Number of fire-protected lifeboats (regulation III/31 and LSA Code, section 4.9)		
2.6	Other lifeboats		
2.6.1	Number		
2.6.2	Type		
3	Total number of free-fall lifeboats		
3.1	Total number of persons accommodated by them		
3.2	Number of totally enclosed lifeboats (regulation III/31 and LSA Code, section 4.7)		
3.3	Number of lifeboats with a self-contained air support system (regulation III/31 and LSA Code, section 4.8)		
3.4	Number of fire-protected lifeboats (regulation III/31 and LSA Code, section 4.9)		
4	Number of motor lifeboats (included in the total lifeboats shown in 2 and 3 above)		
4.1	Number of lifeboats fitted with searchlights		
5	Number of rescue boats		
5.1	Number of boats which are included in the total lifeboats shown in 2 and 3 above		
6	Liferafts		
6.1	Those for which approved launching appliances are required		
6.1.1	Number of liferafts		
6.1.2	Number of persons accommodated by them		
6.2	Those for which approved launching appliances are not required		
6.2.1	Number of liferafts		
6.2.2	Number of persons accommodated by them		
6.3	Number of liferafts required by regulation III/31.1.4		
7	Number of lifebuoys		
8	Number of lifejackets		
9	Immersion suits		

¹ Refer to the 1983 amendments to SOLAS (MSC.6(48)), applicable to ships constructed on or after 1 July 1986, but before 1 July 1998.

2 Details of life-saving appliances (continued)

9.1	Total number	
9.2	Number of suits complying with the requirements for lifejackets	
10	Number of anti-exposure suits	
11	Radio installations used in life-saving appliances	
11.1	Number of search and rescue locating devices	
11.1.1	Radar search and rescue transponders (SART)	
11.1.2	AIS search and rescue transmitters (AIS-SART)	
11.2	Number of two-way VHF radiotelephone apparatus	

3 Details of navigational systems and equipment

	Item	Actual provision
1.1	Standard magnetic compass ²	
1.2	Spare magnetic compass ²	
1.3	Gyro-compass ²	
1.4	Gyro-compass heading repeater ²	
1.5	Gyro-compass bearing repeater ²	
1.6	Heading or track control system ²	
1.7	Pelorus or compass bearing device ²	
1.8	Means of correcting heading and bearings	
1.9	Transmitting heading device (THD) ²	
2.1	Nautical charts/Electronic chart display and information system (ECDIS) ³	
2.2	Back-up arrangements for ECDIS	
2.3	Nautical publications	
2.4	Back-up arrangements for electronic nautical publications	
3.1	Receiver for a global navigation satellite system/terrestrial radionavigation system/multi-system shipborne radionavigation receiver ^{2, 3}	
3.2	9 GHz radar ²	
3.3	Second radar (3 GHz/9 GHz) ³ ²	
3.4	Automatic radar plotting aid (ARPA) ²	
3.5	Automatic tracking aid ²	
3.6	Second automatic tracking aid ²	
3.7	Electronic plotting aid ²	
4.1	Automatic identification system (AIS)	
4.2	Long-range identification and tracking system	
5.1	Voyage data recorder (VDR) ³	
5.2	Simplified voyage data recorder (S-VDR) ³	
6.1	Speed and distance measuring device (through the water) ²	
6.2	Speed and distance measuring device (over the ground in the forward and athwartships direction) ²	
7	Echo-sounding device ²	

SEE INTERPRETATION 1

² Alternative means of meeting this requirement are permitted under regulation V/19. In case of other means, they shall be specified.

³ Delete as appropriate.

3 Details of navigational systems and equipment (continued)

Item		Actual provision
8.1	Rudder, propeller, thrust, pitch and operational mode indicator ²	
8.2	Rate-of-turn indicator ²	
9	Sound reception system ²	
10	Telephone to emergency steering position ²	
11	Daylight signalling lamp ²	
12	Radar reflector ²	
13	International Code of Signals	
14	IAMSAR Manual, Volume III	
15	Bridge navigational watch alarm system (BNWAS)	

THIS IS TO CERTIFY that this Record is correct in all respects.

Issued at _____
(place of issue of the Record)

_____ (date of issue) _____ (signature of duly authorized official issuing the Record)

(seal or stamp of the issuing authority, as appropriate)

² Alternative means of meeting this requirement are permitted under regulation V/19. In case of other means, they shall be specified.

³ Delete as appropriate.

Form of safety radio certificate for cargo ships

CARGO SHIP SAFETY RADIO CERTIFICATE

This Certificate shall be supplemented by a Record of Equipment for Cargo Ship Safety Radio (Form R)

(official seal)

(State)

Issued under the provisions of the
INTERNATIONAL CONVENTION FOR THE SAFETY OF LIFE AT SEA, 1974,
as modified by the Protocol of 1988 relating thereto

under the authority of the Government of

_____ *(name of the State)*

by _____
(person or organization authorized)

Particulars of ship¹

Name of ship _____

Distinctive number or letters _____

Port of registry _____

Gross tonnage _____

Sea areas in which ship is certified to operate (regulation IV/2) _____

IMO Number² _____

Date on which keel was laid or ship was at a similar stage of construction or, where applicable, date on which work for a conversion or an alteration or modification of a major character was commenced _____

¹ Alternatively, the particulars of the ship may be placed horizontally in boxes.

² In accordance with the IMO ship identification number scheme (resolution A.1117(30)).

THIS IS TO CERTIFY:

- 1 That the ship has been surveyed in accordance with the requirements of regulation I/9 of the Convention.
- 2 That the survey showed that:
 - 2.1 the ship complied with the requirements of the Convention as regards radio installations;
 - 2.2 the functioning of the radio installations used in life-saving appliances complied with the requirements of the Convention.
- 3 That an Exemption Certificate has/~~has not~~³ been issued.

This certificate is valid until _____⁴ subject to the periodical surveys in accordance with regulation I/9 of the Convention.

Completion date of the survey on which this certificate is based _____ (dd/mm/yyyy)

Issued at _____
(place of issue of the certificate)

(date of issue) (signature of duly authorized official issuing the certificate)

(seal or stamp of the issuing authority, as appropriate)

³ Delete as appropriate.

⁴ Insert the date of expiry as specified by the Administration in accordance with regulation I/14(a) of the Convention. The day and the month of this date correspond to the anniversary date, as defined in regulation I/2(n) of the Convention, unless amended in accordance with regulation I/14(h).

Endorsement for periodical surveys

THIS IS TO CERTIFY that, at a survey required by regulation I/9 of the Convention, the ship was found to comply with the relevant requirements of the Convention.

Periodical survey Signed _____
(signature of authorized official)
Place _____
Date _____

(seal or stamp of the authority, as appropriate)

Periodical survey Signed _____
(signature of authorized official)
Place _____
Date _____

(seal or stamp of the authority, as appropriate)

Periodical survey Signed _____
(signature of authorized official)
Place _____
Date _____

(seal or stamp of the authority, as appropriate)

Periodical survey Signed _____
(signature of authorized official)
Place _____
Date _____

(seal or stamp of the authority, as appropriate)

Periodical survey in accordance with regulation I/14(h)(iii)

THIS IS TO CERTIFY that, at a periodical survey in accordance with regulation I/14(h)(iii) of the Convention, the ship was found to comply with the relevant requirements of the Convention.

Signed _____
(signature of authorized official)
Place _____
Date _____

(seal or stamp of the authority, as appropriate)

Endorsement to extend the certificate if valid for less than five years where regulation I/14(c) applies

The ship complies with the relevant requirements of the Convention, and this certificate shall, in accordance with regulation I/14(c) of the Convention, be accepted as valid until _____

Signed _____
(signature of authorized official)

Place _____

Date _____

(seal or stamp of the authority, as appropriate)

Endorsement where the renewal survey has been completed and regulation I/14(d) applies

The ship complies with the relevant requirements of the Convention, and this certificate shall, in accordance with regulation I/14(d) of the Convention, be accepted as valid until _____

Signed _____
(signature of authorized official)

Place _____

Date _____

(seal or stamp of the authority, as appropriate)

Endorsement to extend the validity of the certificate until reaching the port of survey or for a period of grace where regulation I/14(e) or I/14(f) applies

The certificate shall, in accordance with regulation I/14(e) / I/14(f)³ of the Convention, be accepted as valid until _____

Signed _____
(signature of authorized official)

Place _____

Date _____

(seal or stamp of the authority, as appropriate)

³ Delete as appropriate.

Endorsement for advancement of anniversary date where regulation I/14(h) applies

In accordance with regulation I/14(h) of the Convention, the new anniversary date is _____

Signed _____
(signature of authorized official)

Place _____

Date _____

(seal or stamp of the authority, as appropriate)

In accordance with regulation I/14(h) of the Convention, the new anniversary date is _____

Signed _____
(signature of authorized official)

Place _____

Date _____

(seal or stamp of the authority, as appropriate)

**RECORD OF EQUIPMENT FOR CARGO SHIP SAFETY RADIO
(FORM R)**

RECORD OF EQUIPMENT FOR COMPLIANCE WITH
THE INTERNATIONAL CONVENTION FOR THE SAFETY
OF LIFE AT SEA, 1974, AS AMENDED

1 Particulars of ship

Name of ship _____

Distinctive number or letters _____

Minimum number of persons with required qualifications to operate the radio installations _____

2 Details of radio facilities

Item		Actual provision
1	Primary systems	
1.1	VHF radio installation	
1.1.1	DSC encoder	
1.1.2	DSC watch receiver	
1.1.3	Radiotelephony	
1.2	MF radio installation	
1.2.1	DSC encoder	
1.2.2	DSC watch receiver	
1.2.3	Radiotelephony	
1.3	MF/HF radio installation	
1.3.1	DSC encoder	
1.3.2	DSC watch receiver	
1.3.3	Radiotelephony	
1.3.4	Direct-printing telegraphy	
1.4	Recognized mobile satellite service ship earth station	
2	Secondary means of alerting	
3	Facilities for reception of maritime safety information	
3.1	NAVTEX receiver	
3.2	EGC receiver	
3.3	HF direct-printing radiotelegraph receiver	
4	Satellite EPIRB	
4.1	COSPAS-SARSAT	
5	VHF EPIRB	
6	Ship's search and rescue locating device	
6.1	Radar search and rescue transponder (SART)	
6.2	AIS search and rescue transmitter (AIS-SART)	

3 Methods used to ensure availability of radio facilities (regulations IV/15.6 and 15.7)

3.1 Duplication of equipment _____

3.2 Shore-based maintenance _____

3.3 At-sea maintenance capability _____

Form of safety certificate for cargo ships

CARGO SHIP SAFETY CERTIFICATE

This Certificate shall be supplemented by a Record of Equipment for Cargo Ship Safety (Form C)

(official seal)

(State)

Issued under the provisions of the
INTERNATIONAL CONVENTION FOR THE SAFETY OF LIFE AT SEA, 1974,
as modified by the Protocol of 1988 relating thereto

under the authority of the Government of

_____ *(name of the State)*

by _____
(person or organization authorized)

Particulars of ship¹

Name of ship _____

Distinctive number or letters _____

Port of registry _____

Gross tonnage _____

Deadweight of ship (metric tons)² _____

Length of ship (regulation III/3.12) _____

Sea areas in which ship is certified to operate (regulation IV/2) _____

IMO Number³ _____

Type of ship⁴

Bulk carrier

Oil tanker

Chemical tanker

Gas carrier

Cargo ship other than any of the above

Date of build

Date of building contract _____

Date on which keel was laid or ship was at similar stage of construction _____

Date of delivery _____

Date on which work for a conversion or an alteration or modification of a major character was commenced
(where applicable) _____

All applicable dates shall be completed.

¹ Alternatively, the particulars of the ship may be placed horizontally in boxes.

² For oil tankers, chemical tankers and gas carriers only.

³ In accordance with the IMO ship identification number scheme (resolution A.1117(30)).

⁴ Delete as appropriate.

THIS IS TO CERTIFY:

- 1 That the ship has been surveyed in accordance with the requirements of regulations I/8, I/9 and I/10 of the Convention.
- 2 That the survey showed that:
 - 2.1 the condition of the structure, machinery and equipment as defined in regulation I/10 was satisfactory and the ship complied with the relevant requirements of chapter II-1 and chapter II-2 of the Convention (other than those relating to fire safety systems and appliances and fire control plans);
 - 2.2 the ship complied with part G of chapter II-1 of the Convention using _____ as fuel/N.A.⁴;
 - 2.3 the last two inspections of the outside of the ship's bottom took place on _____ and _____ (dates);
 - 2.4 the ship complied with the requirements of the Convention as regards fire safety systems and appliances and fire control plans;
 - 2.5 the life-saving appliances and the equipment of the lifeboats, liferafts and rescue boats were provided in accordance with the requirements of the Convention;
 - 2.6 the ship was provided with a line-throwing appliance and radio installations used in life-saving appliances in accordance with the requirements of the Convention;
 - 2.7 the ship complied with the requirements of the Convention as regards radio installations;
 - 2.8 the functioning of the radio installations used in life-saving appliances complied with the requirements of the Convention;
 - 2.9 the ship complied with the requirements of the Convention as regards shipborne navigational equipment, means of embarkation for pilots and nautical publications;
 - 2.10 the ship was provided with lights, shapes, means of making sound signals and distress signals in accordance with the requirements of the Convention and the International Regulations for Preventing Collisions at Sea in force;
 - 2.11 in all other respects the ship complied with the relevant requirements of the Convention;
 - 2.12 the ship was/was not⁴ subjected to an alternative design and arrangements in pursuance of regulation(s) II-1/55 / II-2/17 / III/38⁴ of the Convention;
 - 2.13 a Document of approval of alternative design and arrangements for machinery and electrical installations/fire protection/life-saving appliances and arrangements⁴ is/is not⁴ appended to this Certificate.
- 3 That the ship operates in accordance with regulation III/26.1.1.1⁵ within the limits of the trade area _____
- 4 That an Exemption Certificate has/has not⁴ been issued.

⁴ Delete as appropriate.

⁵ Refer to the 1983 amendments to SOLAS (MSC.6(48)), applicable to ships constructed on or after 1 July 1986, but before 1 July 1998 in the case of self-righting partially enclosed lifeboat(s) on board.

Appendix
Certificates

This certificate is valid until _____⁶ subject to the annual, intermediate and periodical surveys and inspections of the outside of the ship's bottom in accordance with regulations I/8, I/9 and I/10 of the Convention.

Completion date of the survey on which this certificate is based _____ (dd/mm/yyyy)

Issued at _____
(place of issue of the certificate)

(date of issue)

(signature of duly authorized official
issuing the certificate)

(seal or stamp of the issuing authority, as appropriate)

⁶ Insert the date of expiry as specified by the Administration in accordance with regulation I/14(a) of the Convention. The day and the month of this date correspond to the anniversary date as defined in regulation I/2(n) of the Convention, unless amended in accordance with regulation I/14(h).

Endorsement for annual and intermediate surveys relating to structure, machinery and equipment referred to in paragraph 2.1 of this certificate

THIS IS TO CERTIFY that, at a survey required by regulation I/10 of the Convention, the ship was found to comply with the relevant requirements of the Convention.

Annual survey
Signed _____
(signature of authorized official)
Place _____
Date _____

(seal or stamp of the authority, as appropriate)

Annual/intermediate⁴ survey
Signed _____
(signature of authorized official)
Place _____
Date _____

(seal or stamp of the authority, as appropriate)

Annual/intermediate⁴ survey
Signed _____
(signature of authorized official)
Place _____
Date _____

(seal or stamp of the authority, as appropriate)

Annual survey
Signed _____
(signature of authorized official)
Place _____
Date _____

(seal or stamp of the authority, as appropriate)

⁴ Delete as appropriate.

Annual/intermediate survey in accordance with regulation I/14(h)(iii)

THIS IS TO CERTIFY that, at an annual/intermediate⁴ survey in accordance with regulations I/10 and I/14(h)(iii) of the Convention, the ship was found to comply with the relevant requirements of the Convention.

Signed _____
(signature of authorized official)

Place _____

Date _____

(seal or stamp of the authority, as appropriate)

Endorsement for inspections of the outside of the ship's bottom⁷

THIS IS TO CERTIFY that, at an inspection required by regulation I/10 of the Convention, the ship was found to comply with the relevant requirements of the Convention.

First inspection

Signed _____
(signature of authorized official)

Place _____

Date _____

(seal or stamp of the authority, as appropriate)

Second inspection

Signed _____
(signature of authorized official)

Place _____

Date _____

(seal or stamp of the authority, as appropriate)

⁴ Delete as appropriate.

⁷ Provision may be made for additional inspections.

Endorsement for annual and periodical surveys relating to life-saving appliances and other equipment referred to in paragraphs 2.3, 2.4, 2.5, 2.8 and 2.9 of this certificate

THIS IS TO CERTIFY that, at a survey required by regulation I/8 of the Convention, the ship was found to comply with the relevant requirements of the Convention.

Annual survey
Signed _____
(signature of authorized official)
Place _____
Date _____

(seal or stamp of the authority, as appropriate)

Annual/periodical⁴ survey
Signed _____
(signature of authorized official)
Place _____
Date _____

(seal or stamp of the authority, as appropriate)

Annual/periodical⁴ survey
Signed _____
(signature of authorized official)
Place _____
Date _____

(seal or stamp of the authority, as appropriate)

Annual survey
Signed _____
(signature of authorized official)
Place _____
Date _____

(seal or stamp of the authority, as appropriate)

⁴ Delete as appropriate.

Annual/periodical survey in accordance with regulation I/14(h)(iii)

THIS IS TO CERTIFY that, at an annual/periodical⁴ survey in accordance with regulations I/8 and I/14(h)(iii) of the Convention, the ship was found to comply with the relevant requirements of the Convention.

Signed _____
(signature of authorized official)

Place _____

Date _____

(seal or stamp of the authority, as appropriate)

Endorsement for periodical surveys relating to radio installations referred to in paragraphs 2.6 and 2.7 of this certificate

THIS IS TO CERTIFY that, at a survey required by regulation I/9 of the Convention, the ship was found to comply with the relevant requirements of the Convention.

Periodical survey

Signed _____
(signature of authorized official)

Place _____

Date _____

(seal or stamp of the authority, as appropriate)

Periodical survey

Signed _____
(signature of authorized official)

Place _____

Date _____

(seal or stamp of the authority, as appropriate)

Periodical survey

Signed _____
(signature of authorized official)

Place _____

Date _____

(seal or stamp of the authority, as appropriate)

Periodical survey

Signed _____
(signature of authorized official)

Place _____

Date _____

(seal or stamp of the authority, as appropriate)

⁴ Delete as appropriate.

Periodical survey in accordance with regulation I/14(h)(iii)

THIS IS TO CERTIFY that, at a periodical survey in accordance with regulations I/9 and I/14(h)(iii) of the Convention, the ship was found to comply with the relevant requirements of the Convention.

Signed _____
(signature of authorized official)

Place _____

Date _____

(seal or stamp of the authority, as appropriate)

Endorsement to extend the certificate if valid for less than five years where regulation I/14(c) applies

The ship complies with the relevant requirements of the Convention, and this certificate shall, in accordance with regulation I/14(c) of the Convention, be accepted as valid until _____

Signed _____
(signature of authorized official)

Place _____

Date _____

(seal or stamp of the authority, as appropriate)

Endorsement where the renewal survey has been completed and regulation I/14(d) applies

The ship complies with the relevant requirements of the Convention, and this certificate shall, in accordance with regulation I/14(d) of the Convention, be accepted as valid until _____

Signed _____
(signature of authorized official)

Place _____

Date _____

(seal or stamp of the authority, as appropriate)

**Endorsement to extend the validity of the certificate until reaching the port of survey
or for a period of grace where regulation I/14(e) or I/14(f) applies**

The certificate shall, in accordance with regulation I/14(e) / I/14(f)⁴ of the Convention, be accepted as valid until

Signed _____
(signature of authorized official)

Place _____

Date _____

(seal or stamp of the authority, as appropriate)

Endorsement for advancement of anniversary date where regulation I/14(h) applies

In accordance with regulation I/14(h) of the Convention, the new anniversary date is _____

Signed _____
(signature of authorized official)

Place _____

Date _____

(seal or stamp of the authority, as appropriate)

In accordance with regulation I/14(h) of the Convention, the new anniversary date is _____

Signed _____
(signature of authorized official)

Place _____

Date _____

(seal or stamp of the authority, as appropriate)

⁴ Delete as appropriate.

Form of exemption certificate

EXEMPTION CERTIFICATE

(official seal)

(State)

Issued under the provisions of the
INTERNATIONAL CONVENTION FOR THE SAFETY OF LIFE AT SEA, 1974,
as modified by the Protocol of 1988 relating thereto

under the authority of the Government of

_____ *(name of the State)*

by _____
(person or organization authorized)

Particulars of ship¹

Name of ship _____

Distinctive number or letters _____

Port of registry _____

Gross tonnage _____

IMO Number² _____

¹ Alternatively, the particulars of the ship may be placed horizontally in boxes.

² In accordance with the IMO ship identification number scheme (resolution A.1117(30)).

Appendix
Certificates

THIS IS TO CERTIFY:

That the ship is, under the authority conferred by regulation _____ of the Convention, exempted from the requirements _____ of the Convention.

Conditions, if any, on which the Exemption Certificate is granted _____

Voyages, if any, for which the Exemption Certificate is granted _____

This certificate is valid until _____ subject to the _____ Certificate, to which this certificate is attached, remaining valid.

Issued at _____
(place of issue of the certificate)

(date of issue)

*(signature of duly authorized official
issuing the certificate)*

(seal or stamp of the issuing authority, as appropriate)

Endorsement to extend the certificate if valid for less than five years where regulation I/14(c) applies

This certificate shall, in accordance with regulation I/14(c) of the Convention, be accepted as valid until _____
subject to the _____ Certificate, to which this certificate is attached, remaining valid.

Signed _____
(signature of authorized official)

Place _____

Date _____

(seal or stamp of the authority, as appropriate)

Endorsement where the renewal survey has been completed and regulation I/14(d) applies

This certificate shall, in accordance with regulation I/14(d) of the Convention, be accepted as valid until _____
subject to the _____ Certificate, to which this certificate is attached, remaining valid.

Signed _____
(signature of authorized official)

Place _____

Date _____

(seal or stamp of the authority, as appropriate)

Endorsement to extend the validity of the certificate until reaching the port of survey or for a period of grace where regulation I/14(e) or I/14(f) applies

This certificate shall, in accordance with regulation I/14(e) / I/14(f)³ of the Convention, be accepted as valid
until _____ subject to the _____ Certificate, to which this certificate is
attached, remaining valid.

Signed _____
(signature of authorized official)

Place _____

Date _____

(seal or stamp of the authority, as appropriate)

³ Delete as appropriate.

Form of safety certificate for nuclear passenger ships

NUCLEAR PASSENGER SHIP SAFETY CERTIFICATE

This Certificate shall be supplemented by a Record of Equipment for Passenger Ship Safety (Form P)

(official seal)

(State)

for an/a short¹ international voyage

Issued under the provisions of the
INTERNATIONAL CONVENTION FOR THE SAFETY OF LIFE
AT SEA, 1974, as amended

under the authority of the Government of

(name of the State)

by _____

(person or organization authorized)

Particulars of ship²

Name of ship _____

Distinctive number or letters _____

Port of registry _____

Gross tonnage _____

Sea areas in which ship is certified to operate (regulation IV/2) _____

IMO Number³ _____

Date of build

Date of building contract _____

Date on which keel was laid or ship was at similar stage of construction _____

Date of delivery _____

Date on which work for a conversion or an alteration or modification
of a major character was commenced (where applicable) _____

All applicable dates shall be completed.

¹ Delete as appropriate.

² Alternatively, the particulars of the ship may be placed horizontally in boxes.

³ In accordance with the IMO ship identification number scheme (resolution A.1117(30)).

THIS IS TO CERTIFY:

- 1 That the ship has been surveyed in accordance with the requirements of regulation VIII/9 of the Convention.
- 2 That the ship, being a nuclear ship, complied with all the requirements of chapter VIII of the Convention and conformed to the Safety Assessment approved for the ship; and that:
 - 2.1 the ship complied with the requirements of the Convention as regards:
 - .1 the structure, main and auxiliary machinery, boilers and other pressure vessels, including the nuclear propulsion plant and the collision protective structure;
 - .2 the watertight subdivision arrangements and details;
 - .3 the following subdivision load lines:

Subdivision load lines assigned and marked on the ship's side amidships (regulation II-1/18) ⁴	Freeboard	To apply when the spaces in which passengers are carried include the following alternative spaces
P1		
P2		
P3		

- 2.2 the ship complied with the requirements of the Convention as regards structural fire protection, fire safety systems and appliances and fire control plans;
- 2.3 the ship complied with the requirements of the Convention as regards radiation protection systems and equipment;
- 2.4 the life-saving appliances and the equipment of the lifeboats, liferafts and rescue boats were provided in accordance with the requirements of the Convention;
- 2.5 the ship was provided with a line-throwing appliance and radio installations used in life-saving appliances in accordance with the requirements of the Convention;
- 2.6 the ship complied with the requirements of the Convention as regards radio installations;
- 2.7 the functioning of the radio installations used in life-saving appliances complied with the requirements of the Convention;
- 2.8 the ship complied with the requirements of the Convention as regards shipborne navigational equipment, means of embarkation for pilots and nautical publications;
- 2.9 the ship was provided with lights, shapes, means of making sound signals and distress signals, in accordance with the requirements of the Convention and the International Regulations for Preventing Collisions at Sea in force;
- 2.10 in all other respects the ship complied with the relevant requirements of the Convention;
- 2.11 the ship was/was not¹ subjected to an alternative design and arrangements in pursuance of regulation(s) II-1/55 / II-2/17 / III/38¹ of the Convention;
- 2.12 a Document of approval of alternative design and arrangements for machinery and electrical installations/fire protection/life-saving appliances and arrangements¹ is/is not¹ appended to this Certificate.

¹ Delete as appropriate.

⁴ For ships constructed before 1 January 2009, the applicable subdivision notation "C.1", "C.2" and "C.3" should be used.

Appendix
Certificates

This certificate is valid until _____

Completion date of the survey on which this certificate is based _____ (dd/mm/yyyy)

Issued at _____
(place of issue of certificate)

(date of issue)

(signature of duly authorized official
issuing the certificate)

(seal or stamp of the issuing authority, as appropriate)

Form of safety certificate for nuclear cargo ships

NUCLEAR CARGO SHIP SAFETY CERTIFICATE

This Certificate shall be supplemented by a Record of Equipment for Cargo Ship Safety (Form C)

(official seal)

(State)

Issued under the provisions of the
INTERNATIONAL CONVENTION FOR THE SAFETY OF LIFE
AT SEA, 1974, as amended

under the authority of the Government of

_____ *(name of the State)*

by _____

(person or organization authorized)

Particulars of ship¹

Name of ship _____

Distinctive number or letters _____

Port of registry _____

Gross tonnage _____

Deadweight of ship (metric tons)² _____

Length of ship (regulation III/3.12) _____

Sea areas in which ship is certified to operate (regulation IV/2) _____

IMO Number³ _____

Type of ship⁴

Bulk carrier

Oil tanker

Chemical tanker

Gas carrier

Cargo ship other than any of the above

Date of build

Date of building contract _____

Date on which keel was laid or ship was at similar stage of construction _____

Date of delivery _____

Date on which work for a conversion or an alteration or modification
of a major character was commenced (where applicable) _____

All applicable dates shall be completed.

¹ Alternatively, the particulars of the ship may be placed horizontally in boxes.

² For oil tankers, chemical tankers and gas carriers only.

³ In accordance with the IMO ship identification number scheme (resolution A.1117(30)).

⁴ Delete as appropriate.

THIS IS TO CERTIFY:

- 1 That the ship has been surveyed in accordance with the requirements of regulation VIII/9 of the Convention.
- 2 That the ship, being a nuclear ship, complied with all the requirements of chapter VIII of the Convention and conformed to the Safety Assessment approved for the ship; and that:
 - 2.1 the condition of the structure, machinery and equipment as defined in regulation I/10 (as applicable to comply with regulation VIII/9), including the nuclear propulsion plant and the collision protective structure, was satisfactory and the ship complied with the relevant requirements of chapter II-1 and chapter II-2 of the Convention (other than those relating to fire safety systems and appliances and fire control plans);
 - 2.2 the ship complied with the requirements of the Convention as regards fire safety systems and appliances and fire control plans;
 - 2.3 the life-saving appliances and the equipment of the lifeboats, liferafts and rescue boats were provided in accordance with the requirements of the Convention;
 - 2.4 the ship was provided with a line-throwing appliance and radio installations used in life-saving appliances in accordance with the requirements of the Convention;
 - 2.5 the ship complied with the requirements of the Convention as regards radio installations;
 - 2.6 the functioning of the radio installations used in life-saving appliances complied with the requirements of the Convention;
 - 2.7 the ship complied with the requirements of the Convention as regards shipborne navigational equipment, means of embarkation for pilots and nautical publications;
 - 2.8 the ship was provided with lights, shapes, means of making sound signals and distress signals, in accordance with the requirements of the Convention and the International Regulations for Preventing Collisions at Sea in force;
 - 2.9 in all other respects the ship complied with the relevant requirements of the regulations, so far as these requirements apply thereto;
 - 2.10 the ship was/was not⁴ subjected to an alternative design and arrangements in pursuance of regulation(s) II-1/55 / II-2/17 / III/38⁴ of the Convention;
 - 2.11 a Document of approval of alternative design and arrangements for machinery and electrical installations/fire protection/life-saving appliance and arrangements⁴ is/is not⁴ appended to this Certificate.

This certificate is valid until _____

Completion date of the survey on which this certificate is based _____ (dd/mm/yyyy)

Issued at _____
(place of issue of certificate)

(date of issue)

(signature of authorized official
issuing the certificate)

(seal or stamp of the issuing authority, as appropriate)

⁴ Delete as appropriate.

**RECORD OF EQUIPMENT FOR CARGO SHIP SAFETY
(FORM C)**

RECORD OF EQUIPMENT FOR COMPLIANCE WITH
THE INTERNATIONAL CONVENTION FOR THE SAFETY
OF LIFE AT SEA, 1974, AS AMENDED

1 Particulars of ship

Name of ship _____

Distinctive number or letters _____

Minimum number of persons with required qualifications to operate the radio installations _____

2 Details of life-saving appliances

1	Total number of persons for which life-saving appliances are provided		
		Port side	Starboard side
2	Total number of davit-launched lifeboats		
2.1	Total number of persons accommodated by them		
2.2	Number of self-righting partially enclosed lifeboats (regulation III/43) ¹		
2.3	Number of totally enclosed lifeboats (regulation III/31 and LSA Code, section 4.6)		
2.4	Number of lifeboats with a self-contained air support system (regulation III/31 and LSA Code, section 4.8)		
2.5	Number of fire-protected lifeboats (regulation III/31 and LSA Code, section 4.9)		
2.6	Other lifeboats		
2.6.1	Number		
2.6.2	Type		
3	Total number of free-fall lifeboats		
3.1	Total number of persons accommodated by them		
3.2	Number of totally enclosed lifeboats (regulation III/31 and LSA Code, section 4.7)		
3.3	Number of lifeboats with a self-contained air support system (regulation III/31 and LSA Code, section 4.8)		
3.4	Number of fire-protected lifeboats (regulation III/31 and LSA Code, section 4.9)		
4	Number of motor lifeboats (included in the total lifeboats shown in 2 and 3 above)		
4.1	Number of lifeboats fitted with searchlights		
5	Number of rescue boats		
5.1	Number of boats which are included in the total lifeboats shown in 2 and 3 above		
6	Liferafts		
6.1	Those for which approved launching appliances are required		
6.1.1	Number of liferafts		
6.1.2	Number of persons accommodated by them		

¹ Refer to the 1983 amendments to SOLAS (MSC.6(48)), applicable to ships constructed on or after 1 July 1986, but before 1 July 1998.

2 Details of life-saving appliances (continued)

6.2	Those for which approved launching appliances are not required	
6.2.1	Number of liferafts	
6.2.2	Number of persons accommodated by them	
6.3	Number of liferafts required by regulation III/31.1.4	
7	Number of lifebuoys	
8	Number of lifejackets	
9	Immersion suits	
9.1	Total number	
9.2	Number of suits complying with the requirements for lifejackets	
10	Number of anti-exposure suits	
11	Radio installations used in life-saving appliances	
11.1	Number of search and rescue locating devices	
11.1.1	Radar search and rescue transponders (SART)	
11.1.2	AIS search and rescue transmitters (AIS-SART)	
11.2	Number of two-way VHF radiotelephone apparatus	

3 Details of radio facilities

Item		Actual provision
1	Primary systems	
1.1	VHF radio installation	
1.1.1	DSC encoder	
1.1.2	DSC watch receiver	
1.1.3	Radiotelephony	
1.2	MF radio installation	
1.2.1	DSC encoder	
1.2.2	DSC watch receiver	
1.2.3	Radiotelephony	
1.3	MF/HF radio installation	
1.3.1	DSC encoder	
1.3.2	DSC watch receiver	
1.3.3	Radiotelephony	
1.3.4	Direct-printing telegraphy	
1.4	Recognized mobile satellite service ship earth station	
2	Secondary means of alerting	
3	Facilities for reception of maritime safety information	
3.1	NAVTEX receiver	
3.2	EGC receiver	
3.3	HF direct-printing radiotelegraph receiver	
4	Satellite EPIRB	
4.1	COSPAS-SARSAT	
5	VHF EPIRB	
6	Ship's search and rescue locating device	
6.1	Radar search and rescue transponder (SART)	
6.2	AIS search and rescue transmitter (AIS-SART)	

4 Methods used to ensure availability of radio facilities (regulations IV/15.6 and 15.7)

4.1 Duplication of equipment _____

4.2 Shore-based maintenance _____

4.3 At-sea maintenance capability _____

5 Details of navigational systems and equipment

Item		Actual provision
1.1	Standard magnetic compass ²	
1.2	Spare magnetic compass ²	
1.3	Gyro-compass ²	
1.4	Gyro-compass heading repeater ²	
1.5	Gyro-compass bearing repeater ²	
1.6	Heading or track control system ²	
1.7	Pelorus or compass bearing device ²	
1.8	Means of correcting heading and bearings	
1.9	Transmitting heading device (THD) ²	
2.1	Nautical charts/Electronic chart display and information system (ECDIS) ³	
2.2	Back-up arrangements for ECDIS ⁴	
2.3	Nautical publications	
2.4	Back-up arrangements for electronic nautical publications	
3.1	Receiver for a global navigation satellite system/terrestrial radionavigation system/multi-system shipborne radionavigation receiver ^{2, 3}	
3.2	9 GHz radar ²	
3.3	Second radar (3 GHz/9 GHz ³) ²	
3.4	Automatic radar plotting aid (ARPA) ²	
3.5	Automatic tracking aid ²	
3.6	Second automatic tracking aid ²	
3.7	Electronic plotting aid ²	
4.1	Automatic identification system (AIS)	
4.2	Long-range identification and tracking system	
5.1	Voyage data recorder (VDR) ³	
5.2	Simplified voyage data recorder (S-VDR) ³	
6.1	Speed and distance measuring device (through the water) ²	
6.2	Speed and distance measuring device (over the ground in the forward and athwartships direction) ²	
7	Echo-sounding device ²	
8.1	Rudder, propeller, thrust, pitch and operational mode indicator ²	
8.2	Rate-of-turn indicator ²	
9	Sound reception system ²	

SEE INTERPRETATION 1

² Alternative means of meeting this requirement are permitted under regulation V/19. In case of other means, they shall be specified.³ Delete as appropriate.

Appendix
Certificates

10	Telephone to emergency steering position ²	
11	Daylight signalling lamp ²	
12	Radar reflector ²	
13	International Code of Signals	
14	IAMSAR Manual, Volume III	
15	Bridge navigational watch alarm system (BNWAS)	

THIS IS TO CERTIFY that this record is correct in all respects.

Issued at _____
(place of issue of the Record)

(date of issue)

*(signature of authorized official
issuing the Record)*

(seal or stamp of the issuing authority, as appropriate)

² Alternative means of meeting this requirement are permitted under regulation V/19. In case of other means, they shall be specified.

Unified Interpretations for the Appendix

1 Forms P, E and C

Items 2.1 and 2.2 of Part 3 of the Form E and items 2.1 and 2.2 of Part 5 of Forms P and C shall be completed according to the following scenarios:

1. Nautical Charts only

	Item	Actual provision
2.1	Nautical charts/Electronic chart display and information system (ECDIS)	"Provided"
2.2	Back-up arrangements for ECDIS	"_"

2. Two ECDIS only (no nautical charts)

	Item	Actual provision
2.1	Nautical charts/Electronic chart display and information system (ECDIS)	"Provided"
2.2	Back-up arrangements for ECDIS	"ECDIS"

3. ECDIS + Nautical Charts

	Item	Actual provision
2.1	Nautical charts/Electronic chart display and information system (ECDIS)	"Both provided"
2.2	Back-up arrangements for ECDIS	"ECDIS" or "Nautical Charts"*

* Enter as appropriate

or

	Item	Actual provision
2.1	Nautical charts/Electronic chart display and information system (ECDIS)	"Provided"
2.2	Back-up arrangements for ECDIS	"Nautical Charts"

Notes:

- 1 The ship's management is responsible to determine what form of charts is to be used onboard as the primary means of navigation. Where paper charts are used as the primary means of navigation then they may also be regarded as the ECDIS back-up arrangements.
- 2 Paper charts or ECDIS provided as the "back-up arrangement" may be used alternatively with the primary ECDIS, and not be limited to use only when the primary ECDIS is inoperable.

Part 2

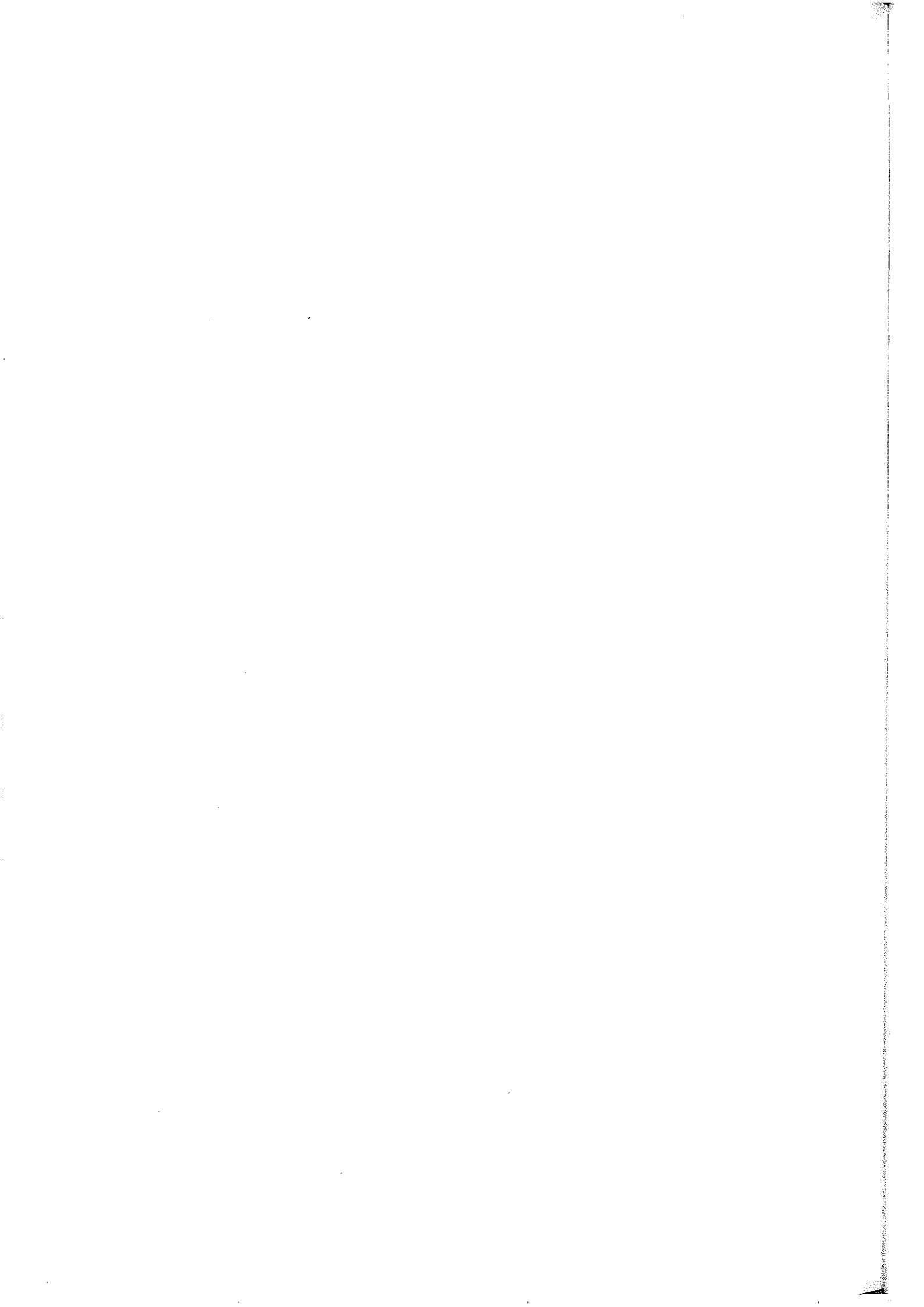

Annexes



Annexes

Annex 1	Certificates and documents required to be carried on board ships	551
Annex 2	List of resolutions adopted by the SOLAS Conferences	573

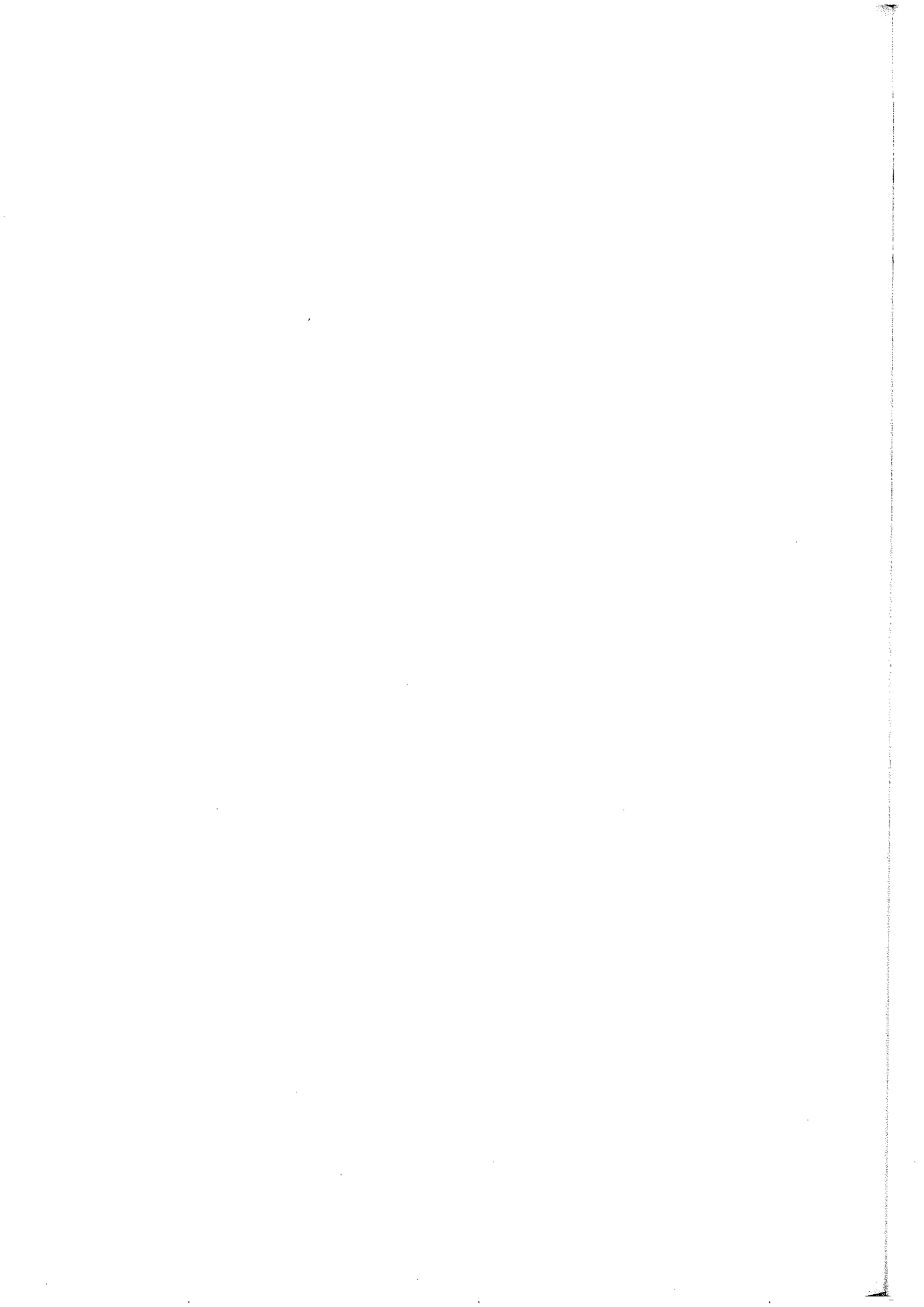

Annex 1

Certificates and documents required to be carried on board ships*

(Note: All certificates to be carried on board must be valid and drawn up in the form corresponding to the model where required by the relevant international convention or instrument.)

Reference

1 All ships to which the referenced convention applies

International Tonnage Certificate (1969)

An International Tonnage Certificate (1969) shall be issued to every ship, the gross and net tonnage of which have been determined in accordance with the Convention.

Tonnage 1969,
article 7

International Load Line Certificate

An International Load Line Certificate shall be issued under the provisions of the International Convention on Load Lines, 1966, to every ship which has been surveyed and marked in accordance with the Convention or the Convention as modified by the 1988 LL Protocol, as appropriate.

LL 1966, article 16;
LL PROT 1988, article 16

International Load Line Exemption Certificate

An International Load Line Exemption Certificate shall be issued to any ship to which an exemption has been granted under and in accordance with article 6 of the Load Line Convention or the Convention as modified by the 1988 LL Protocol, as appropriate.

LL 1966, article 16;
LL PROT 1988, article 16

Exemption Certificate[†]

When an exemption is granted to a ship under and in accordance with the provisions of SOLAS 1974, a certificate called an Exemption Certificate shall be issued in addition to the certificates listed above.

SOLAS 1974, regulation I/12;
SOLAS PROT 1988,
regulation I/12

Coating Technical File

A Coating Technical File, containing specifications of the coating system applied, where applicable, to dedicated seawater ballast tanks in all types of ships and double-side skin spaces of bulk carriers of 150 m in length and upwards and cargo oil tanks of crude oil tankers, record of the shipyard's and shipowner's coating work, detailed criteria for coating sections, job specifications, inspection, maintenance and repair, shall be kept on board and maintained throughout the life of the ship.

SOLAS 1974,
regulation II-1/3-2 and
II-1/3-11;
resolution MSC.215(82),
as amended by
resolution MSC.341(91) and
MSC.1/Circ.1381;
resolution MSC.288(87)
as modified by
circular MSC.1/Circ.1381
and amended by
resolution MSC.342(91)

* Refer to List of certificates and documents required to be carried on board ships, 2017 (FAL.2/Circ.131-MEPC.1/Circ.873-MSC.1/Circ.1586-LEG.2/Circ.3).

[†] Refer to *Issue of Exemption Certificates under the 1974 SOLAS Convention and Amendments thereto* (SLS.14/Circ.115 and its Add.1, Add.2 and Add.3).

Reference

Emergency Towing Procedure

All ships shall be provided with a ship-specific emergency towing procedure. Such a procedure shall be carried on board the ship for use in emergency situations and shall be developed based on the guidelines developed by the Organization.

SOLAS,
regulation II-1/3-4;
MSC.1/Circ.1255

Construction drawings

A set of as-built construction drawings and other plans showing any subsequent structural alterations shall be kept on board a ship constructed on or after 1 January 2007.

SOLAS 1974,
regulation II-1/3-7;
MSC/Circ.1135

Ship Construction File

A Ship Construction File with specific information should be kept on board oil tankers of 150 m in length and above and bulk carriers of 150 m in length and above, constructed with single deck, top-side tanks and hopper side tanks in cargo spaces, excluding ore carriers and combination carriers:

SOLAS 1974,
regulation II-1/3-10;
MSC.1/Circ.1343

- .1 for which the building contract is placed on or after 1 July 2016;
- .2 in the absence of a building contract, the keels of which are laid or which are at a similar stage of construction on or after 1 July 2017; or
- .3 the delivery of which is on or after 1 July 2020 shall carry a Ship Construction File containing information in accordance with regulations and guidelines,

and updated as appropriate throughout the ship's life in order to facilitate safe operation, maintenance, survey, repair and emergency measures.

Noise Survey Report

Applicable to new ships of 1,600 gross tonnage and above, excluding dynamically supported crafts, high-speed crafts, fishing vessels, pipe-laying barges, crane barges, mobile offshore drilling units, pleasure yachts not engaged in trade, ships of war and troopships, ships not propelled by mechanical means, pile driving vessels and dredgers.

SOLAS 1974,
regulation II-1/3-12;
Noise Code, section 4.3

A noise survey report shall always be carried on board and be accessible for the crew.

For existing ships, refer to section "Other certificates and documents which are not mandatory – Noise Survey Report" (resolution A.468(XII)).

Stability information

Every passenger ship regardless of size and every cargo ship of 24 m and over shall be inclined on completion and the elements of their stability determined. The master shall be supplied with stability information containing such information as is necessary to enable him, by rapid and simple procedures, to obtain accurate guidance as to the stability of the ship under varying conditions of service to maintain the required intact stability and stability after damage. For bulk carriers, the information required in a bulk carrier booklet may be contained in the stability information.

SOLAS 1974,
regulations II-1/5 and II-1/5-1;
LL 1966, regulation 10;
LL Protocol 1988,
regulation 10

	<i>Reference</i>
<p><i>Damage control plans and booklets</i></p> <p>On passenger and cargo ships, there shall be permanently exhibited plans showing clearly for each deck and hold the boundaries of the watertight compartments, the openings therein with the means of closure and position of any controls thereof, and the arrangements for the correction of any list due to flooding. Booklets containing the aforementioned information shall be made available to the officers of the ship.</p>	SOLAS 1974, regulation II-1/19; MSC.1/Circ.1245
<p><i>Manoeuvring booklet</i></p> <p>The stopping times, ship headings and distances recorded on trials, together with the results of trials to determine the ability of ships having multiple propellers to navigate and manoeuvre with one or more propellers inoperative, shall be available on board for the use of the master or designated personnel.</p>	SOLAS 1974, regulation II-1/28
<p><i>Evaluation of the alternative design and arrangements</i></p> <p>Where applicable, a copy of the documentation, as approved by the Administration, indicating that the alternative design and arrangements comply with this regulation shall be carried onboard the ship.</p>	SOLAS 1974, regulations II-1/55.4.2, II-2/17.4.2, and III/38.4.2
<p><i>Maintenance plans</i></p> <p>The maintenance plan shall include the necessary information about fire protection systems and fire-fighting systems and appliances as required by regulation II-2/14.2.2. For tankers, additional requirements are referred to in regulation II-2/14.4.</p> <p>For passenger ships carrying more than 36 Passengers, the maintenance plan should include low-location lighting and public address system as required by SOLAS regulation II-2/14.3.</p>	SOLAS 1974, regulations II-2/14.2.2, II-2/14.3 and and II-2/14.4
<p><i>Onboard training and drills record</i></p> <p>Fire drills shall be conducted and recorded in accordance with the provisions of regulations III/19.3 and III/19.5.</p>	SOLAS 1974, regulation II-2/15.2.2.5
<p><i>Fire safety training manual</i></p> <p>A training manual shall be written in the working language of the ship and shall be provided in each crew mess room and recreation room or in each crew cabin. The manual shall contain the instructions and information required in regulation II-2/15.2.3.4. Part of such information may be provided in the form of audio-visual aids in lieu of the manual.</p>	SOLAS 1974, regulation II-2/15.2.3
<p><i>Fire control plan/booklet</i></p> <p>General arrangement plans shall be permanently exhibited for the guidance of the ship's officers, showing clearly for each deck the control stations, the various fire sections together with particulars of the fire detection and fire alarm systems and the fire-extinguishing appliances, etc. Alternatively, at the discretion of the Administration, the aforementioned details may be set out in a booklet, a copy of which shall be supplied to each officer, and one copy shall at all times be available on board in an accessible position. Plans and booklets shall be kept up to date; any alterations shall be recorded as soon as practicable. A duplicate set of fire control plans or a booklet containing such plans shall be permanently stored in a prominently marked weathertight enclosure outside the deckhouse for the assistance of shoreside fire-fighting personnel.</p>	SOLAS 1974, regulations II-2/15.2.4 and II-2/15.3.2

Reference

Fire safety operational booklet

The fire safety operational booklet shall contain the necessary information and instructions for the safe operation of the ship and cargo handling operations in relation to fire safety. The booklet shall be written in the working language of the ship and be provided in each crew mess room and recreation room or in each crew cabin. The booklet may be combined with the fire safety training manuals required in regulation II-2/15.2.3.

SOLAS 1974,
regulation II-2/16.2

Operations manual for helicopter facility

Each helicopter facility, if fitted, shall have an operations manual, including a description and a checklist of safety precautions, procedures and equipment requirements. This manual may be part of the ship's emergency response procedures

SOLAS 1974,
regulation II-2/18.8.1

Statement of acceptance of the installation of replacement release and retrieval system to an existing lifeboat

For all ships, no later than the first scheduled dry-docking after 1 July 2014, but no later than 1 July 2019, lifeboat on-load release mechanisms not complying with paragraphs 4.4.7.6.4 to 4.4.7.6.6 of the LSA Code shall be replaced with equipment that complies with the Code.

SOLAS 1974,
regulation III/1.5;
LSA Code, para. 4.4.7.6;
MSC.1/Circ.1392/Corr.1

Muster list and emergency instructions

All ships shall be provided with muster list and emergency instructions, which shall comply with the requirements of regulation 37 and be exhibited in conspicuous places throughout the ship including the navigation bridge, engine-room and crew accommodation spaces. In the case of passenger ships, these instructions shall be drawn up in the language(s) required by its flag State and in the English language.

SOLAS 1974,
regulations III/8 and III/37

Ship-specific Plans and Procedures for Recovery of Persons from the Water

All ships shall have ship-specific plans and procedures for recovery of persons from the water. Ships constructed before 1 July 2014 shall comply with this requirement by the first periodical or renewal safety equipment survey of the ship to be carried out after 1 July 2014, whichever comes first.

SOLAS 1974
regulation III/17-1;
resolution MSC.346(91);
MSC.1/Circ.1447

Ro-ro passenger ships which comply with regulation III/26.4 shall be deemed to comply with this regulation.

The Plans and Procedures should be considered as a part of the emergency preparedness plan required by paragraph 8 of the ISM Code.

Training manual

The training manual, which may comprise several volumes, shall contain instructions and information, in easily understood terms illustrated wherever possible, on the life-saving appliances provided in the ship and on the best methods of survival. Any part of such information may be provided in the form of audio-visual aids in lieu of the manual.

SOLAS 1974,
regulation III/35

Radio record

A record shall be kept, to the satisfaction of the Administration and as required by the Radio Regulations, of all incidents connected with the radiocommunication service which appear to be of importance to safety of life at sea.

SOLAS 1974,
regulation IV/17

	<i>Reference</i>
<p><i>Minimum safe manning document</i> Every ship to which chapter I of the Convention applies shall be provided with an appropriate safe manning document or equivalent issued by the Administration as evidence of the minimum safe manning.</p>	<p>SOLAS 1974, regulation V/14.2</p>
<p><i>Voyage data recorder system – certificate of compliance</i> The voyage data recorder system, including all sensors, shall be subjected to an annual performance test. The test shall be conducted by an approved testing or servicing facility to verify the accuracy, duration and recoverability of the recorded data. In addition, tests and inspections shall be conducted to determine the serviceability of all protective enclosures and devices fitted to aid location. A copy of the certificate of compliance issued by the testing facility, stating the date of compliance and the applicable performance standards, shall be retained on board the ship.</p>	<p>SOLAS 1974, regulation V/18.8</p>
<p><i>AIS test report</i> The Automatic Identification System (AIS) shall be subjected to an annual test by an approved surveyor or an approved testing or servicing facility. A copy of the test report shall be retained on board and should be in accordance with a model form set out in the annex to MSC.1/Circ.1252.</p>	<p>SOLAS 1974, regulation V/18.9; MSC.1/Circ.1252</p>
<p><i>Nautical charts and nautical publications</i> Nautical charts and nautical publications for the intended voyage shall be adequate and up to date. An electronic chart display and information system (ECDIS) is also accepted as meeting the chart carriage requirements of this subparagraph.</p>	<p>SOLAS 1974, regulations V/19.2.1.4 and V/27</p>
<p><i>LRIT conformance test report</i> A Conformance test report should be issued, on satisfactory completion of a conformance test, by the Administration or the ASP who conducted the test acting on behalf of the Administration and should be in accordance with the model set out in appendix 2 of MSC.1/Circ.1307.</p>	<p>SOLAS 1974, regulation V/19-1; MSC.1/Circ.1307</p>
<p><i>International Code of Signals and a copy of Volume III of IAMSAR Manual</i> All ships required to carry a radio installation shall carry the International Code of Signal; all ships shall carry an up-to-date copy of Volume III of the International Aeronautical and Maritime Search and Rescue (IAMSAR) Manual.</p>	<p>SOLAS 1974, regulation V/21</p>
<p><i>Records for pilot ladders used for pilot transfer</i> All pilot ladders used for pilot transfer shall be clearly identified with tags or other permanent marking so as to enable identification of each appliance for the purposes of survey, inspection and record keeping. A record shall be kept on the ship as to the date the identified ladder is placed into service and any repairs effected.</p>	<p>SOLAS 1974, regulation V/23.2.4</p>
<p><i>Records of navigational activities</i> All ships engaged on international voyages shall keep on board a record of navigational activities and incidents including drills and pre-departure tests. When such information is not maintained in the ship's logbook, it shall be maintained in another form approved by the Administration.</p>	<p>SOLAS 1974, regulations V/26 and V/28.1</p>

*Reference**Cargo Securing Manual*

All cargoes other than solid and liquid bulk cargoes, cargo units and cargo transport units, shall be loaded, stowed and secured throughout the voyage in accordance with the Cargo Securing Manual approved by the Administration. In ships with ro-ro spaces, as defined in regulation II-2/3.41, all securing of such cargoes, cargo units and cargo transport units, in accordance with the Cargo Securing Manual, shall be completed before the ship leaves the berth. The Cargo Securing Manual is required on all types of ships engaged in the carriage of all cargoes other than solid and liquid bulk cargoes, which shall be drawn up to a standard at least equivalent to the guidelines developed by the Organization.

SOLAS 1974,
regulations VI/5.6 and VII/5;
MSC.1/Circ.1353/Rev.1

Material Safety Data Sheets (MSDS)

Ships carrying oil or oil fuel, as defined in regulation 1 of Annex I of the International Convention for the Prevention of Pollution from Ships, 1973, as modified by the Protocol of 1978 relating thereto, shall be provided with material safety data sheets, based on the recommendations developed by the Organization, prior to the loading of such oil as cargo in bulk or bunkering of oil fuel.

SOLAS 1974,
regulation VI/5-1;
resolution MSC.286(86)

Safety Management Certificate

A Safety Management Certificate shall be issued to every ship by the Administration or an organization recognized by the Administration. The Administration or an organization recognized by it shall, before issuing the Safety Management Certificate, verify that the company and its shipboard management operate in accordance with the approved safety management system.

SOLAS 1974,
regulation IX/4;
ISM Code, paragraph 13

Document of Compliance

A document of compliance shall be issued to every company which complies with the requirements of the ISM Code. A copy of the document shall be kept on board.

SOLAS 1974,
regulation IX/4;
ISM Code, paragraph 13

Continuous Synopsis Record (CSR)

Every ship to which chapter I of the Convention applies shall be issued with a Continuous Synopsis Record. The Continuous Synopsis Record provides an onboard record of the history of the ship with respect to the information recorded therein.

SOLAS 1974,
regulation XI-1/5

Reference

Ship Security Plan and associated records

Each ship shall carry on board a ship security plan approved by the Administration. The plan shall make provisions for the three security levels as defined in part A of the ISPS Code. Records of the following activities addressed in the ship security plan shall be kept on board for at least the minimum period specified by the Administration:

SOLAS 1974,
regulation XI-2/9;
ISPS Code, part A,
sections 9 and 10

- .1 training, drills and exercises;
- .2 security threats and security incidents;
- .3 breaches of security;
- .4 changes in security level;
- .5 communications relating to the direct security of the ship such as specific threats to the ship or to port facilities the ship is, or has been, in;
- .6 internal audits and reviews of security activities;
- .7 periodic review of the ship security assessment;
- .8 periodic review of the ship security plan;
- .9 implementation of any amendments to the plan; and
- .10 maintenance, calibration and testing of any security equipment provided on board, including testing of the ship security alert system.

International Ship Security Certificate (ISSC) or Interim International Ship Security Certificate

An International Ship Security Certificate (ISSC) shall be issued to every ship by the Administration or an organization recognized by it to verify that the ship complies with the maritime security provisions of SOLAS chapter XI-2 and part A of the ISPS Code. An interim ISSC may be issued under the ISPS Code, part A, section 19.4.

SOLAS 1974,
regulation XI-2/9.1.1;
ISPS Code, part A, section 19
and appendices

International Oil Pollution Prevention Certificate

An international Oil Pollution Prevention Certificate shall be issued, after survey in accordance with regulation 6 of Annex I of MARPOL, to any oil tanker of 150 gross tonnage and above and any other ship of 400 gross tonnage and above which is engaged in voyages to ports or offshore terminals under the jurisdiction of other Parties to MARPOL. The certificate is supplemented with a Record of Construction and Equipment for Ships other than Oil Tankers (Form A) or a Record of Construction and Equipment for Oil Tankers (Form B), as appropriate.

MARPOL Annex I,
regulation 7

Oil Record Book

Every oil tanker of 150 gross tonnage and above and every ship of 400 gross tonnage and above other than an oil tanker shall be provided with an Oil Record Book, Part I (Machinery space operations). Every oil tanker of 150 gross tonnage and above shall also be provided with an Oil Record Book, Part II (Cargo/ballast operations).

MARPOL Annex I,
regulations 17 and 36

	<i>Reference</i>
<p><i>Shipboard Oil Pollution Emergency Plan</i> Every oil tanker of 150 gross tonnage and above and every ship other than an oil tanker of 400 gross tonnage and above shall carry on board a Shipboard Oil Pollution Emergency Plan approved by the Administration.</p>	<p>MARPOL Annex I, regulation 37; resolution MEPC.54(32), as amended by resolution MEPC.86(44)</p>
<p><i>International Sewage Pollution Prevention Certificate</i> An International Sewage Pollution Prevention Certificate shall be issued, after an initial or renewal survey in accordance with the provisions of regulation 4 of Annex IV of MARPOL, to any ship which is required to comply with the provisions of that Annex and is engaged in voyages to ports or offshore terminals under the jurisdiction of other Parties to the Convention.</p>	<p>MARPOL Annex IV, regulation 5; MEPC/Circ.408</p>
<p><i>Document of approval for the rate of sewage discharge</i> Untreated sewage from ships other than passenger ships in all areas and from passenger ships outside special areas that has been stored in holding tanks shall be discharged at a moderate rate approved by the Administration based upon the standards developed by the Organization.</p>	<p>MARPOL Annex IV, regulation 11.1.1; resolution MEPC.157(55)</p>
<p><i>Garbage Management Plan</i> Every ship of 100 gross tonnage and above and every ship which is certified to carry 15 persons or more shall carry a garbage management plan which the crew shall follow.</p>	<p>MARPOL Annex V, regulation 10; resolution MEPC.220(63)</p>
<p><i>Garbage Record Book</i> Every ship of 400 gross tonnage and above and every ship which is certified to carry 15 persons or more engaged in voyages to ports or offshore terminals under the jurisdiction of other Parties to the Convention and every fixed and floating platform engaged in exploration and exploitation of the seabed shall be provided with a Garbage Record Book.</p>	<p>MARPOL Annex V, regulation 10</p>
<p><i>International Air Pollution Prevention Certificate</i> Ships constructed before the date of entry into force of the Protocol of 1997 shall be issued with an International Air Pollution Prevention Certificate. Any ship of 400 gross tonnage and above engaged in voyages to ports or offshore terminals under the jurisdiction of other Parties and platforms and drilling rigs engaged in voyages to waters under the sovereignty or jurisdiction of other Parties to the Protocol of 1997 shall be issued with an International Air Pollution Prevention Certificate.</p>	<p>MARPOL Annex VI, regulation 6</p>
<p><i>International Energy Efficiency Certificate</i> An International Energy Efficiency Certificate for the ship shall be issued after a survey in accordance with the provisions of regulation 5.4 to any ships of 400 gross tonnage and above before that ship may engage in voyages to ports or offshore terminals under the jurisdiction of other Parties.</p>	<p>MARPOL Annex VI, regulation 6</p>
<p><i>Ozone-depleting Substances Record Book</i> Each ship subject to MARPOL Annex VI, regulation 6.1 that has rechargeable systems that contain ozone-depleting substances shall maintain an ozone-depleting substances record book.</p>	<p>MARPOL Annex VI, regulation 12.6</p>

	Reference
<p><i>Fuel Oil Changeover Procedure and Logbook (record of fuel changeover)</i> Those ships using separate fuel oils to comply with MARPOL Annex VI, regulation 14.3 and entering or leaving an emission control area shall carry a written procedure showing how the fuel oil changeover is to be done. The volume of low-sulphur fuel oils in each tank as well as the date, time and position of the ship when any fuel oil changeover operation is completed prior to the entry into an emission control area or commenced after exit from such an area shall be recorded in such logbook as prescribed by the Administration.</p>	MARPOL Annex VI, regulation 14.6
<p><i>Manufacturer's Operating Manual for Incinerators</i> Incinerators installed in accordance with the requirements of MARPOL Annex VI, regulation 16.6.1 shall be provided with a Manufacturer's Operating Manual, which is to be retained with the unit.</p>	MARPOL Annex VI, regulation 16.7
<p><i>Bunker Delivery Note and Representative Sample</i> Bunker Delivery Note and representative sample of the fuel oil delivered shall be kept on board in accordance with requirements of MARPOL Annex VI, regulations 18.6 and 18.8.1.</p>	MARPOL Annex VI, regulations 18.6 and 18.8.1
<p><i>EEDI Technical File</i> Applicable to ships falling into one or more of the categories in MARPOL Annex VI, regulations 2.25 to 2.35.</p>	MARPOL Annex VI, regulation 20
<p><i>Ship Energy Efficiency Management Plan (SEEMP)</i> All ships of 400 gross tonnage and above, excluding platforms (including FPSOs and FSUs) and drilling rigs, regardless of their propulsion, shall keep on board a ship specific Ship Energy Efficiency Management Plan (SEEMP). This may form part of the ship's Safety Management System (SMS).</p>	MARPOL Annex VI, regulation 22; MEPC.1/Circ.795
<p><i>Technical File</i> Every marine diesel engine installed on board a ship shall be provided with a Technical File. The Technical File shall be prepared by the applicant for engine certification and approved by the Administration, and is required to accompany an engine throughout its life on board ships. The Technical File shall contain the information as specified in paragraph 2.4.1 of the NO_x Technical Code, 2008.</p>	NO _x Technical Code 2008, paragraph 2.3.4
<p><i>Record Book of Engine Parameters</i> Where the Engine Parameter Check method in accordance with paragraph 6.2 of the NO_x Technical Code, 2008 is used to verify compliance, if any adjustments or modifications are made to an engine after its pre-certification, a full record of such adjustments or modifications shall be recorded in the engine's Record Book of Engine Parameters.</p>	NO _x Technical Code 2008, paragraph 2.3.7

Reference

Certificates for masters, officers or ratings

Certificates for masters, officers or ratings shall be issued to those candidates who, to the satisfaction of the Administration, meet the requirements for service, age, medical fitness, training, qualifications and examinations in accordance with the appropriate provisions of the 1978 STCW Convention and STCW Code. Formats of certificates are given in section A-I/2 of the STCW Code. Certificates must be kept available in their original form on board the ships on which the holder is serving.

STCW 1978, article VI,
regulation I/2;
STCW Code, section A-I/2

Fishing vessel personnel serving on board seagoing fishing vessels shall be certificated in accordance with the provisions of STCW-F Convention 1995. Formats of certificates are given in the appendix 1, 2 and 3 of the Convention.

STCW-F 1995, article 6,
regulation 3

Records of daily hours of rest

Records of daily hours of rest of seafarers shall be maintained on board.

STCW Code, section A-VIII/1;
IMO/ILO Guidelines for the
development of tables of
seafarers' shipboard working
arrangements and formats of
records of seafarers' hours of
work or hours of rest

International Anti-fouling System Certificate

Ships of 400 GT and above engaged in international voyages, excluding fixed or floating platforms, FSUs and FPSOs, shall be issued after inspection and survey an international Anti-fouling System Certificate together with a Record of Anti-fouling Systems.

AFS 2001,
regulation 2(1) of annex 4

Declaration on Anti-fouling System

Ships of 24 m or more in length, but less than 400 GT engaged in international voyages, excluding fixed or floating platforms, FSUs, and FPSOs, shall carry a declaration signed by the owner or owner's authorized agents. Such a declaration shall be accompanied by appropriate documentation (such as a paint receipt or a contractor invoice) or contain appropriate endorsement.

AFS 2001,
regulation 5(1) of annex 4

International Ballast Water Management Certificate

Ships of 400 gross tonnage and above to which the BWM 2004 applies, excluding floating platforms, FSUs and FPSOs, shall be issued the certificate after successful completion of a survey conducted in accordance with regulation E-1.

BWM 2004, regulation E-2

Note: The item was added by the Secretariat as per the relevant requirements of the International Convention for the Control and Management of Ships' Ballast Water and Sediments, 2004 (BWM 2004), which will enter into force on 8 September 2017.

Reference

Ballast Water Management Plan

Each ship shall have on board and implement a ballast water management plan. Such a plan shall be approved by the Administration taking into account guidelines developed by the Organization.

BWM 2004, regulation B-1;
resolution MEPC.127(53)

Note: The item was added by the Secretariat as per the relevant requirements of the International Convention for the Control and Management of Ships' Ballast Water and Sediments, 2004 (BWM 2004), which will enter into force on 8 September 2017

Ballast Water Record Book

Each ship shall have on board a ballast water record book that may be an electronic record system, or that may be integrated into another record book or system and which shall at least contain the information specified in appendix II of the Convention. The ballast water record book entries shall be maintained on board the ship for a minimum period of two years after the last entry has been made and thereafter in the Company's control for a minimum period of three years.

BWM 2004, regulation B-2

Note: The item was added by the Secretariat as per relevant requirements of the International Convention for the Control and Management of Ships' Ballast Water and Sediments, 2004 (BWM 2004), which will enter into force on 8 September 2017.

Certificate of insurance or other financial security in respect of civil liability for bunker oil pollution damage

Certificate attesting that insurance or other financial security is in force in accordance with the provisions of this Convention shall be issued to each ship having a gross tonnage greater than 1,000 after the appropriate authority of a State Party has determined that the requirements of article 7, paragraph 1 have been complied with. With respect to a ship registered in a State Party such certificate shall be issued or certified by the appropriate authority of the State of the ship's registry; with respect to a ship not registered in a State Party it may be issued or certified by the appropriate authority of any State Party. A State Party may authorize either an institution or an organization recognized by it to issue the certificate referred to in article 7, paragraph 2. This compulsory insurance certificate shall be in the form of the model set out in the annex to the Convention.

Bunkers 2001, article 7

Certificate of insurance or other financial security in respect of liability for the removal of wrecks

Certificate attesting that insurance or other financial security is in force in accordance with the provisions of the Convention shall be issued to each ship of 300 gross tonnage and above by the appropriate authority of the State of the ship's registry after determining that the requirements of article 12.1 have been complied with. With respect to a ship registered in a State Party, such certificate shall be issued or certified by the appropriate authority of the State of the ship's registry; with respect to a ship not registered in a State Party it may be issued or certified by the appropriate authority of any State Party. This compulsory insurance certificate shall be in the form of the model set out in the annex to the Convention.

Nairobi WRC 2007,
article 12

Reference

2 In addition to the certificates listed in section 1 above, passenger ships shall carry:*Passenger Ship Safety Certificate*

A certificate called a Passenger Ship Safety Certificate shall be issued after inspection and survey to a passenger ship which complies with the requirements of chapters II-1, II-2, III, IV and V and any other relevant requirements of SOLAS 1974. A Record of Equipment for the Passenger Ship Safety Certificate (Form P) shall be permanently attached.

SOLAS 1974, regulation I/12;
SOLAS PROT 1988,
regulation I/12

Decision support system for masters

In all passenger ships, a decision support system for emergency management shall be provided on the navigation bridge.

SOLAS 1974,
regulation III/29

Search and rescue cooperation plan

Passenger ships to which chapter I of the Convention applies shall have on board a plan for cooperation with appropriate search and rescue services in event of an emergency.

SOLAS 1974,
regulation V/7.3

List of operational limitations

Passenger ships to which chapter I of the Convention applies shall keep on board a list of all limitations on the operation of the ship, including exemptions from any of the SOLAS regulations, restrictions in operating areas, weather restrictions, sea state restrictions, restrictions in permissible loads, trim, speed and any other limitations, whether imposed by the Administration or established during the design or the building stages.

SOLAS 1974, regulation V/30

Special Trade Passenger Ship Safety Certificate, Special Trade Passenger Ship Space Certificate

A Special Trade Passenger Ship Safety Certificate issued under the provisions of the Special Trade Passenger Ships Agreement, 1971.

STP 71, rule 5

A certificate called a Special Trade Passenger Ship Space Certificate shall be issued under the provisions of the Protocol on Space Requirements for Special Trade Passenger Ships, 1973.

SSTP 73, rule 5

Certificate of insurance or other financial security in respect of liability for the death of and personal injury to passengers

A certificate attesting that insurance or other financial security is in force in accordance with the provisions of this Convention shall be issued to each ship that is licensed to carry more than 12 passengers, after the appropriate authority of a State Party has determined that the requirements of article 4bis paragraph 1 have been complied with. With respect to a ship registered in a State Party, such certificate shall be issued or certified by the appropriate authority of the State of the ship's registry; with respect to a ship not registered in a State Party it may be issued or certified by the appropriate authority of any State Party. A State Party may authorize an institution or an organization recognized by it to issue the certificate. The certificate shall be in the form of the model set out in the annex to the Convention.

PAL 1974 as modified by
PAL PROT 2002, article 4bis;
resolution A.988(24);
Circular Letter No.2758

Pursuant to resolution A.988(24), States are recommended to ratify the Athens Protocol as soon as possible with the reservation that they reserve the right to issue and accept insurance certificates with such special exceptions and limitations as the insurance market conditions at the time of issue of the certificate may necessitate, examples being the biochemical clause and terrorism-related clauses (Circular Letter No.2758 refers).

3 In addition to the certificates listed in section 1 above, cargo ships shall carry:

Cargo Ship Safety Construction Certificate

A certificate called a Cargo Ship Safety Construction Certificate shall be issued after survey to a cargo ship of 500 gross tonnage and over which satisfies the requirements for cargo ships on survey, set out in regulation I/10 of SOLAS 1974, and complies with the applicable requirements of chapters II-1 and II-2, other than those relating to fire-extinguishing appliances and fire-control plans.

SOLAS 1974, regulation I/12;
SOLAS PROT 1988,
regulation I/12

Cargo Ship Safety Equipment Certificate

A certificate called a Cargo Ship Safety Equipment Certificate shall be issued after survey to a cargo ship of 500 gross tonnage and over which complies with the relevant requirements of chapters II-1 and II-2, III and V and any other relevant requirements of SOLAS 1974. A Record of Equipment for the Cargo Ship Safety Equipment Certificate (Form E) shall be permanently attached.

SOLAS 1974, regulation I/12;
SOLAS PROT 1988,
regulation I/12

Cargo Ship Safety Radio Certificate

A certificate called a Cargo Ship Safety Radio Certificate shall be issued after survey to a cargo ship of 300 gross tonnage and over, fitted with a radio installation, including those used in life-saving appliances, which complies with the requirements of chapter IV and any other relevant requirements of SOLAS 1974. A Record of Equipment for the Cargo Ship Safety Radio Certificate (Form R) shall be permanently attached.

SOLAS 1974, regulation I/12,
as amended by the
GMDSS amendments;
SOLAS PROT 1988,
regulation I/12

Cargo Ship Safety Certificate

A certificate called a Cargo Ship Safety Certificate may be issued after survey to a cargo ship which complies with the relevant requirements of chapters II-1, II-2, III, IV and V and other relevant requirements of SOLAS 1974 as modified by the 1988 SOLAS Protocol, as an alternative to the Cargo Ship Safety Construction Certificate, Cargo Ship Safety Equipment Certificate and Cargo Ship Safety Radio Certificate. A Record of Equipment for the Cargo Ship Safety Certificate (Form C) shall be permanently attached.

SOLAS PROT 1988,
regulation I/12

Ship Structure Access Manual

This regulation applies to oil tankers of 500 gross tonnage and over and bulk carriers, as defined in regulation IX/1, of 20,000 gross tonnage and over, constructed on or after 1 January 2006. A ship's means of access to carry out overall and close-up inspections and thickness measurements shall be described in a Ship Structure Access Manual approved by the Administration, an updated copy of which shall be kept on board.

SOLAS 1974,
regulation II-1/3-6

Cargo Information

The shipper shall provide the master or his representative with appropriate information, confirmed in writing, on the cargo, in advance of loading. In bulk carriers, the density of the cargo shall be provided in the above information.

SOLAS 1974,
regulations VI/2 and XII/10;
MSC/Circ.663

Reference

Bulk Carrier Booklet

To enable the master to prevent excessive stress in the ship's structure, the ship loading and unloading solid bulk cargoes shall be provided with a booklet referred to in SOLAS regulation VI/7.2. The booklet shall be endorsed by the Administration or on its behalf to indicate that SOLAS regulations XII/4, 5, 6 and 7, as appropriate, are complied with. As an alternative to a separate booklet, the required information may be contained in the stability information.

SOLAS 1974,
regulations VI/7 and XII/8;
BLU Code

Document of authorization for the carriage of grain and grain loading manual

A document of authorization shall be issued for every ship loaded in accordance with the regulations of the International Code for the Safe Carriage of Grain in Bulk. The document shall accompany or be incorporated into the grain loading manual provided to enable the master to meet the stability requirements of the Code.

SOLAS 1974, regulation VI/9;
Grain Code, section 3

Enhanced survey report file

Bulk carriers and oil tankers shall have a survey report file and supporting documents complying with paragraphs 6.2 and 6.3 of annex A/annex B, part A/part B, 2011 ESP Code.

SOLAS 1974,
regulation XI-1/2;
2011 ESP Code
(resolution A.1049(27),
as amended)

Dedicated Clean Ballast Tank Operation Manual

Every product carrier of 40,000 tonnes deadweight and above delivered on or before 1 June 1982, operating with dedicated clean ballast tanks shall be provided with a Dedicated Clean Ballast Tank Operation Manual detailing the system and specifying operational procedures. Such a Manual shall be to the satisfaction of the Administration and shall contain all the information set out in the Specifications referred to in subparagraph 8.2 of MARPOL Annex I regulation 18. If an alteration affecting the dedicated clean ballast tank system is made, the Operation Manual shall be revised accordingly.

MARPOL Annex I,
regulation 18.8;
resolution A.495(XII)

Condition Assessment Scheme (CAS) Statement of Compliance, CAS Final Report and Review Record

A Statement of Compliance shall be issued by the Administration to every oil tanker which has been surveyed in accordance with the requirements of the Condition Assessment Scheme (CAS) and found to be in compliance with these requirements. In addition, a copy of the CAS Final Report which was reviewed by the Administration for the issue of the Statement of Compliance and a copy of the relevant Review Record shall be placed on board to accompany the Statement of Compliance.

MARPOL Annex I,
regulations 20 and 21;
resolution MEPC.94(46), as
amended by
resolutions MEPC.99(48),
MEPC.112(50),
MEPC.131(53),
resolution MEPC.155(55),
and MEPC.236(65)

Subdivision and stability information

Every oil tanker to which regulation 28 of Annex I of MARPOL applies shall be provided in an approved form with information relative to loading and distribution of cargo necessary to ensure compliance with the provisions of this regulation and data on the ability of the ship to comply with damage stability criteria as determined by this regulation.

MARPOL Annex I,
regulation 28

Reference

Record of oil discharge monitoring and control system for the last ballast voyage

Subject to the provisions of paragraphs 4 and 5 of regulation 3 of MARPOL Annex I, every oil tanker of 150 gross tonnage and above shall be equipped with an oil discharge monitoring and control system approved by the Administration. The system shall be fitted with a recording device to provide a continuous record of the discharge in litres per nautical mile and total quantity discharged, or the oil content and rate of discharge. The record shall be identifiable as to time and date and shall be kept for at least three years.

MARPOL Annex I,
regulation 31

Oil Discharge Monitoring and Control (ODMC) Operational Manual

Every oil tanker fitted with an Oil Discharge Monitoring and Control system shall be provided with instructions as to the operation of the system in accordance with an operational manual approved by the Administration.

MARPOL Annex I,
regulation 31;
resolution A.496(XII);
resolution A.586(14),
as amended by
resolution MEPC.24(22);
resolution MEPC.108(49),
as amended by
resolution MEPC.240(65)

Crude Oil Washing Operations and Equipment Manual (COW Manual)

Every oil tanker operating with crude oil washing systems shall be provided with an Operations and Equipment Manual detailing the system and equipment and specifying operational procedures. Such a Manual shall be to the satisfaction of the Administration and shall contain all the information set out in the specifications referred to in regulation 35 of Annex I of MARPOL.

MARPOL Annex I,
regulation 35;
resolution MEPC.81(43)

STS Operations Plan and Records of STS Operations

Any oil tanker involved in STS operations shall carry on board a plan prescribing how to conduct STS operations (STS operations plan) not later than the date of the first annual, intermediate or renewal survey of the ship to be carried out on or after 1 January 2011. Each oil tanker's STS operations plan shall be approved by the Administration. The STS operations plan shall be written in the working language of the ship.

MARPOL Annex I,
regulation 41

Records of STS operations shall be retained on board for three years and be readily available for inspection.

VOC Management Plan

A tanker carrying crude oil, to which MARPOL Annex VI, regulation 15.1 applies, shall have on board and implement a VOC Management Plan.

MARPOL Annex VI,
regulation 15.6

Document of approval for the stability instrument

All ships, subject to the IBC, IGC, BCH and GC Codes, should be fitted with a stability instrument capable of verifying compliance with intact and damage stability approved by the Administration, at the first scheduled renewal survey of the ship on or after 1 January 2016, but not later than 1 January 2021, having regard to the performance standards recommended by the Organization. The Administration should issue a document of approval for the stability instrument.

IBC Code para. 2.2.6;
IGC Code para. 2.2.6;
BCH code para. 2.2.1.2;
GC Code para. 2.2.4;
2008 IS Code;
MSC.1/Circ.1229;
MSC.1/Circ.1461

Reference

Certificate of insurance or other financial security in respect of civil liability for oil pollution damage

A certificate attesting that insurance or other financial security is in force shall be issued to each ship carrying more than 2,000 tonnes of oil in bulk as cargo. It shall be issued or certified by the appropriate authority of the State of the ship's registry after determining that the requirements of article VII, paragraph 1, of the CLC Convention have been complied with.

CLC 1969, article VII

Certificate of insurance or other financial security in respect of civil liability for oil pollution damage

A certificate attesting that insurance or other financial security is in force in accordance with the provisions of the 1992 CLC Convention shall be issued to each ship carrying more than 2,000 tonnes of oil in bulk as cargo after the appropriate authority of a Contracting State has determined that the requirements of article VII, paragraph 1, of the Convention have been complied with. With respect to a ship registered in a Contracting State, such certificate shall be issued by the appropriate authority of the State of the ship's registry; with respect to a ship not registered in a Contracting State, it may be issued or certified by the appropriate authority of any Contracting State.

CLC 1992, article VII

4 In addition to the certificates listed in sections 1 and 3 above, where appropriate, any ship carrying noxious liquid chemical substances in bulk shall carry:

International Pollution Prevention Certificate for the Carriage of Noxious Liquid Substances in Bulk (NLS Certificate)

An international pollution prevention certificate for the carriage of noxious liquid substances in bulk (NLS Certificate) shall be issued, after survey in accordance with the provisions of regulation 8 of Annex II of MARPOL, to any ship carrying noxious liquid substances in bulk and which is engaged in voyages to ports or terminals under the jurisdiction of other Parties to MARPOL. In respect of chemical tankers, the Certificate of Fitness for the Carriage of Dangerous Chemicals in Bulk and the International Certificate of Fitness for the Carriage of Dangerous Chemicals in Bulk, issued under the provisions of the Bulk Chemical Code and International Bulk Chemical Code, respectively, shall have the same force and receive the same recognition as the NLS Certificate.

MARPOL Annex II, regulation 9

Cargo Record Book

Ships carrying noxious liquid substances in bulk shall be provided with a Cargo Record Book, whether as part of the ship's official log book or otherwise, in the form specified in appendix II to Annex II.

MARPOL Annex II, regulation 15.1

Procedures and Arrangements Manual (P & A Manual)

Every ship certified to carry noxious liquid substances in bulk shall have on board a Procedures and Arrangements Manual approved by the Administration.

MARPOL Annex II, regulation 14; resolution MEPC.18(22), as amended by resolution MEPC.62(35)

	<i>Reference</i>
<p><i>Shipboard Marine Pollution Emergency Plan for Noxious Liquid Substances</i> Every ship of 150 gross tonnage and above certified to carry noxious liquid substances in bulk shall carry on board a Shipboard Marine Pollution Emergency Plan For Noxious Liquid Substances approved by the Administration.</p>	MARPOL Annex II, regulation 17; resolution MEPC.85(44), as amended by resolution MEPC.137(53)
<p>5 In addition to the certificates listed in sections 1 and 3 above, where applicable, any chemical tanker shall carry:</p>	
<p><i>Certificate of Fitness for the Carriage of Dangerous Chemicals in Bulk</i> A certificate called a Certificate of Fitness for the Carriage of Dangerous Chemicals in Bulk, the model form of which is set out in the appendix to the Bulk Chemical Code, should be issued after an initial or periodical survey to a chemical tanker engaged in international voyages which complies with the relevant requirements of the Code.</p>	BCH Code, section 1.6
<p>Note: The Code is mandatory under Annex II of MARPOL for chemical tankers constructed before 1 July 1986.</p>	
<p>or</p>	
<p><i>International Certificate of Fitness for the Carriage of Dangerous Chemicals in Bulk</i> A certificate called an International Certificate of Fitness for the Carriage of Dangerous Chemicals in Bulk, the model form of which is set out in the appendix to the International Bulk Chemical Code, should be issued after an initial or periodical survey to a chemical tanker engaged in international voyages, which complies with the relevant requirements of the Code.</p>	IBC Code, section 1.5
<p>Note: The Code is mandatory under both chapter VII of SOLAS 1974 and Annex II of MARPOL for chemical tankers constructed on or after 1 July 1986.</p>	
<p>6 In addition to the certificates listed in sections 1 and 3 above, where applicable, any gas carrier shall carry:</p>	
<p><i>Certificate of Fitness for the Carriage of Liquefied Gases in Bulk</i> A certificate called a Certificate of Fitness for the Carriage of Liquefied Gases in Bulk, the model form of which is set out in the appendix to the Gas Carrier Code, should be issued after an initial or periodical survey to a gas carrier which complies with the relevant requirements of the Code.</p>	GC Code, section 1.6
<p><i>International Certificate of Fitness for the Carriage of Liquefied Gases in Bulk</i> A certificate called an International Certificate of Fitness for the Carriage of Liquefied Gases in Bulk, the model form of which is set out in the appendix to the International Gas Carrier Code, should be issued after an initial or periodical survey to a gas carrier which complies with the relevant requirements of the Code.</p>	IGC Code, section 1.4
<p>Note: The Code is mandatory under chapter VII of SOLAS 1974 for gas carriers constructed on or after 1 July 1986.</p>	

Reference

7 In addition to the certificates listed in sections 1, and 2 or 3 above, where applicable, any high-speed craft shall carry:*High-Speed Craft Safety Certificate*

A certificate called a High-Speed Craft Safety Certificate shall be issued after completion of an initial or renewal survey to a craft which complies with the requirements of the 1994 HSC Code or the 2000 HSC Code, as appropriate.

SOLAS 1974, regulation X/3;
1994 HSC Code, section 1.8;
2000 HSC Code, section 1.8

Permit to Operate High-Speed Craft

A certificate called a Permit to Operate High-Speed Craft shall be issued to a craft which complies with the requirements set out in paragraphs 1.2.2 to 1.2.7 of the 1994 HSC Code or the 2000 HSC Code, as appropriate.

1994 HSC Code, section 1.9;
2000 HSC Code, section 1.9

8 In addition to the certificates listed in sections 1, and 2 or 3 above, where applicable, any ship carrying dangerous goods shall carry:*Document of compliance with the special requirements for ships carrying dangerous goods*

The Administration shall provide the ship with an appropriate document as evidence of compliance of construction and equipment with the requirements of regulation II-2/19 of SOLAS 1974. Certification for dangerous goods, except solid dangerous goods in bulk, is not required for those cargoes specified as class 6.2 and 7 and dangerous goods in limited quantities.

SOLAS 1974,
regulation II-2/19.4

9 In addition to the certificates listed in sections 1, and 2 or 3 above, where applicable, any ship carrying dangerous goods in packaged form shall carry:*Transport information*

Transport information relating to the carriage of dangerous goods in packaged form and the container/vehicle packing certificate shall be in accordance with the relevant provisions of the IMDG Code and shall be made available to the person or organization designated by the port State authority.

SOLAS 1974,
regulation VII/4.1

Dangerous goods manifest or stowage plan

Each ship carrying dangerous goods in packaged form shall have a special list or manifest setting forth, in accordance with the classification set out in the IMDG Code, the dangerous goods on board and the location thereof. Each ship carrying dangerous goods in solid form in bulk shall have a list or manifest setting forth the dangerous goods on board and the location thereof. A detailed stowage plan, which identifies by class and sets out the location of all dangerous goods on board, may be used in place of such a special list or manifest. A copy of one of these documents shall be made available before departure to the person or organization designated by the port State authority.

SOLAS 1974,
regulations VII/4.2 and
VII/7-2.2;
MARPOL Annex III,
regulation 4

	Reference
<p>10 In addition to the certificates listed in sections 1, and 2 or 3 above, where applicable, any ship carrying INF cargo shall carry:</p> <p><i>International Certificate of Fitness for the Carriage of INF Cargo</i> A ship carrying INF cargo shall comply with the requirements of the International Code for the Safe Carriage of Packaged Irradiated Nuclear Fuel, Plutonium and High Level Radioactive Wastes on Board Ships (INF Code) in addition to any other applicable requirements of the SOLAS regulations and shall be surveyed and be provided with the International Certificate of Fitness for the Carriage of INF Cargo.</p>	<p>SOLAS 1974, regulation VII/16; INF Code (resolution MSC.88(71), as amended), paragraph 1.3</p>
<p>11 In addition to the certificates listed in sections 1, and 2 or 3 above, where applicable, any Nuclear ship shall carry:</p> <p><i>Operating Manual for nuclear power plant</i> A fully detailed Operating Manual shall be prepared for the information and guidance of the operating personnel in their duties on all matters relating to the operation of the nuclear power plant having an important bearing on safety. The Administration, when satisfied, shall approve such Operating Manual and a copy shall be kept on board the ship. The Operating Manual shall always be kept up to date.</p> <p><i>A Nuclear Cargo Ship Safety Certificate or Nuclear Passenger Ship Safety Certificate, in place of the Cargo Ship Safety Certificate or Passenger Ship Safety Certificate, as appropriate.</i> Every nuclear powered ship shall be issued with the certificate required by SOLAS chapter VIII.</p>	<p>SOLAS 1974, regulation VIII/8</p> <p>SOLAS 1974, regulation VIII/10</p>
<p>12 In addition to the certificates listed in sections 1, and 2 or 3 above, where applicable, any Ship operating in Polar waters shall carry:</p> <p><i>Polar Ship Certificate</i> Every ship to which the Polar Code applies shall have on board a valid Polar Ship Certificate. The certificate shall include a supplement recording equipment required by the Code.</p> <p><i>Polar Water Operational Manual (PWOM)</i> Every ship to which the Polar Code applies shall have on board a Polar Water Operational Manual (PWOM) as required in part I-A section 2.3 of the Code.</p>	<p>Polar Code, part I-A section 1.3</p> <p>Polar Code, part I-A section 2.3</p>

Other certificates and documents which are not mandatory

Special purpose ships

Special Purpose Ship Safety Certificate

In addition to SOLAS certificates as specified in paragraph 7 of the Preamble of the 1983 SPS Code and 2008 SPS Code, a Special Purpose Ship Safety Certificate should be issued after survey in accordance with the provisions of paragraph 1.6 of the 1983 SPS Code and 2008 SPS Code. The duration and validity of the certificate should be governed by the respective provisions for cargo ships in SOLAS 1974. If a certificate is issued for a special purpose ship of less than 500 gross tonnage, this certificate should indicate to what extent relaxations in accordance with 1.2 were accepted.

The 2008 SPS Code applies the every special purpose ship of not less than 500 GT certified on or after 13 May 2008.

1983 SPS Code
(resolution A.534(13),
as amended);
2008 SPS Code
(resolution MSC.266(84),
as amended),
SOLAS 1974, regulation I/12;
SOLAS PROT 1988,
regulation I/12

Offshore support vessels

Offshore Supply Vessel Document of Compliance

The Document of Compliance should be issued after satisfied that the vessel complies with the provisions of the Guidelines for the design and construction of Offshore Supply Vessels, 2006.

resolution MSC.235(82),
as amended by
resolution MSC.335(90)

Certificate of Fitness for Offshore Support Vessels

When carrying such cargoes, offshore support vessels should carry a Certificate of Fitness issued under the "Guidelines for the Transport and Handling of Limited Amounts of Hazardous and Noxious Liquid Substances in Bulk on Offshore Support Vessels". If an offshore support vessel carries only noxious liquid substances, a suitably endorsed International Pollution Prevention Certificate for the Carriage of Noxious Liquid Substances in Bulk may be issued instead of the above Certificate of Fitness.

resolution A.673(16),
as amended by
resolutions MSC.184(79),
MSC.236(82) and
MEPC.158(55);
MARPOL Annex II,
regulation 11.2

Diving systems

Diving System Safety Certificate

A certificate should be issued either by the Administration or any person or organization duly authorized by it after survey or inspection to a diving system which complies with the requirements of the Code of Safety for Diving Systems. In every case, the Administration should assume full responsibility for the certificate.

resolution A.831(19),
as amended by
resolution MSC.185(79),
section 1.6

Passenger submersible craft

Safety Compliance Certificate for Passenger Submersible Craft

Applicable to submersible craft adapted to accommodate passengers and intended for underwater excursions with the pressure in the passenger compartment at or near one atmosphere.

MSC/Circ.981, as amended
by MSC/Circ.1125

A Design and Construction Document issued by the Administration should be attached to the Safety Compliance Certificate.

Dynamically supported craft

Dynamically Supported Craft Construction and Equipment Certificate

To be issued after survey carried out in accordance with paragraph 1.5.1(a) of the Code of Safety for Dynamically Supported Craft.

DSC Code
(resolution A.373(X),
as amended) section 1.6

Reference

Mobile offshore drilling units

Mobile Offshore Drilling Unit Safety Certificate

To be issued after survey carried out in accordance with the provisions of the Code for the Construction and Equipment of Mobile Offshore Drilling Units, 1979, or, for units constructed on or after 1 May 1991, but before 1 January 2012, the Code for the Construction and Equipment of Drilling Units, 1989, or for units constructed on or after 1 January 2012, the Code for the Construction and Equipment of Drilling Units, 2009.

1979 MODU Code (resolution A.414(XI), as amended) section 1.6; 1989 MODU Code (resolution A.649(16), as amended) section 1.6; 2009 MODU Code (resolution A.1023(26), as amended), section 1.6

Wing-in-ground (WIG) Craft

Wing-in-ground Craft Safety Certificate

A certificate called a WIG Craft Safety Certificate should be issued after completion of an initial or renewal survey to a craft, which complies with the provisions of the Interim Guidelines for WIG craft.

MSC/Circ.1054, as amended by MSC/Circ.1126, section 9

Permit to Operate WIG Craft

A permit to operate should be issued by the Administration to certify compliance with the provisions of the Interim Guidelines for WIG craft.

MSC/Circ.1054, as amended by MSC/Circ.1126, section 10

Noise levels

Noise Survey Report

Applicable to existing ships to which SOLAS II-1/3-12 does not apply.

A noise survey report should be made for each ship in accordance with the Code on Noise Levels on Board Ships.

resolution A.468(XII), section 4.3

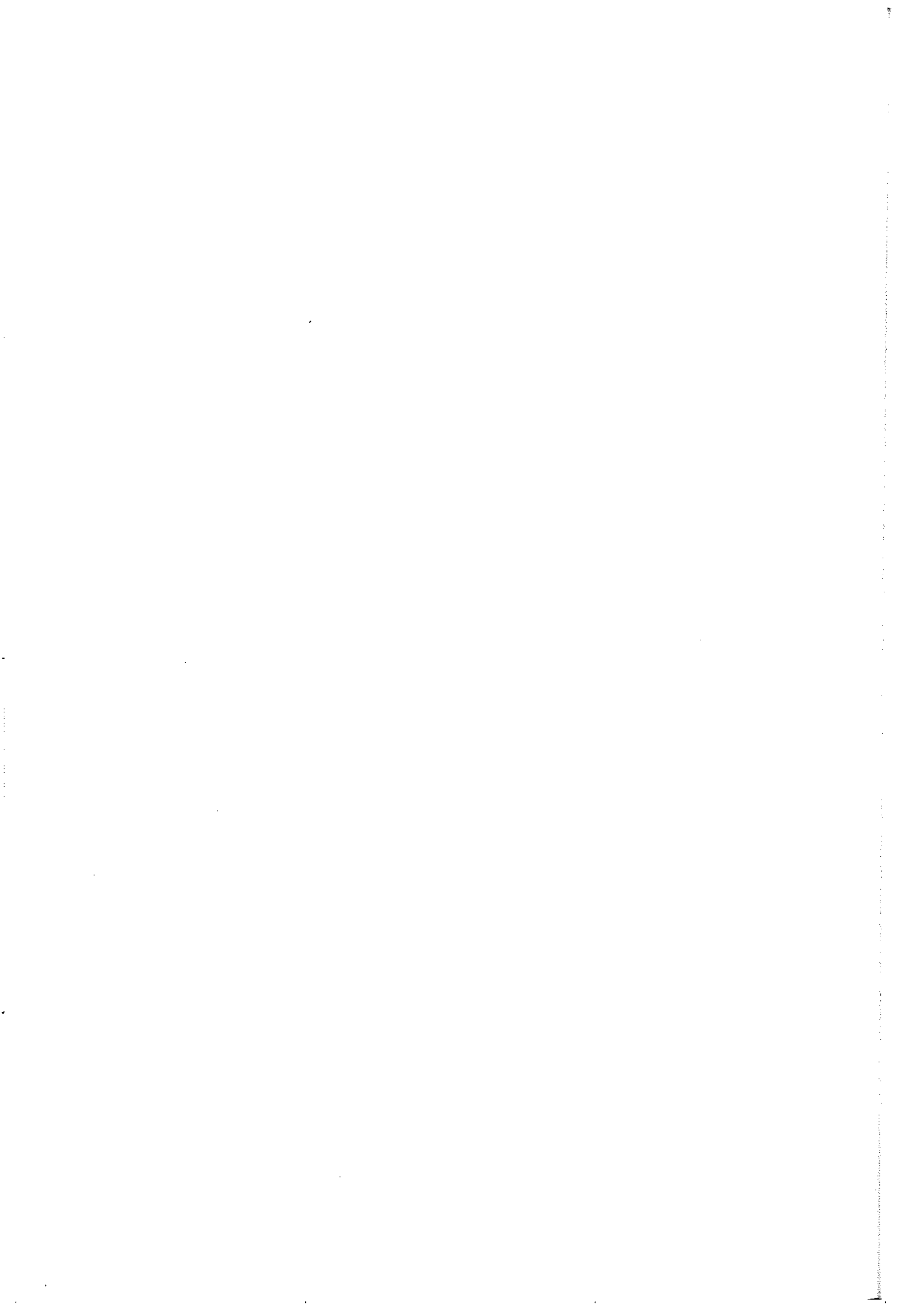

Annex 2

List of resolutions adopted by the SOLAS Conferences

International Conference on Safety of Life at Sea, 1974 (*October 1974*)

- Resolution 1 Comprehensive revision of the International Convention for the Safety of Life at Sea, 1974
- Resolution 2 Rapid amendment procedure and entry into force of the International Convention for the Safety of Life at Sea, 1974
- Resolution 3 Voting rights in the Maritime Safety Committee for the adoption of amendments
- Resolution 4 Recommendations of the 1960 Safety Conference and resolutions of the Assembly of the Organization related to regulations of the International Convention for the Safety of Life at Sea, 1974
- Resolution 5 Recommendations on the use of a system of units in the International Convention for the Safety of Life at Sea, 1974

Conference of Contracting Governments to the International Convention for the Safety of Life at Sea, 1974 (*May 1994*)

- Resolution 1 Adoption of amendments to the annex to the International Convention for the Safety of Life at Sea, 1974
- Resolution 2 Implementation of chapter IX of the 1974 SOLAS Convention on management for the safe operation of ships
- Resolution 3 Implementation of the International Safety Management (ISM) Code for cargo ships of less than 500 gross tonnage
- Resolution 4 Accelerated tacit acceptance procedure under the 1974 SOLAS Convention in exceptional circumstances
- Resolution 5 Future amendments to chapter XI of the 1974 SOLAS Convention on special measures to enhance maritime safety

Conference of Contracting Governments to the International Convention for the Safety of Life at Sea, 1974 (*November 1995*)

- Resolution 1 Adoption of amendments to the annex to the International Convention for the Safety of Life at Sea, 1974
- Resolution 2 Fire-extinguishing arrangements in machinery spaces of passenger ships
- Resolution 3 Escape arrangements in ships constructed before 1 July 1997
- Resolution 4 Maximum evacuation time for new ro-ro passenger ships
- Resolution 5 Amendments to chapter III of the 1974 SOLAS Convention
- Resolution 6 Low-powered radio homing devices for liferafts on ro-ro passenger ships
- Resolution 7 Development of requirements, guidelines and performance standards
- Resolution 8 Distress messages: obligations and procedures
- Resolution 9 Automatic ship identification transponder/transceiver systems
- Resolution 10 Establishment of working languages on ships

- Resolution 11 Operational limitations on passenger ships
- Resolution 12 Voyage data recorders
- Resolution 13 Cargo securing equipment
- Resolution 14 Regional agreements on specific stability requirements for ro-ro passenger ships

Conference of Contracting Governments to the International Convention for the Safety of Life at Sea, 1974 (November 1997)

- Resolution 1 Adoption of amendments to the annex to the International Convention for the Safety of Life at Sea, 1974
- Resolution 2 Adoption of amendments to the Guidelines on the enhanced programme of inspections during surveys of bulk carriers and oil tankers (resolution A.744(18))
- Resolution 3 Recommendation on compliance with SOLAS regulation XII/5
- Resolution 4 Standards for the evaluation of scantlings of the transverse watertight vertically corrugated bulkhead between the two foremost cargo holds and for the evaluation of allowable hold loading of the foremost cargo hold
- Resolution 5 Recommendation on loading instruments
- Resolution 6 Interpretation of the definition of "bulk carrier", as given in chapter IX of SOLAS 1974, as amended in 1994
- Resolution 7 Enhanced surveys carried out prior to entry into force of the amendments
- Resolution 8 Further work on the safety of bulk carriers
- Resolution 9 Implementation of the International Safety Management (ISM) Code

Conference of Contracting Governments to the International Convention for the Safety of Life at Sea, 1974 (December 2002)

- Resolution 1 Adoption of amendments to the Annex to the International Convention for the Safety of Life at Sea, 1974
- Resolution 2 Adoption of the International Code for the Security of Ships and of Port Facilities
- Resolution 3 Further work by the International Maritime Organization pertaining to the enhancement of maritime security
- Resolution 4 Future amendments to chapters XI-1 and XI-2 of the 1974 SOLAS Convention on special measures to enhance maritime safety and security
- Resolution 5 Promotion of technical cooperation and assistance
- Resolution 6 Early implementation of the special measures to enhance maritime security
- Resolution 7 Establishment of appropriate measures to enhance the security of ships, port facilities, mobile offshore drilling units on location and fixed and floating platforms not covered by chapter XI-2 of the 1974 SOLAS Convention
- Resolution 8 Enhancement of security in cooperation with the International Labour Organization
- Resolution 9 Enhancement of security in cooperation with the World Customs Organization
- Resolution 10 Early implementation of long-range ship's identification and tracking
- Resolution 11 Human-element-related aspects and shore leave for seafarers

Of all the international conventions dealing with maritime safety, the most important is the *International Convention for the Safety of Life at Sea*, better known as SOLAS, which covers a wide range of measures designed to improve the safety of shipping.

The Convention is also one of the oldest of its kind: the first version was adopted in 1914 following the sinking of the *Titanic* with the loss of more than 1,500 lives. Since then there have been four more versions of SOLAS. The present version was adopted in 1974 and entered into force in 1980.

In order to provide an easy reference to all SOLAS requirements applicable from **1 January 2020**, this edition presents a consolidated text of the Convention, its Protocols of 1978 and 1988 and all amendments in effect from that date. Additionally, this edition includes **Unified Interpretations to SOLAS regulations**, which were adopted by the Maritime Safety Committee.